

FEATURES

- Planar die construction.
- General purpose, medium current.
- Ideally suited for automated assembly processes.



APPLICATIONS

- Zener diode.
- Ultra-small surface mount package.

ORDERING INFORMATION

Type No.	Marking	Package Code
BZT52C2V4S-BZT52C51S	See table 2	SOD-323

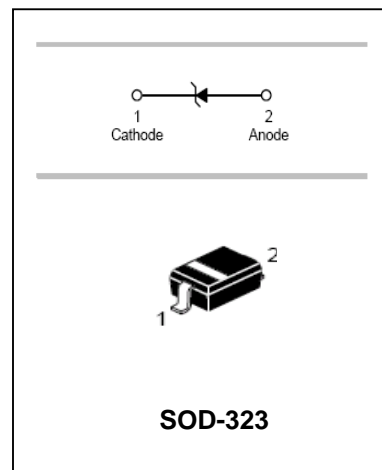

MAXIMUM RATING @ Ta=25°C unless otherwise specified

Characteristic	Symbol	Value	Unit
Forward Voltage @ I _F =10mA	V _F	0.9	V
Power Dissipation	P _d	200	mW
Thermal resistance, junction to ambient air	R _{θjA}	625	°C/W
Junction temperature	T _j	150	°C
Storage temperature range	T _{stg}	-65-150	°C

Notes: 1. Valid provided that device terminals are kept at ambient temperature.

2. Short duration test pulse used in minimize self-heating effect.

3. f = 1KHz.

Surface mount zener diode

BZT52C2V0S-BZT52C39S

Type Number	Marking Code	Zener Voltage Range				Maximum Zener Impedance			Maximum Reverse Current		Temperature Coefficient of zener voltage @ I_{ZTC} mV/°C	
		$V_Z@I_{ZT}$			I_{ZT}	$Z_{ZT}@I_{ZT}$	$Z_{ZK}@I_{ZK}$	I_{ZK}	I_R	@ V_R	Min	Max
		Nom(V)	Min(V)	Max(V)	mA	Ω	mA	μA	V			
BZT52C2V0S	WY	2.0	1.91	2.09	5	100	600	1.0	150	1.0	-3.5	0
BZT52C2V4S	WX	2.4	2.2	2.60	5	100	600	1.0	50	1.0	-3.5	0
BZT52C2V7S	W1	2.7	2.5	2.9	5	100	600	1.0	20	1.0	-3.5	0
BZT52C3V0S	W2	3.0	2.8	3.2	5	95	600	1.0	10	1.0	-3.5	0
BZT52C3V3S	W3	3.3	3.1	3.5	5	95	600	1.0	5	1.0	-3.5	0
BZT52C3V6S	W4	3.6	3.4	3.8	5	90	600	1.0	5	1.0	-3.5	0
BZT52C3V9S	W5	3.9	3.7	4.1	5	90	600	1.0	3	1.0	-3.5	0
BZT52C4V3S	W6	4.3	4.0	4.6	5	90	600	1.0	3	1.0	-3.5	0
BZT52C4V7S	W7	4.7	4.4	5.0	5	80	500	1.0	3	2.0	-3.5	0.2
BZT52C5V1S	W8	5.1	4.8	5.4	5	60	480	1.0	2	2.0	-2.7	1.2
BZT52C5V6S	W9	5.6	5.2	6.0	5	40	400	1.0	1	2.0	-2.0	2.5
BZT52C6V2S	WA	6.2	5.8	6.6	5	10	150	1.0	3	4.0	0.4	3.7
BZT52C6V8S	WB	6.8	6.4	7.2	5	15	80	1.0	2	4.0	1.2	4.5
BZT52C7V5S	WC	7.5	7.0	7.9	5	15	80	1.0	1	5.0	2.5	5.3
BZT52C8V2S	WD	8.2	7.7	8.7	5	15	80	1.0	0.7	5.0	3.2	6.2
BZT52C9V1S	WE	9.1	8.5	9.6	5	15	100	1.0	0.5	6.0	3.8	7.0
BZT52C10S	WF	10	9.4	10.6	5	20	150	1.0	0.2	7.0	4.5	8.0
BZT52C11S	WG	11	10.4	11.6	5	20	150	1.0	0.1	8.0	5.4	9.0
BZT52C12S	WH	12	11.4	12.7	5	25	150	1.0	0.1	8.0	6.0	10.0
BZT52C13S	WI	13	12.4	14.1	5	30	170	1.0	0.1	8.0	7.0	11.0
BZT52C15S	WJ	15	13.8	15.6	5	30	200	1.0	0.1	10.5	9.2	13.0
BZT52C16S	WK	16	15.3	17.1	5	40	200	1.0	0.1	11.2	10.4	14.0
BZT52C18S	WL	18	16.8	19.1	5	45	225	1.0	0.1	12.6	12.4	16.0
BZT52C20S	WM	20	18.8	21.2	5	55	225	1.0	0.1	14.0	14.4	18.0
BZT52C22S	WN	22	20.8	23.3	5	55	250	1.0	0.1	15.4	16.4	20.0
BZT52C24S	WO	24	22.8	25.6	5	70	250	1.0	0.1	16.8	18.4	22.0
BZT52C27S	WP	27	25.1	28.9	2	80	300	0.5	0.1	18.9	21.4	25.3
BZT52C30S	WQ	30	28.0	32.0	2	80	300	0.5	0.1	21.0	24.4	29.4
BZT52C33S	WR	33	31.0	35.0	2	80	325	0.5	0.1	23.1	27.4	33.4
BZT52C36S	WS	36	34.0	38.0	2	90	350	0.5	0.1	25.2	30.4	37.4
BZT52C39S	WT	39	37.0	41.0	2	130	350	0.5	0.1	27.3	33.4	41.2

Notes: 1. Valid provided that device terminals are kept at ambient temperature.

2. Tested with pulses, period=5ms, pulse width = 300 μ s.

3. f = 1KHz.

TYPICAL CHARACTERISTICS @ $T_a=25^\circ\text{C}$ unless otherwise specified

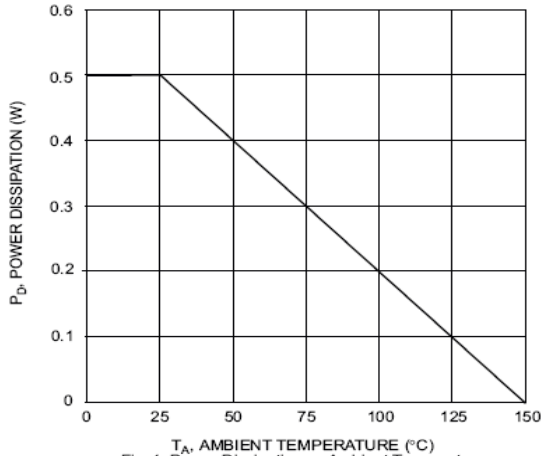

Fig. 1 Power Dissipation vs Ambient Temperature

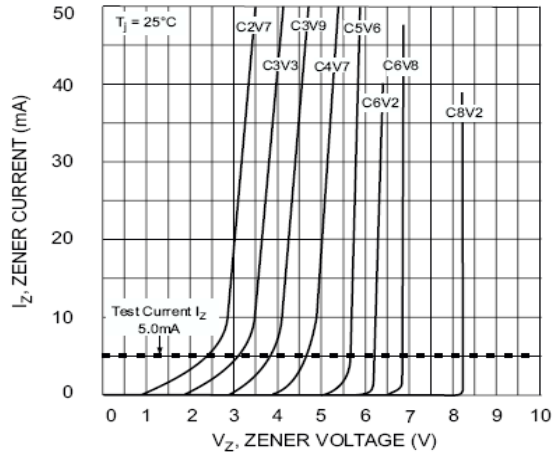

Fig. 2 Zener Breakdown Characteristics

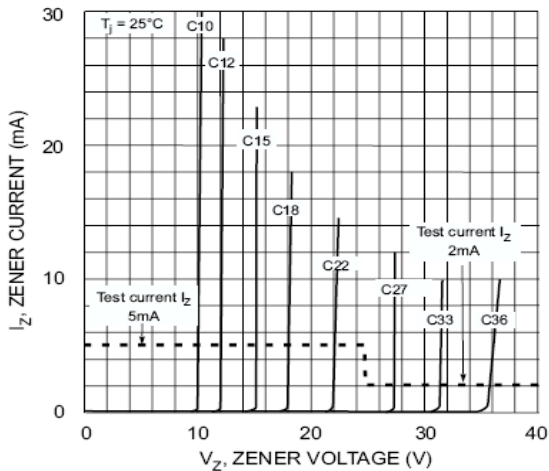

Fig. 3 Zener Breakdown Characteristics

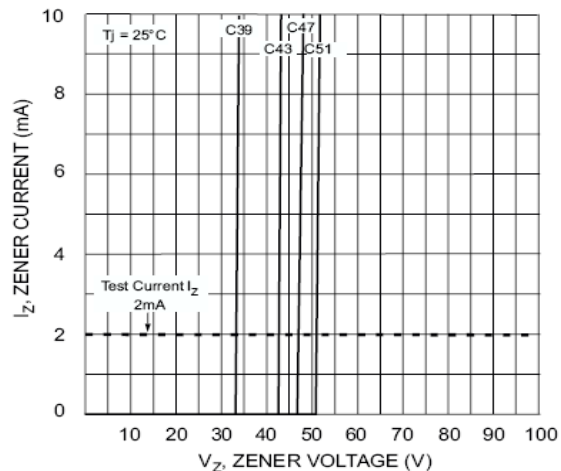

Fig. 4 Zener Breakdown Characteristics

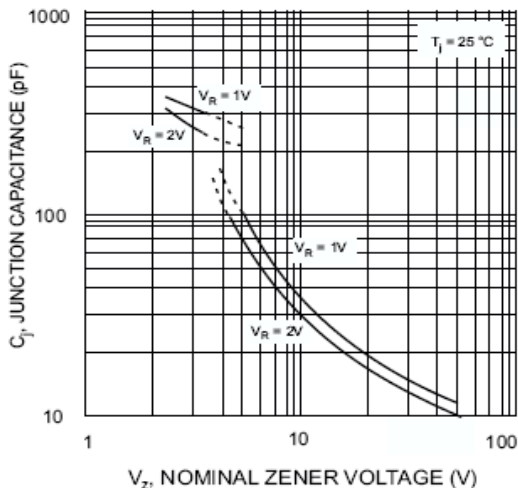

Fig. 5 Junction Capacitance vs Nominal Zener Voltage

Surface mount zener diode

BZT52C2V0S-BZT52C39S

PACKAGE OUTLINE

Plastic surface mounted package

SOD-323

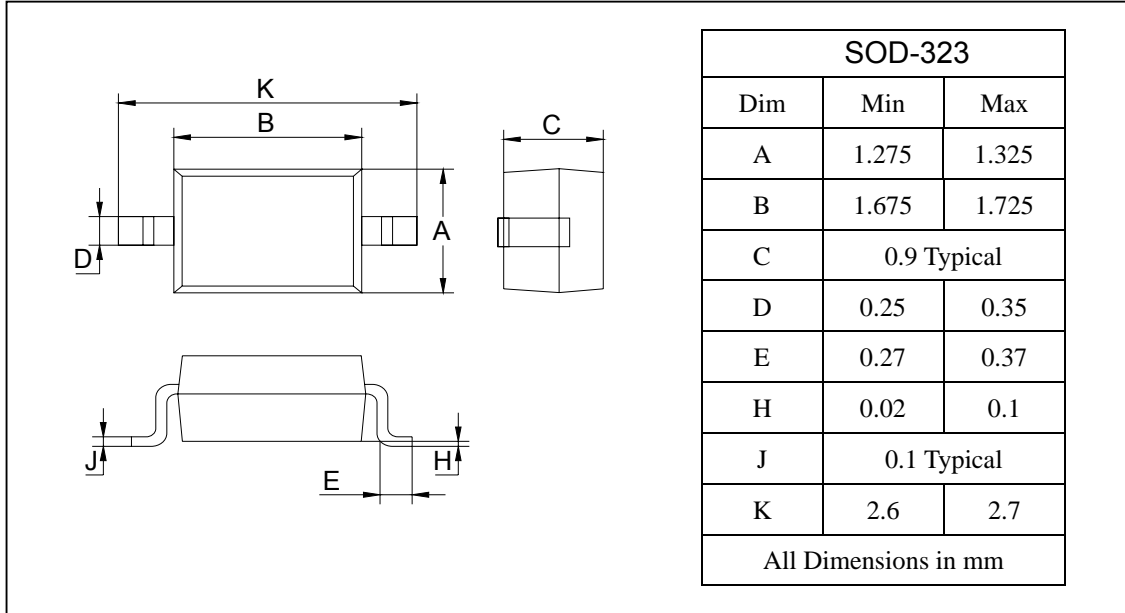

SOLDERING FOOTPRINT

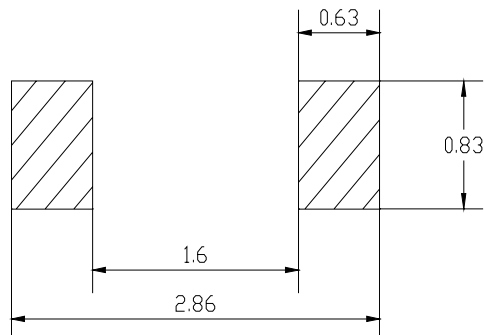

Unit : mm

PACKAGE INFORMATION

Device	Package	Shipping
BZT52C2V0S-BZT52C39S	SOD-323	3000/Tape&Reel