

Rectifier diodes fast, soft-recovery

BY329 series

FEATURES

- Low forward volt drop
- Fast switching
- Soft recovery characteristic
- High thermal cycling performance
- Low thermal resistance

SYMBOL

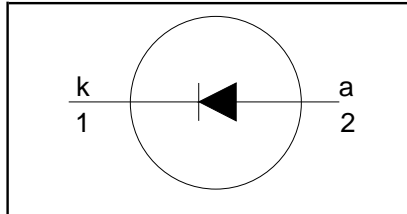

QUICK REFERENCE DATA

$$V_R = 800 \text{ V} / 1000 \text{ V} / 1200 \text{ V}$$

$$I_{F(AV)} = 8 \text{ A}$$

$$I_{FSM} \leq 75 \text{ A}$$

$$t_{rr} \leq 135 \text{ ns}$$

GENERAL DESCRIPTION

Glass-passivated double diffused rectifier diodes featuring low forward voltage drop, fast reverse recovery and soft recovery characteristic. The devices are intended for use in TV receivers, monitors and switched mode power supplies.

The BY329 series is supplied in the conventional leaded SOD59 (TO220AC) package.

PINNING

PIN	DESCRIPTION
1	cathode
2	anode
tab	cathode

SOD59 (TO220AC)

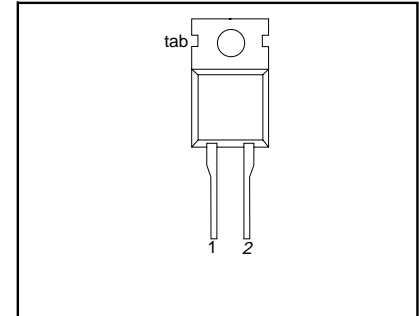

LIMITING VALUES

Limiting values in accordance with the Absolute Maximum System (IEC 134).

SYMBOL	PARAMETER	CONDITIONS	MIN.	MAX.			UNIT
				-800	-1000	-1200	
V_{RSM}	Peak non-repetitive reverse voltage	BY329	-	800	1000	1200	V
V_{RRM}	Peak repetitive reverse voltage		-	800	1000	1200	V
V_{RWM}	Crest working reverse voltage		-	600	800	1000	V
$I_{F(AV)}$	Average forward current ¹	square wave; $\delta = 0.5$; $T_{mb} \leq 122 \text{ }^\circ\text{C}$ sinusoidal; $a = 1.57$; $T_{mb} \leq 125 \text{ }^\circ\text{C}$	-	8			A
$I_{F(RMS)}$	RMS forward current	$t = 25 \text{ } \mu\text{s}$; $\delta = 0.5$; $T_{mb} \leq 122 \text{ }^\circ\text{C}$	-	11			A
I_{FRM}	Repetitive peak forward current		-	16			A
I_{FSM}	Non-repetitive peak forward current.	$t = 10 \text{ ms}$	-	75			A
		$t = 8.3 \text{ ms}$ sinusoidal; $T_j = 150 \text{ }^\circ\text{C}$ prior to surge; with reapplied	-	82			A
I^2t	I^2t for fusing	$V_{RWM(max)}$ $t = 10 \text{ ms}$	-	28			A ² s
T_{stg}	Storage temperature		-40	150			$^\circ\text{C}$
T_j	Operating junction temperature		-	150			$^\circ\text{C}$

¹ Neglecting switching and reverse current losses.

**Rectifier diodes
fast, soft-recovery**
BY329 series
THERMAL RESISTANCES

SYMBOL	PARAMETER	CONDITIONS	MIN.	TYP.	MAX.	UNIT
$R_{th\ j-mb}$	Thermal resistance junction to mounting base		-	-	2.0	K/W
$R_{th\ j-a}$	Thermal resistance junction to ambient	in free air.	-	60	-	K/W

STATIC CHARACTERISTICS
 $T_j = 25\text{ °C}$ unless otherwise stated

SYMBOL	PARAMETER	CONDITIONS	MIN.	TYP.	MAX.	UNIT
V_F	Forward voltage	$I_F = 20\text{ A}$	-	1.5	1.85	V
I_R	Reverse current	$V_R = V_{RWM}; T_j = 125\text{ °C}$	-	0.1	1.0	mA

DYNAMIC CHARACTERISTICS
 $T_j = 25\text{ °C}$ unless otherwise stated

SYMBOL	PARAMETER	CONDITIONS	MIN.	TYP.	MAX.	UNIT
t_{rr}	Reverse recovery time	$I_F = 1\text{ A}; V_R \geq 30\text{ V}; -di_F/dt = 50\text{ A}/\mu\text{s}$	-	100	135	ns
Q_s	Reverse recovery charge	$I_F = 2\text{ A}; V_R \geq 30\text{ V}; -di_F/dt = 20\text{ A}/\mu\text{s}$	-	0.5	0.7	μC
di_R/dt	Maximum slope of the reverse recovery current	$I_F = 2\text{ A}; -di_F/dt = 20\text{ A}/\mu\text{s}$	-	50	60	$\text{A}/\mu\text{s}$

Rectifier diodes
fast, soft-recovery

BY329 series

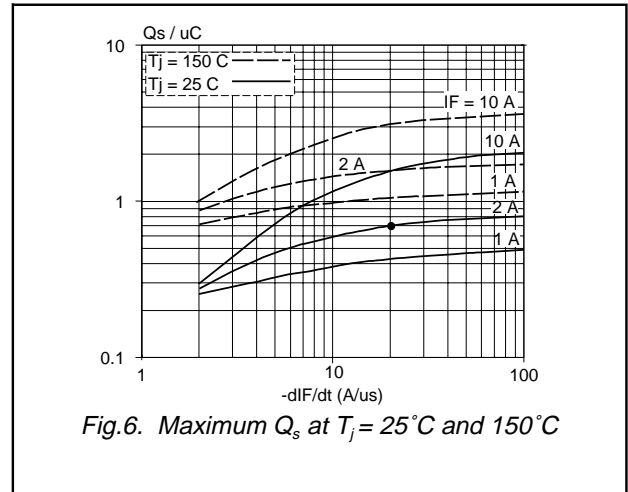
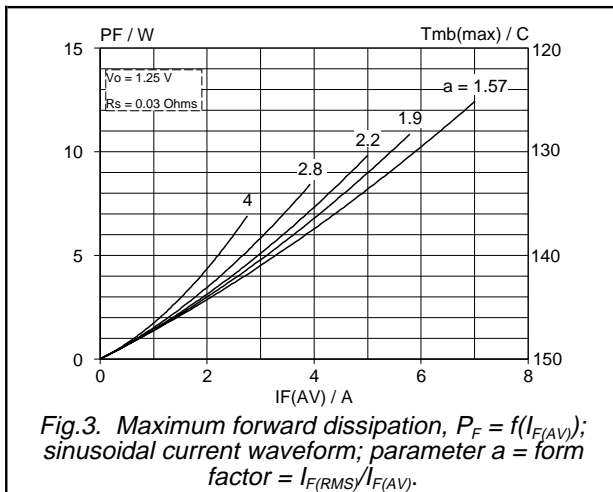
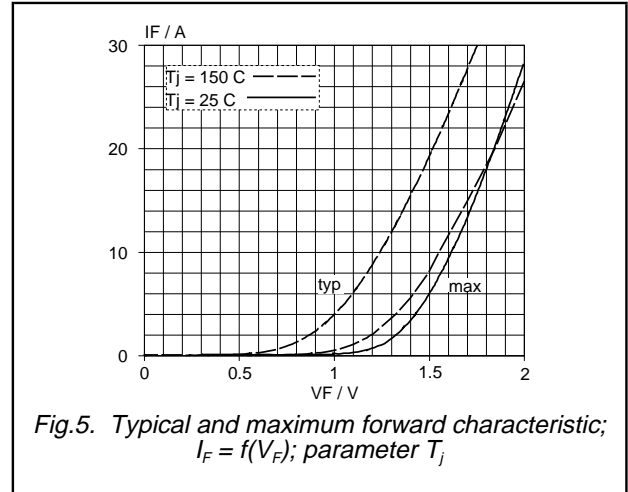
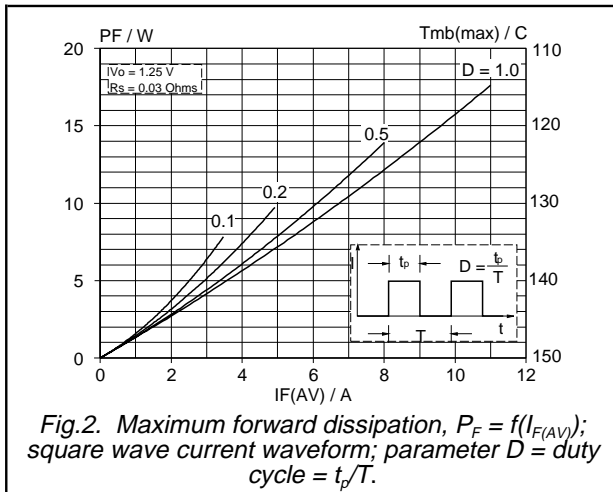
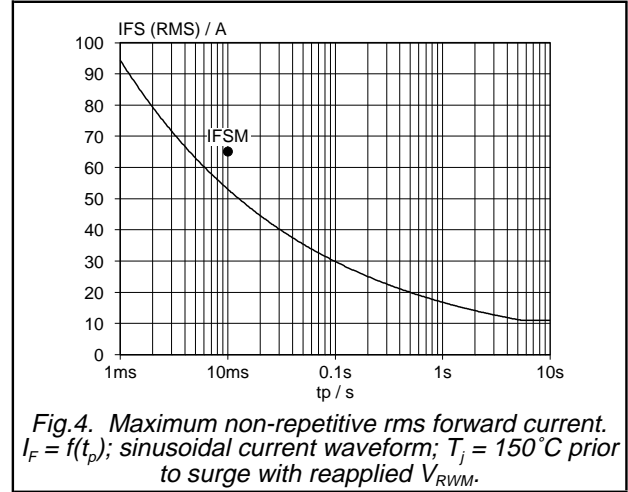
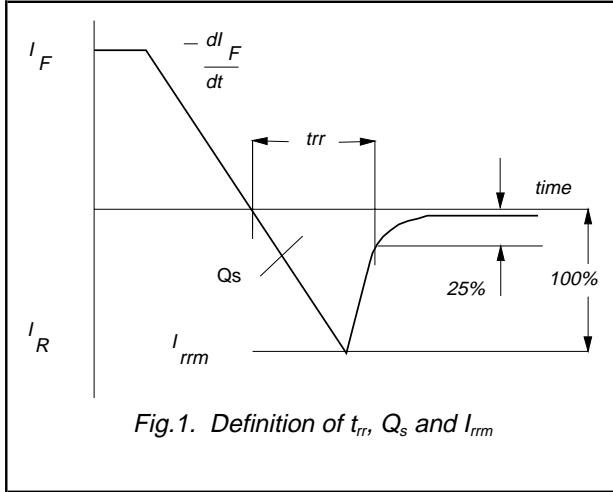

Rectifier diodes
fast, soft-recovery

BY329 series

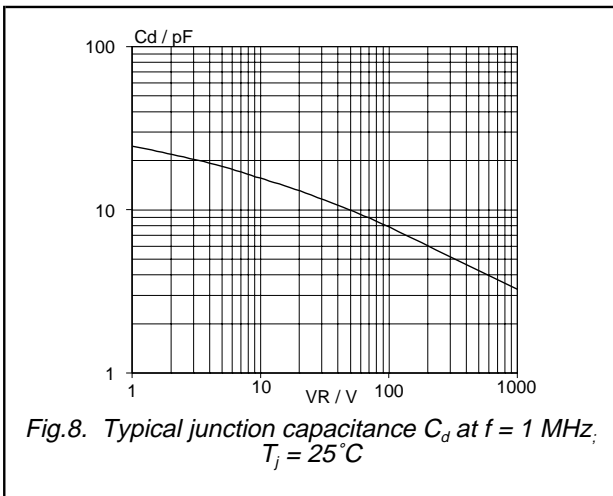
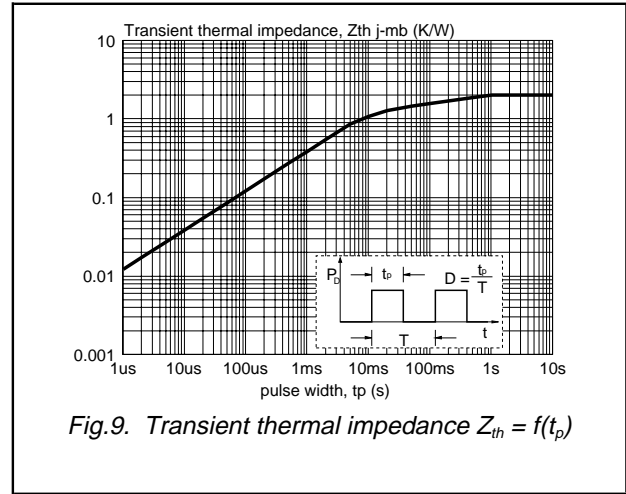
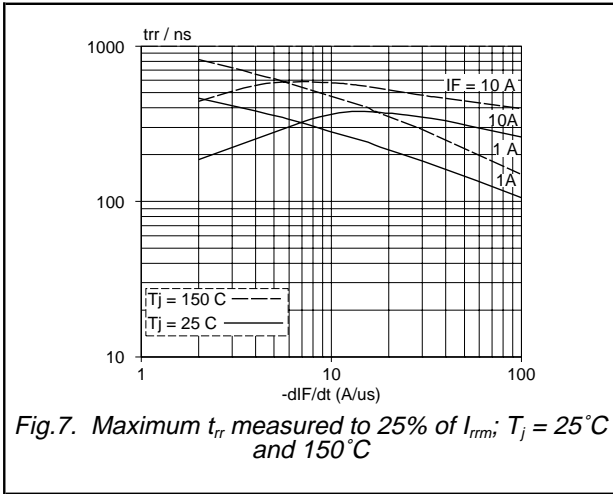

Rectifier diodes
fast, soft-recovery

BY329 series

MECHANICAL DATA

Dimensions in mm

Net Mass: 2 g

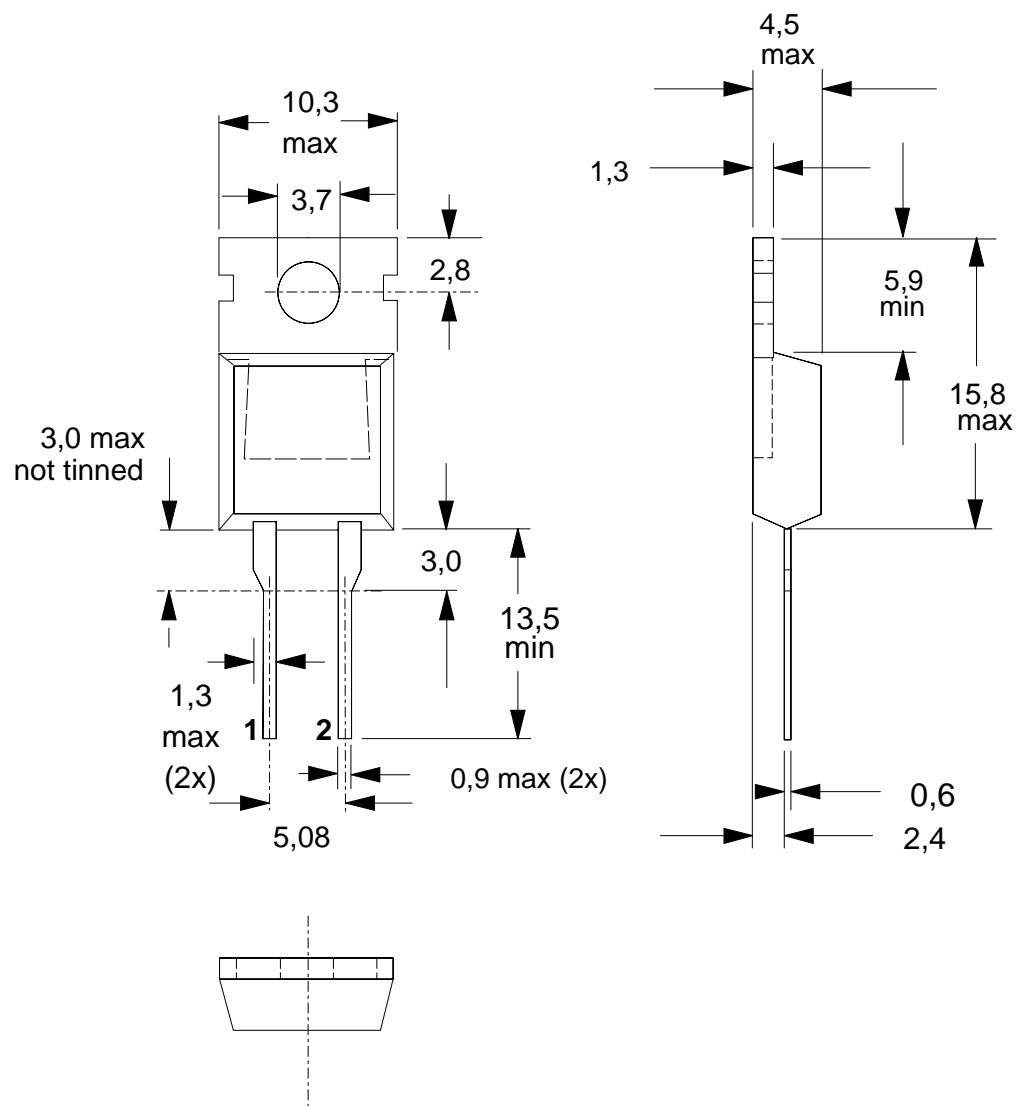

Fig.10. SOD59 (TO220AC). pin 1 connected to mounting base.

Notes

1. Refer to mounting instructions for TO220 envelopes.
2. Epoxy meets UL94 V0 at 1/8".

**Rectifier diodes
fast, soft-recovery**

BY329 series**DEFINITIONS**

Data sheet status	
Objective specification	This data sheet contains target or goal specifications for product development.
Preliminary specification	This data sheet contains preliminary data; supplementary data may be published later.
Product specification	This data sheet contains final product specifications.
Limiting values	
Limiting values are given in accordance with the Absolute Maximum Rating System (IEC 134). Stress above one or more of the limiting values may cause permanent damage to the device. These are stress ratings only and operation of the device at these or at any other conditions above those given in the Characteristics sections of this specification is not implied. Exposure to limiting values for extended periods may affect device reliability.	
Application information	
Where application information is given, it is advisory and does not form part of the specification.	
© Philips Electronics N.V. 1998	
All rights are reserved. Reproduction in whole or in part is prohibited without the prior written consent of the copyright owner.	
The information presented in this document does not form part of any quotation or contract, it is believed to be accurate and reliable and may be changed without notice. No liability will be accepted by the publisher for any consequence of its use. Publication thereof does not convey nor imply any license under patent or other industrial or intellectual property rights.	

LIFE SUPPORT APPLICATIONS

These products are not designed for use in life support appliances, devices or systems where malfunction of these products can be reasonably expected to result in personal injury. Philips customers using or selling these products for use in such applications do so at their own risk and agree to fully indemnify Philips for any damages resulting from such improper use or sale.