

27.0-34.0 GHz GaAs Receiver QFN, 4x4mm



December 2009 - Rev 11-Dec-09

X RI019-QH
X RoHS

Features

- X** Integrated LNA, Mixer and LO Buffer Amplifier
- X** 2.5 dB Noise Figure
- X** 13.0 dB Conversion Gain
- X** 4x4mm QFN Package
- X** 100% RF, DC and NF Testing



General Description

Mimix Broadband's 27.0-34.0 GHz QFN packaged receiver has a noise figure of 2.5 dB and 13.0 dB conversion gain. The device integrates an LNA, image reject mixer and LO buffer amplifier within a fully molded 4x4mm QFN package. The image reject mixer eliminates the need for a bandpass filter after the LNA to remove thermal noise at the image frequency. I and Q mixer outputs are provided and an external 90 degree hybrid is required to select the desired sideband. This device uses Mimix Broadband's GaAs pHEMT device model technology, and is based upon electron beam lithography to ensure high repeatability and uniformity. This device is well suited for Point-to-Point Radio, LMDS, SATCOM and VSAT applications.

Absolute Maximum Ratings¹

Supply Voltage (Vd1,2,3)	+4.3V
Supply Current (Id1,2,3)	200 mA
Gate Bias Voltage (Vg1,2,3)	-1.7V min., 0V max.
Gate Bias Voltage (Vg4)	-4 V
Input Power (RF)	+5 dBm
LO Power (LO)	+13 dBm
Storage Temperature (Tstg)	-65 to +150 °C
Operating Temperature (Ta)	-55 to +85 °C
Channel Temperature (Tch)	150 °C
ESD Min. Machine Model (MM)	Class A
ESD Min. Human Body Model (HBM)	Class 1A
Moisture Sensitivity Level	MSL3

(1) Operation of this device above any one of these parameters may cause permanent damage.
(2) Channel temperature directly affects a device's MTTF. Channel temperature should be kept as low as possible to maximize lifetime.

Electrical Characteristics (Ambient Temperature T = 25 °C)

Parameter	Units	Min.	Typ.	Max.
Frequency Range (RF)	GHz	27.0	-	34.0
Frequency Range (LO)	GHz	12.5	-	18.0
Frequency Range (IF)	GHz	DC	-	2.0
Conversion Gain (CG)	dB	-	13.0	-
Noise Figure (NF)	dB	-	2.5	-
Input Third Order Intercept (IIP3)	dBm	-	-2	-
Image Rejection	dBc	-	20.0	-
LO Input Drive	dBm	3.0	4.0	9.0
LO/RF Isolation	dB	-	-50.0	-
RF Input Return Loss	dB	-	10.0	-
LO Input Return Loss	dB	-	10.0	-
IF Return Loss	dB	-	12.0	-
Drain Bias Voltage (Vd1,2,3)	VDC	-	3.0	-
Gate Bias Voltage (Vg1,2,3)*	VDC	-	-0.35	-
Gate Bias Voltage (Vg4)**	VDC	-3.8	-3.0	-2.0
Supply Current (Id1)	mA	-	7.5	-
Supply Current (Id2)	mA	-	30	-
Supply Current (Id3)	mA	-	90	-
Supply Current (Ig4)	mA	-	10	-

*Vg1,2 and 3 are adjusted to achieve constant drain current regulation.

**Vg4 provides mixer bias and is fixed at -3.0V.

Mimix Broadband, Inc., 10795 Rockley Rd., Houston, Texas 77099
Tel: 281.988.4600 Fax: 281.988.4615 mimixbroadband.com

Page 1 of 8

Characteristic Data and Specifications are subject to change without notice. ©2009 Mimix Broadband, Inc.
Export of this item may require appropriate export licensing from the U.S. Government. In purchasing these parts, U.S. Domestic customers accept their obligation to be compliant with U.S. Export Laws.

27.0-34.0 GHz GaAs Receiver QFN, 4x4mm



December 2009 - Rev 11-Dec-09

XR1019-QH
RoHS

Receiver Measurements

XR1019-QH: LSB Conv. Gain vs. Freq (GHz), Over Temp
Vd1,2,3=3 V;Id1=7.5mA,Id2=30mA,Id3=90mA,Vg4=-3V

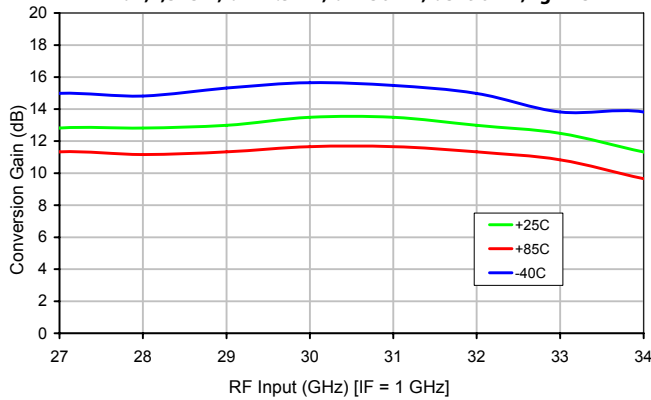

XR1019-QH: USB Conv. Gain vs. Freq (GHz), Over Temp
Vd1,2,3=3 V;Id1=7.5mA,Id2=30mA,Id3=90mA,Vg4=-3V

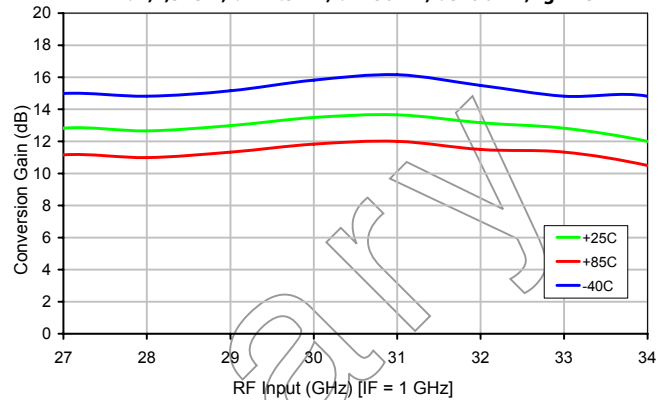

XR1019-QH: LSB Noise Figure vs. Freq (GHz), Over Temp
Vd1,2,3=3 V;Id1=7.5mA,Id2=30mA,Id3=90mA,Vg4=-3V

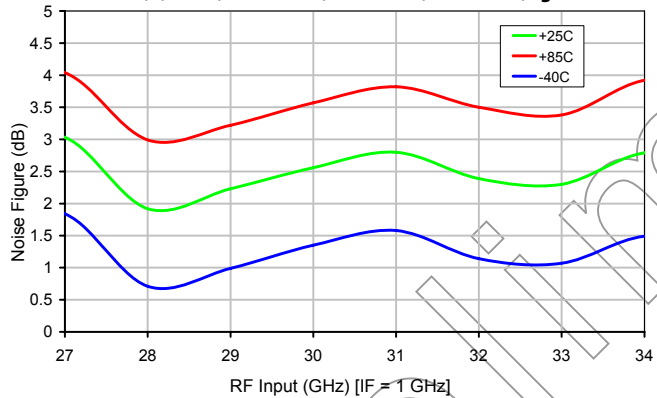

XR1019-QH: USB Noise Figure vs. Freq (GHz), Over Temp
Vd1,2,3=3 V;Id1=7.5mA,Id2=30mA,Id3=90mA,Vg4=-3V

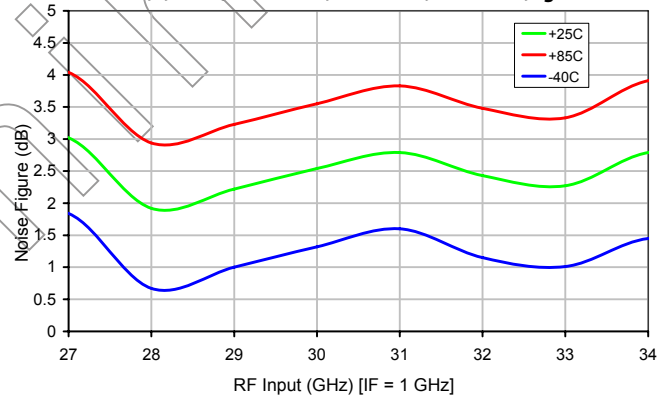

XR1019-QH: LSB IIP3 vs. Freq (GHz), Over Temp
Vd1,2,3=3 V;Id1=7.5mA,Id2=30mA,Id3=90mA,Vg4=-3V

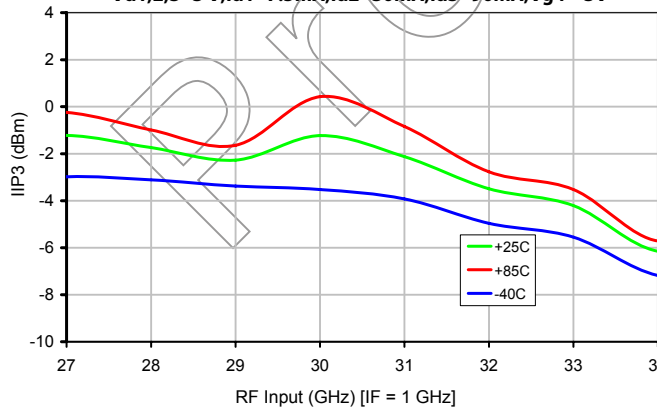

XR1019-QH: USB IIP3 vs. Freq (GHz), Over Temp
Vd1,2,3=3 V;Id1=7.5mA,Id2=30mA,Id3=90mA,Vg4=-3V

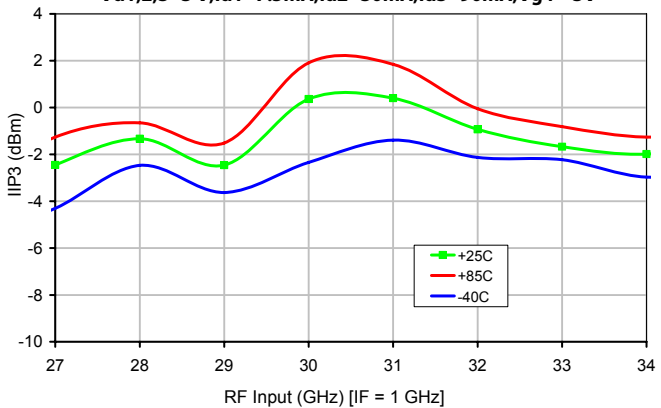

27.0-34.0 GHz GaAs Receiver QFN, 4x4mm

December 2009 - Rev 11-Dec-09

Receiver Measurements (cont.)

XR1019-QH: LSB Image Rejection vs. Freq (GHz), Over Temp
Vd1,2,3=3 V; Id1=7.5mA, Id2=30mA, Id3=90mA, Vg4=-3V

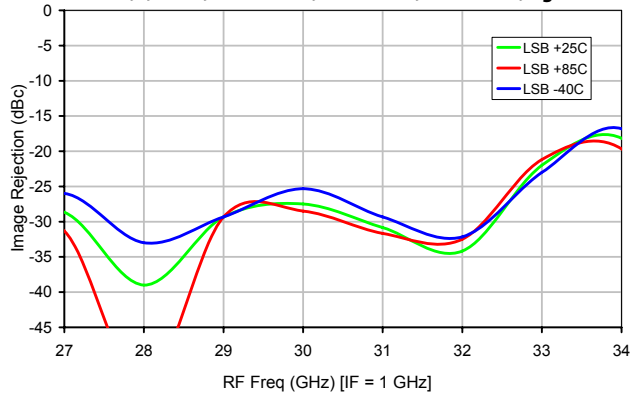

XR1019-QH: USB Image Rejection vs. Freq (GHz), Over Temp
Vd1,2,3=3 V; Id1=7.5mA, Id2=30mA, Id3=90mA, Vg4=-3V

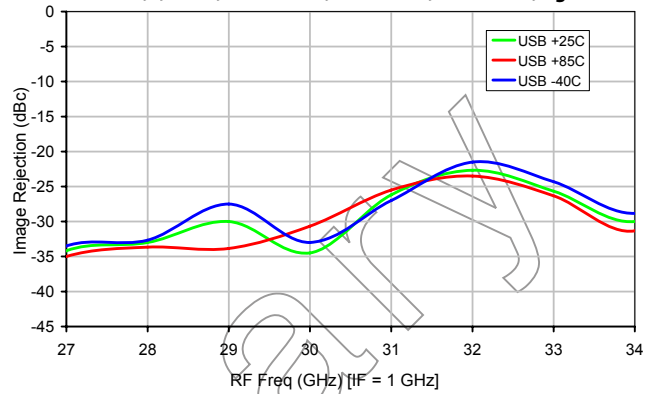

XR1019-QH: Conv. Gain vs IF Freq (GHz)
Vd1,2,3=3 V; Id1=7.5mA, Id2=30mA, Id3=90mA, Vg4=-3V

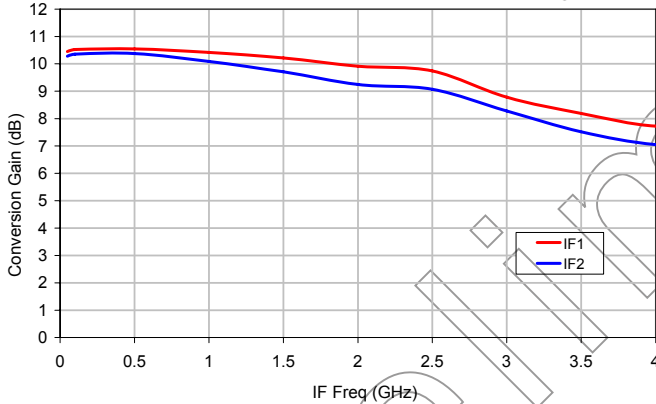

XR1019-QH: RF and LO Return Loss vs. Freq (GHz)
Vd1,2,3=3 V; Id1=7.5mA, Id2=30mA, Id3=90mA, Vg4=-3V

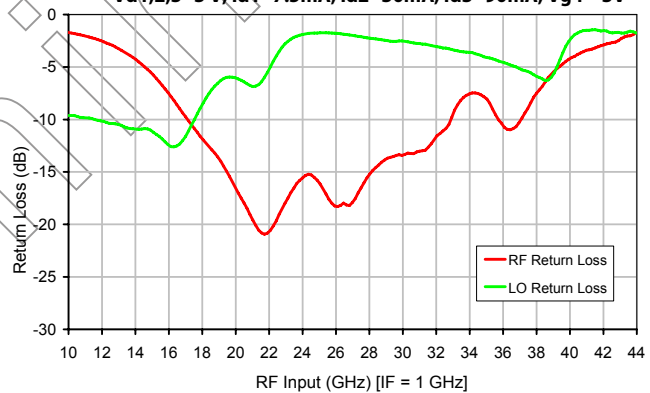

XR1019-QH: USB Conv. Gain vs Freq (GHz), Varying LO Power
Vd1,2,3=3 V; Id1=7.5mA, Id2=30mA, Id3=90mA, Vg4=-3V

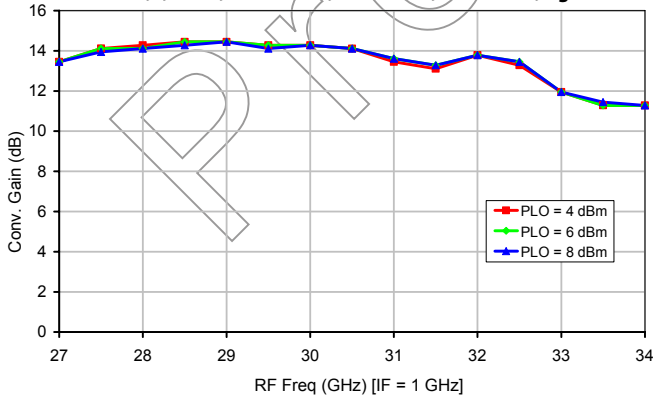

XR1019-QH: USB IIP3 vs Freq (GHz), Varying LO Power
Vd1,2,3=3 V; Id1=7.5mA, Id2=30mA, Id3=90mA, Vg4=-3V

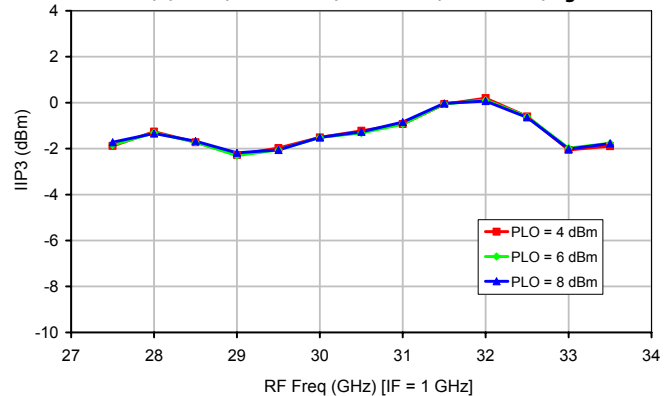

27.0-34.0 GHz GaAs Receiver QFN, 4x4mm

December 2009 - Rev 11-Dec-09

Mimix
BROADBAND™

✕ R1019-QH
✕ RoHS

Receiver Measurements (cont.)

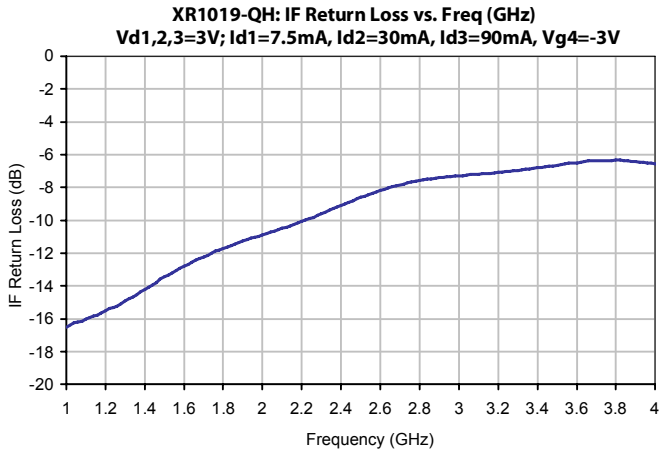

Preliminary

27.0-34.0 GHz GaAs Receiver QFN, 4x4mm

December 2009 - Rev 11-Dec-09

Mimix
BROADBAND™

XR1019-QH
RoHS

MTTF

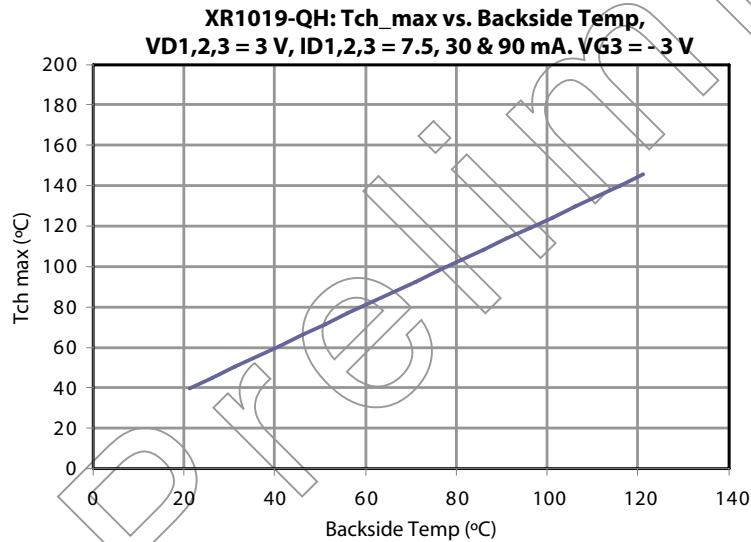
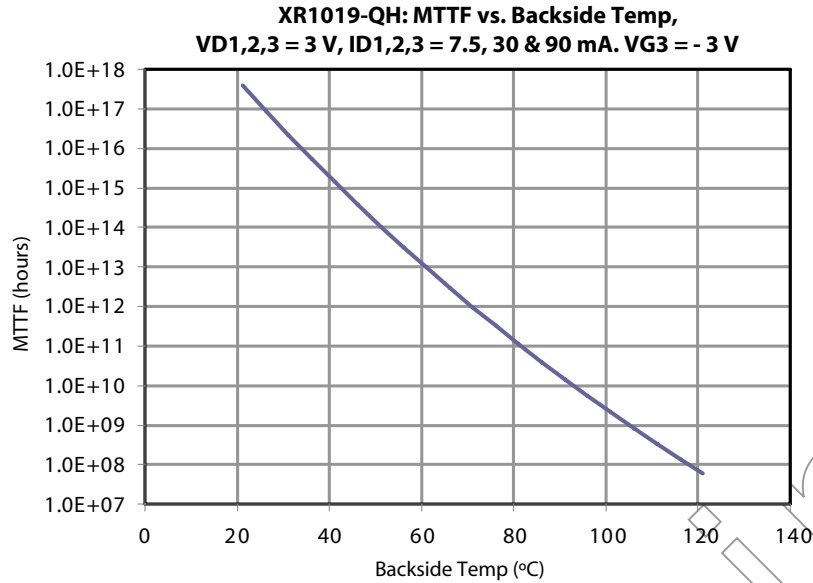

MTTF is calculated from accelerated life-time data of single devices and assumes an isothermal back-plate.

27.0-34.0 GHz GaAs Receiver QFN, 4x4mm

December 2009 - Rev 11-Dec-09

Package Dimensions / Layout

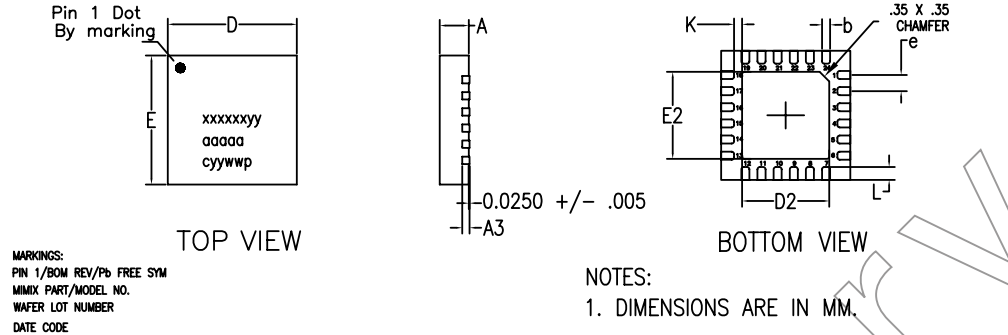

RECOMMENDED SOLDER PAD PITCH AND DIMENSIONS

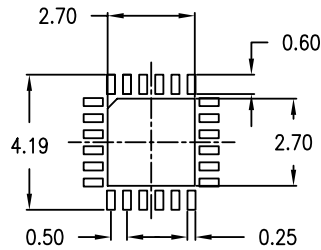

1. VIEWS ARE NOT TO SCALE: USE DIMENSIONS AND TABLE.

	MIN	TYP	MAX
A	0.80	0.90	1.00
A3		0.20 REF	
b	0.20	0.25	0.30
K	0.20	-	-
D		4.00 BSC	
E		4.00 BSC	
e		0.50	
D2	2.45	2.60	2.75
E2	2.45	2.60	2.75
L	0.20	0.30	0.40

Functional Block Diagram

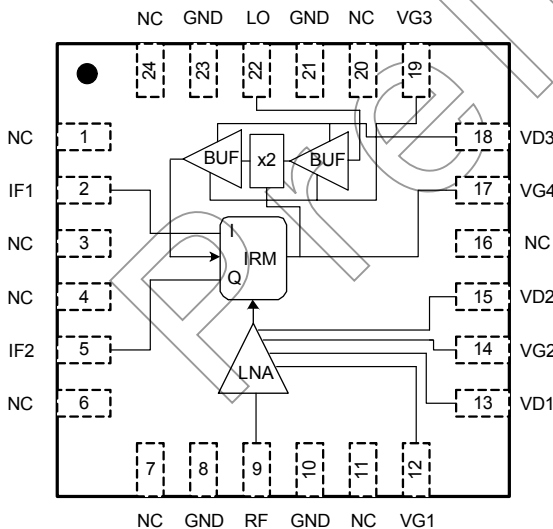

Pin Designations

Pin Number	Pin Name	Pin Function	Nominal Value
2	IF1	IF1 output	To Hybrid 0° (USB) To Hybrid 90° (LSB) (1.4Ω)
5	IF2	IF2 output	To Hybrid 90° (USB) To Hybrid 0° (LSB) (1.4Ω)
8	GND	Ground	
9	RF IN	RF input	(1Ω)
10	GND	Ground	
12	VG1	Gate, LNA Stage 1	-0.35V (1.2MΩ)
13	VD1	Drain, LNA Stage 1	3V, 7.5mA (145Ω)
14	VG2	Gate, LNA Stage 2	-0.35V (1.2MΩ)
15	VD2	Drain, LNA Stage 2	3V, 30mA (17Ω)
17	VG4	Mixer Bias	-3V, 10mA (295Ω)
18	VD3	Drain, LO Buffer	3V, 90mA (4.3Ω)
19	VG3	Gate, LO Buffer	-0.35V (1.1MΩ)
21	GND	Ground	
22	LO IN	LO input	(1.4Ω)
23	GND	Ground	
1,3,4,6,7,11,16,20,24	NC	Not Connected	

27.0-34.0 GHz GaAs Receiver QFN, 4x4mm

December 2009 - Rev 1 | Dec-09

App Note [1] Biasing - As shown in the Pin Designations table, the device is operated by biasing VD1,2,3 at 3.0V with 7.5, 30, 90mA respectively. Additionally, a fixed voltage bias of -3V is required for mixer bias. It is recommended to use active bias to keep the currents constant in order to maintain the best performance over temperature. Depending on the supply voltage available and the power dissipation constraints, the bias circuit may be a single transistor or a low power operational amplifier, with a low value resistor in series with the drain supply used to sense the current. The gate of the pHEMT is controlled to maintain correct drain current and thus drain voltage. The typical gate voltage needed to do this is -0.35V. Make sure to sequence the applied voltage to ensure negative gate bias is available before applying the positive drain supply.

App Note [2] Board Layout - As shown in the board layout, it is recommended to provide 100pF decoupling caps as close to the bias pins as possible, with additional 10µF decoupling caps.

Recommended Board Layout

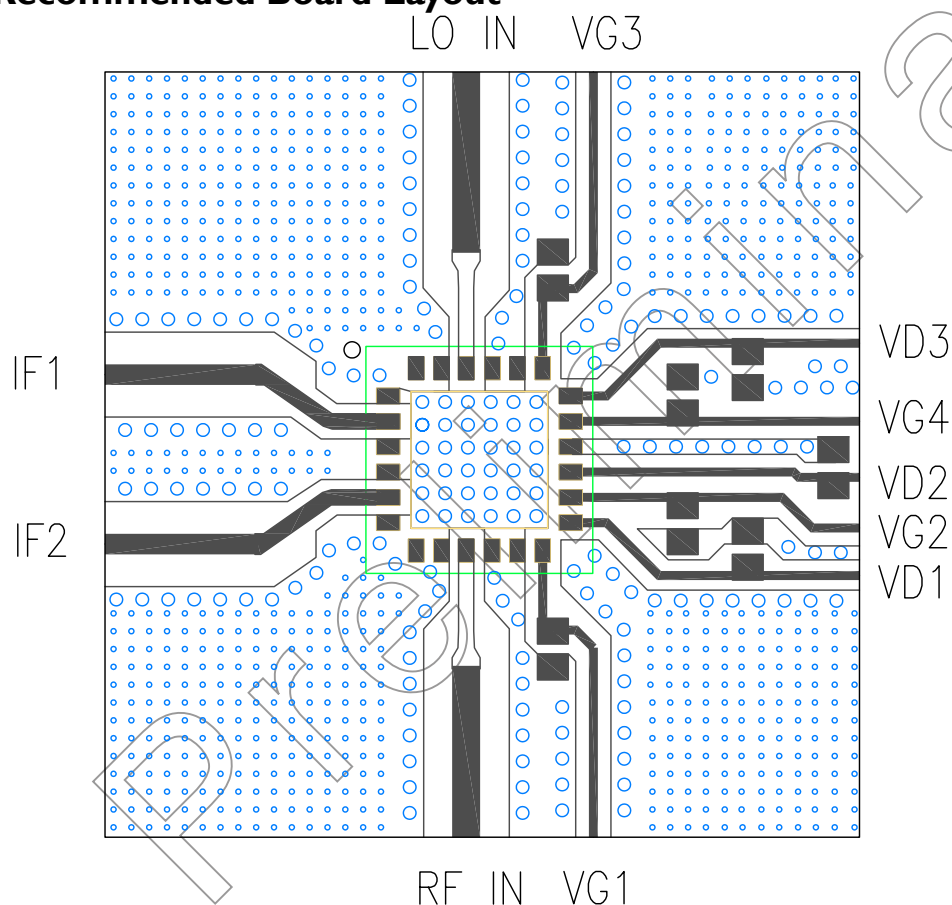

Recommended Decoupling Capacitors: 100pF 0402
10µF 0805

Recommend to externally ground all NC pins

27.0-34.0 GHz GaAs Receiver QFN, 4x4mm

Mimix
BROADBAND™

December 2009 - Rev 11-Dec-09

XR1019-QH
RoHS

Handling and Assembly Information

CAUTION! - Mimix Broadband MMIC Products contain gallium arsenide (GaAs) which can be hazardous to the human body and the environment. For safety, observe the following procedures:

- Do not ingest.
- Do not alter the form of this product into a gas, powder, or liquid through burning, crushing, or chemical processing as these by-products are dangerous to the human body if inhaled, ingested, or swallowed.
- Observe government laws and company regulations when discarding this product. This product must be discarded in accordance with methods specified by applicable hazardous waste procedures.

Electrostatic Sensitive Device -

Observe all necessary precautions when handling.

Life Support Policy - Mimix Broadband's products are not authorized for use as critical components in life support devices or systems without the express written approval of the President and General Counsel of Mimix Broadband. As used herein: (1) Life support devices or systems are devices or systems which, (a) are intended for surgical implant into the body, or (b) support or sustain life, and whose failure to perform when properly used in accordance with instructions for use provided in the labeling, can be reasonably expected to result in a significant injury to the user. (2) A critical component is any component of a life support device or system whose failure to perform can be reasonably expected to cause the failure of the life support device or system, or to affect its safety or effectiveness.

Package Attachment - This packaged product from Mimix Broadband is provided as a rugged surface mount package compatible with high volume solder installation. Vacuum tools or other suitable pick and place equipment may be used to pick and place this part. Care should be taken to ensure that there are no voids or gaps in the solder connection so that good RF, DC and ground connections are maintained. Voids or gaps can eventually lead not only to RF performance degradation, but reduced reliability and life of the product due to thermal stress.

Typical Reflow Profiles

Reflow Profile	SnPb	Pb Free
Ramp Up Rate	3-4 °C/sec	3-4 °C/sec
Activation Time and Temperature	60-120 sec @ 140-160 °C	60-180 sec @ 170-200 °C
Time Above Melting Point	60-150 sec	60-150 sec
Max Peak Temperature	240 °C	265 °C
Time Within 5 °C of Peak	10-20 sec	10-20 sec
Ramp Down Rate	4-6 °C/sec	4-6 °C/sec

Mimix Lead-Free RoHS Compliant Program - Mimix has an active program in place to meet customer and governmental requirements for eliminating lead (Pb) and other environmentally hazardous materials from our products. All Mimix RoHS compliant components are form, fit and functional replacements for their non-RoHS equivalents. Lead plating of our RoHS compliant parts is 100% matte tin (Sn) over copper alloy and is backwards compatible with current standard SnPb low-temperature reflow processes as well as higher temperature (260°C reflow) "Pb Free" processes.

Part Number for Ordering

XR1019-QH-0GPO
XR1019-QH-0GPT
XR1019-QH-EV1

Description

Matte Tin plated RoHS compliant 4x4 24L QFN surface mount package in bulk quantity
Matte Tin plated RoHS compliant 4x4 24L QFN surface mount package in tape and reel
XR1019-QH evaluation board



Caution: ESD Sensitive
Appropriate precautions in handling, packaging
and testing devices must be observed.

Proper ESD procedures should be followed when handling this device.

Mimix Broadband, Inc., 10795 Rockley Rd., Houston, Texas 77099
Tel: 281.988.4600 Fax: 281.988.4615 mimixbroadband.com

Page 8 of 8

Characteristic Data and Specifications are subject to change without notice. ©2009 Mimix Broadband, Inc.
Export of this item may require appropriate export licensing from the U.S. Government. In purchasing these parts, U.S. Domestic customers accept their obligation to be compliant with U.S. Export Laws.