

Triple Balanced Mixers B22A 2.0 to 8.0 GHz

Specifications

RF Frequency	2.0 to 8.0 GHz
LO Frequency	2.0 to 8.0 GHz
LO Power	+13 dBm typ

Transfer Characteristics

Conversion Loss	6.2 dB typ 8.5 dB max
IF Frequency	2.0 to 6.0 GHz
LO to RF Isolation	16 dB min 24 dB typ
LO to IF Isolation	16 dB min 28 dB typ
IP3 In	+17 dBm typ
P1dB In	+7 dBm typ



Available Package Styles

Available Package Styles

W1,X,Y

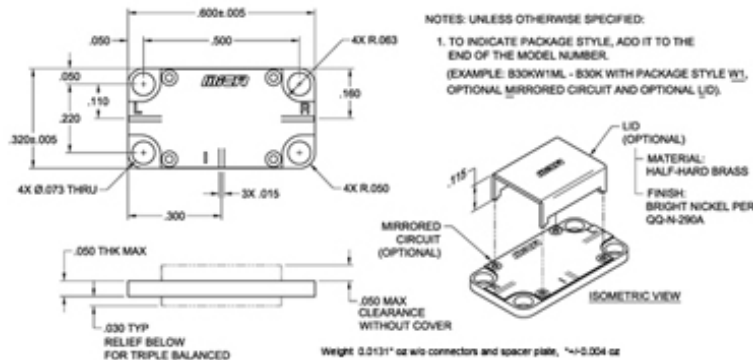

X PACKAGE

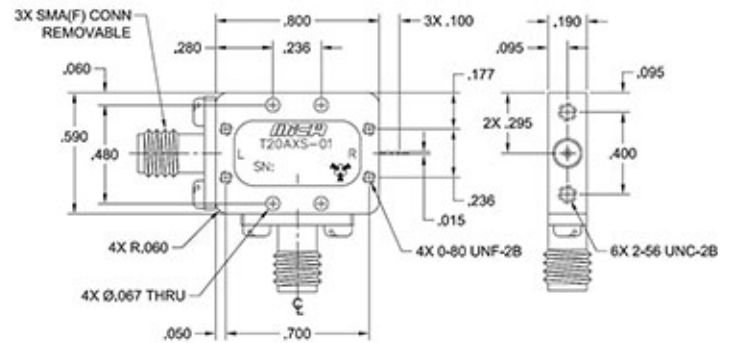

Environmental Ratings

Operating Temp -55 °C to 100 °C

Notes

Specifications subject to change without notice

Mica Microwave | Manteca, CA | 1-209-825-3977 | www.Mica-MW.com

