



American Opto Plus LED

C/A5581X G/W

2.3" 5 x 8 DOT MATRIX DISPLAY

- ❖ 2.3 inch (58.4 mm) height
- ❖ Low power consumption
- ❖ RoHS Compliance
- ❖ Case mold type

Package Dimensions

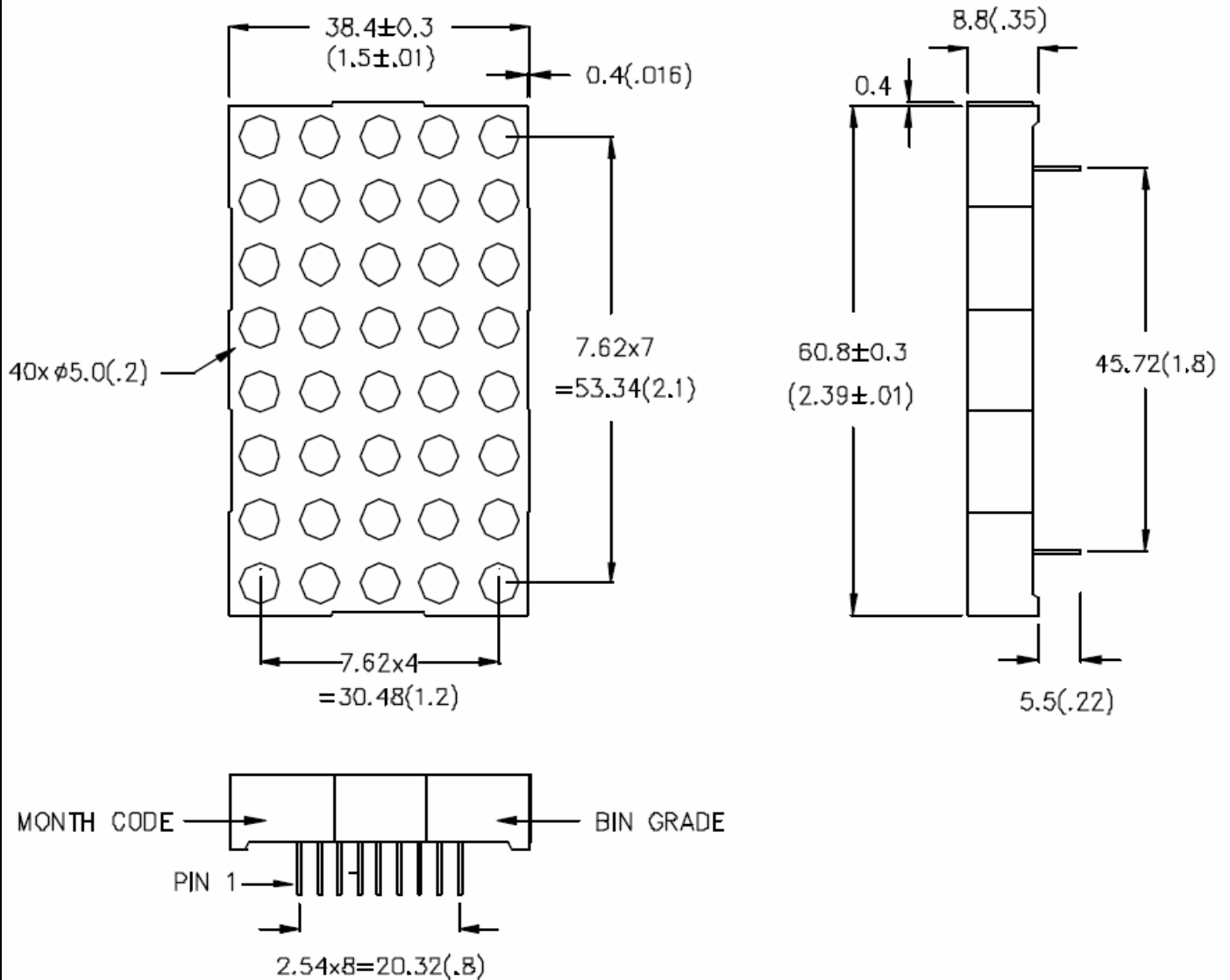

Notes: 1. All dimensions are in millimeters (inches)

2. Tolerance is ± 0.25 mm (0.01 ") unless otherwise specified



American Opto Plus LED

C/A5581X G/W

2.3" 5 x 8 DOT MATRIX DISPLAY

- ❖ 2.3 inch (58.4 mm) height
- ❖ Low power consumption
- ❖ RoHS Compliance
- ❖ Case mold type

Internal Circuit Diagram

**A5581 SERIES DIAGRAM
(COLUMN ANODE)**

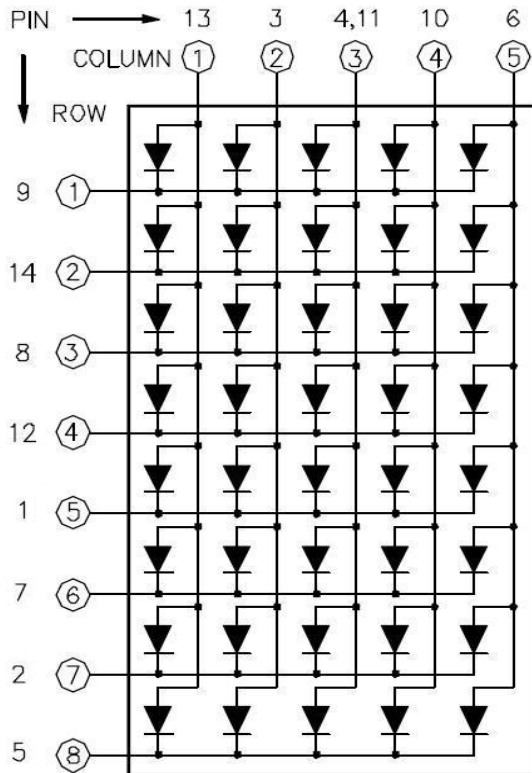

**C5581 SERIES DIAGRAM
(COLUMN CATHODE)**

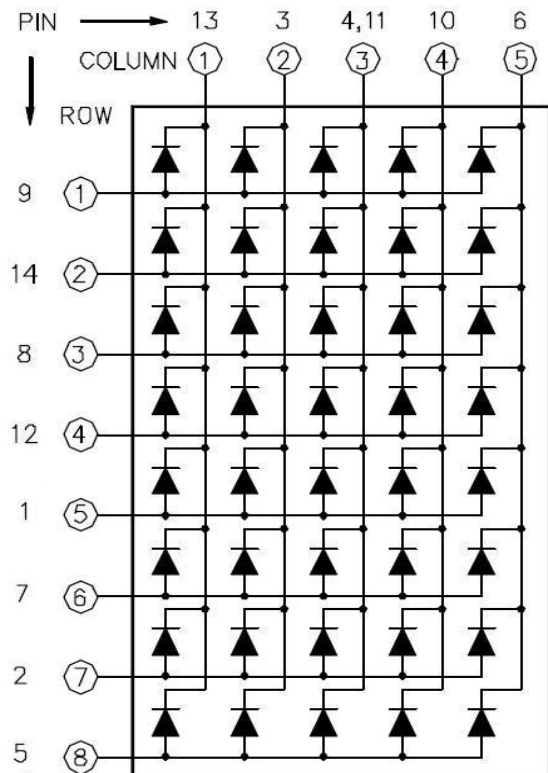



American Opto Plus LED

C/A5581X G/W

2.3'' 5 x 8 DOT MATRIX DISPLAY

- ❖ 2.3 inch (58.4 mm) height
- ❖ Low power consumption
- ❖ RoHS Compliance
- ❖ Case mold type

◆SELECTION GUIDE AND APPLICATION INFORMATION (RATINGS AT 25°C AMBIENT)

Part No.	Chip		Wave Length λ_p (nm)	Absolute Maximum Ratings				Electro-Optical Characteristics					
	Raw Material	Emitted Color		$\Delta\lambda$	Pad	I _{af}	I _{pf}	V _f (V)			I _f	I _v (μ cd)	
				nm	mW	mA	(Peak)	Min.	Typ.	Max.	(Rec)	Min.	Typ.
C/A 5581E G/W	GaAsP	Orange-Red	625	45	75	30	100	1.7	1.85	2.5	10	4700	8000
C/A 5581G G/W	GaP	Green	568	30	65	30	100	1.7	2.1	2.8	10	5000	13000
C/A 5581SR G/W	GaAlAs	Super Red	640	20	72	20	100	1.6	1.75	2.4	20	8000	27000
C/A 5581Y G/W	GaAsP	Yellow	588	35	75	30	100	1.7	2.1	2.8	10	1900	6400

◆ABSOLUTE MAXIMUM RATING: (Ta=25°C)

Reverse Voltage	: 5 Volt
Reverse Current (V _r =5V)	: 100 μ A
Operating Temperature Range	: -40°C ~ +85°C
Storage Temperature Range	: -40°C ~ +85°C
Soldering Temperature	: 250 ~ 260 for 3 seconds.

Para meter Description	Symbol	Unit
Spectral Line half-width	λ	nm
Power dissipation	P _d	mW
Peak Forward Current (Duty 1/10, @KHz)	I _f (Peak)	mA
Recommended Operation Current	I _f (Rec)	mA
Average Luminous intensity (I _f =10mA	I _v	μ cd



American Opto Plus LED

C/A5581X G/W

2.3" 5 x 8 DOT MATRIX DISPLAY

- ❖ 2.3 inch (58.4 mm) height
- ❖ Low power consumption
- ❖ RoHS Compliance
- ❖ Case mold type

TYPICAL ELECTRO-OPTICAL CHARACTERISTIC CURVES – GREEN (G)

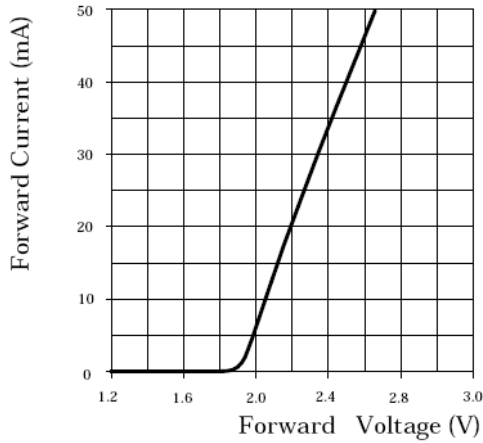

Forward Current Vs.
Forward Voltage

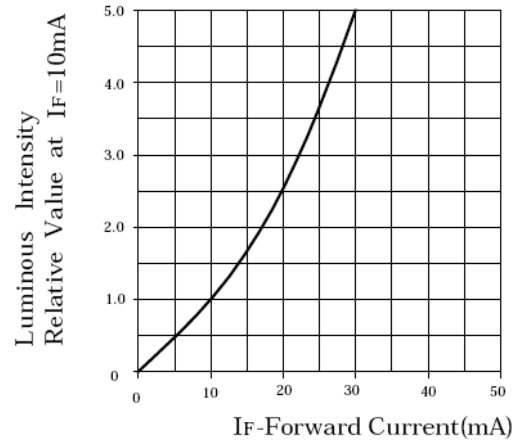

Luminous Intensity Vs.
Forward Current

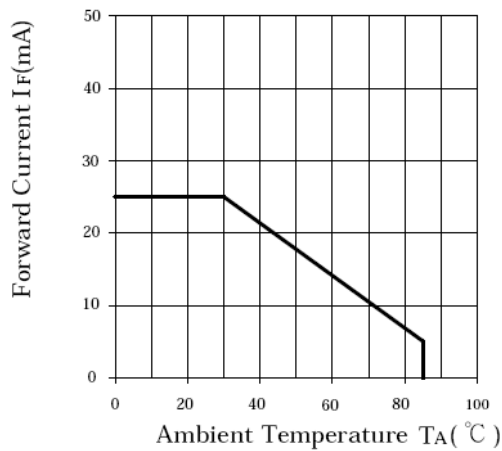

Forward Current
Derating Curve

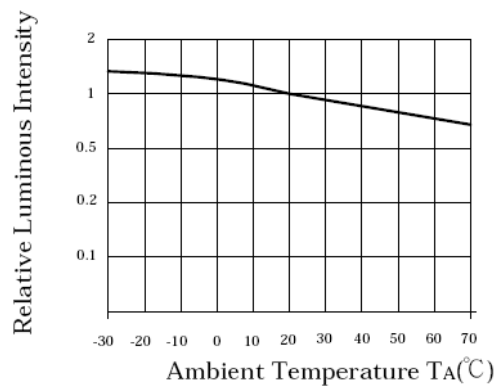

Luminous Intensity Vs.
Ambient Temperature



American Opto Plus LED

C/A5581X G/W

2.3" 5 x 8 DOT MATRIX DISPLAY

- ❖ 2.3 inch (58.4 mm) height
- ❖ Low power consumption
- ❖ RoHS Compliance
- ❖ Case mold type

TYPICAL ELECTRO-OPTICAL CHARACTERISTIC CURVES: ORANGE-RED (E)

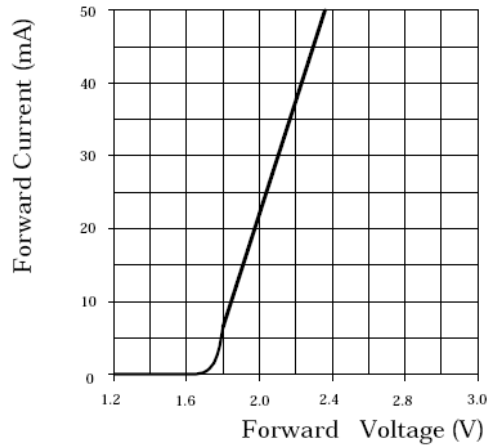

Forward Current Vs.
Forward Voltage

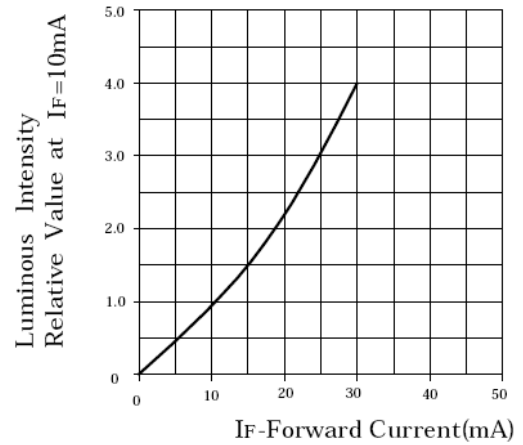

Luminous Intensity Vs.
Forward Current

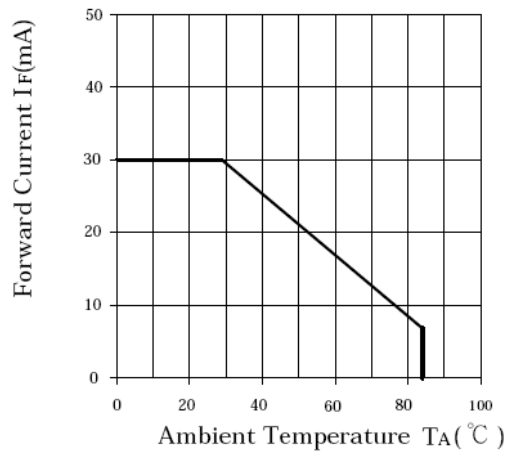

Forward Current
Derating Curve

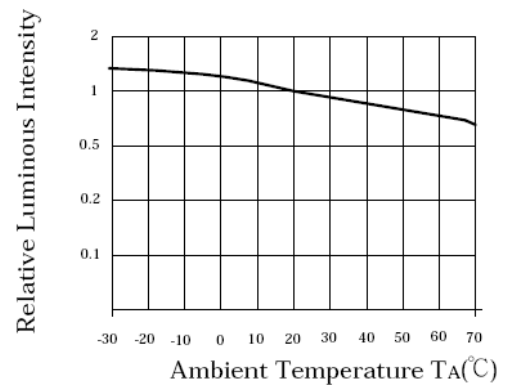

Luminous Intensity Vs.
Ambient Temperature



American Opto Plus LED

C/A5581X G/W

2.3" 5 x 8 DOT MATRIX DISPLAY

- ❖ 2.3 inch (58.4 mm) height
- ❖ Low power consumption
- ❖ RoHS Compliance
- ❖ Case mold type

TYPICAL ELECTRO-OPTICAL CHARACTERISTIC CURVES: SUPER RED (SR)

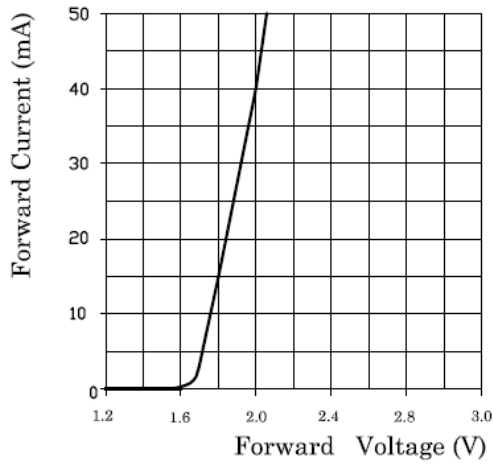

Forward Current Vs.
Forward Voltage

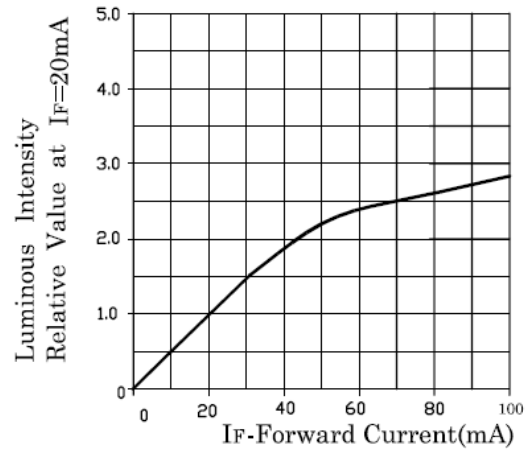

Luminous Intensity Vs.
Forward Current

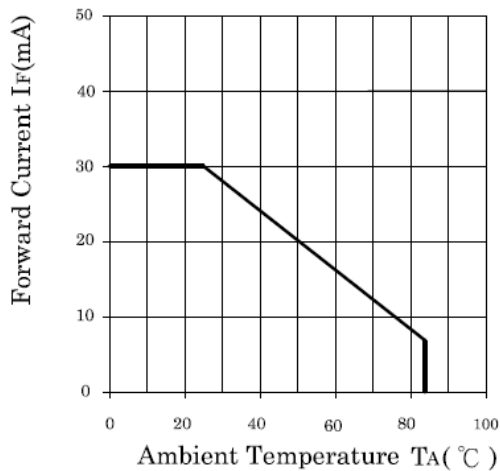

Forward Current
Derating Curve

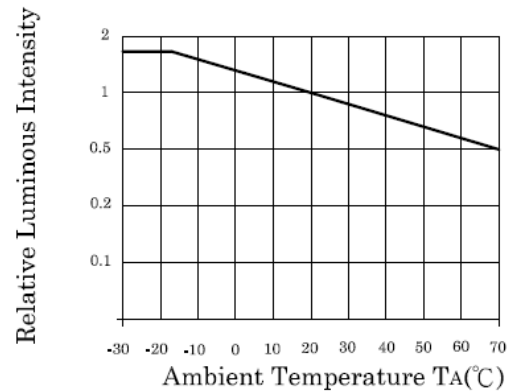

Luminous Intensity Vs.
Ambient Temperature



American Opto Plus LED

C/A5581X G/W

2.3" 5 x 8 DOT MATRIX DISPLAY

- ❖ 2.3 inch (58.4 mm) height
- ❖ Low power consumption
- ❖ RoHS Compliance
- ❖ Case mold type

TYPICAL ELECTRO-OPTICAL CHARACTERISTIC CURVES: YELLOW (Y)

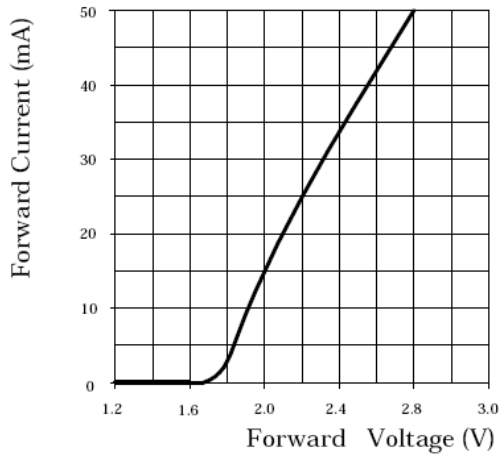

Forward Current Vs.
Forward Voltage

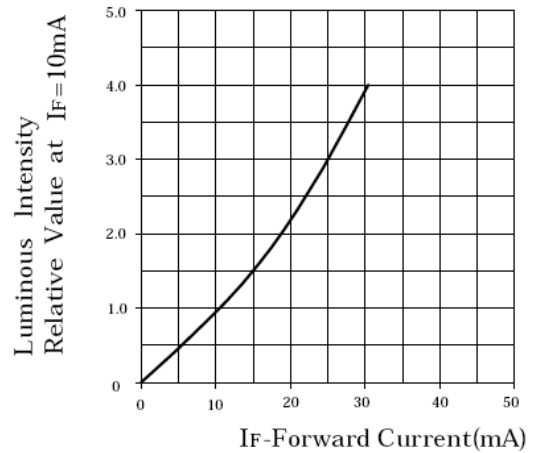

Luminous Intensity Vs.
Forward Current

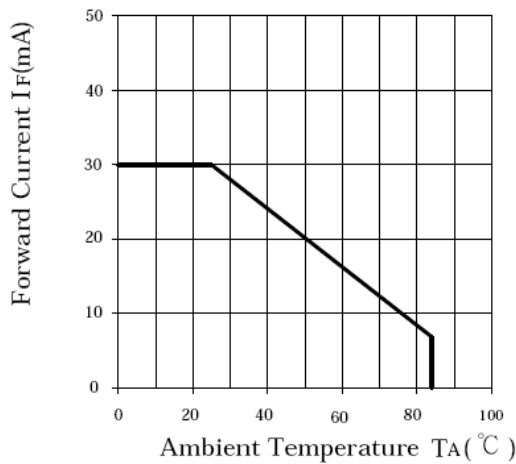

Forward Current
Derating Curve

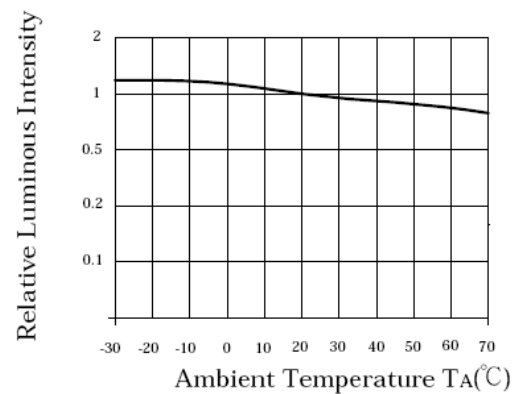

Luminous Intensity Vs.
Ambient Temperature



American Opto Plus LED
C/A5581X G/W
2.3'' 5 x 8 DOT MATRIX DISPLAY

- ❖ 2.3 inch (58.4 mm) height
- ❖ Low power consumption
- ❖ RoHS Compliance
- ❖ Case mold type

WAVE SOLDERING

SOLDERING INSTRUCTIONS						
TYPES	DIP AND WAVE SOLDERING			IRON SOLDERING(WITH 1.5mm IRON TIP)		
	TEMPERATURE OF THE SOLDERING BATH	MAXIMUM SOLDERING TIME	DISTANCE FROM SOLDER JOINT TO CASE	TEMPERATURE OF SOLDERING IRON	MAXIMUM SOLDERING TIME	DISTANCE FROM SOLDER JOINT TO CASE
LEDS	$\leq 260^{\circ}\text{C}$	3S	$>2\text{mm}$	$\leq 295^{\circ}\text{C}$	3S	$>2\text{mm}$
	$\leq 260^{\circ}\text{C}$	5S	$>4\text{mm}$	$\leq 295^{\circ}\text{C}$	5S	$>4\text{mm}$
DISPLAYS	$\leq 260^{\circ}\text{C}$	3S	$>2\text{mm}$	$\leq 295^{\circ}\text{C}$	3S	$>2\text{mm}$