

**Video Instrumentation Amplifiers**

***élan*tec**

The EL4430 and EL4431 are video instrumentation amplifiers which are ideal for line receivers, differential-to-

single-ended converters, transducer interfacing, and any situation where a differential signal must be extracted from a background of common-mode noise or DC offset.

These devices have two differential signal inputs and two differential feedback terminals. The FB terminal connects to the amplifier output, or a divided version of it to increase circuit gain, and the REF terminal is connected to the output ground or offset reference.

The EL4430 is compensated to be stable at a gain of 1 or more, and the EL4431 for a gain of 2 or more.

The amplifiers have an operational temperature of -40°C to +85°C and are packaged in plastic 8-pin DIP and SO-8.

The EL4430 and EL4431 are fabricated with Elantec's proprietary complementary bipolar process which gives excellent signal symmetry and is free from latchup.

**Pinout**

**EL4430, EL4431**  
**(8-PIN PDIP, SO)**  
TOP VIEW

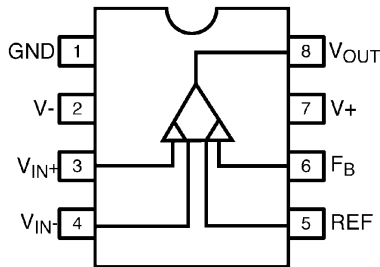

**Features**

- Fully differential inputs and feedback
- Differential input range of ±12V
- Common-mode range of ±12V
- High CMRR at 4MHz of 70dB
- Stable at gains of 1, 2
- Calibrated and clean input clipping
- EL4430—80MHz @ G = 1
- EL4431—160MHz GBWP
- 380V/μs slew rate
- 0.02% or ° differential gain or phase
- Operates on ±5 to ±15V supplies with no AC degradation

**Applications**

- Line receivers
- “Loop-through” interface
- Level translation
- Magnetic head pre-amplification
- Differential-to-single-ended conversion

**Ordering Information**

PART NUMBER	TEMP. RANGE	PACKAGE	PKG. NO.
EL4430CN	-40°C to +85°C	8-Pin PDIP	MDP0031
EL4430CS	-40°C to +85°C	8-Pin SO	MDP0027
EL4431CN	-40°C to +85°C	8-Pin PDIP	MDP0031
EL4431CS	-40°C to +85°C	8-Pin SO	MDP0027

## EL4430, EL4431

### Absolute Maximum Ratings ( $T_A = 25^\circ\text{C}$ )

<p>V+ Positive Supply Voltage . . . . . 16.5V</p> <p>V<sub>S</sub> V+ to V- Supply Voltage . . . . . 33V</p> <p>V<sub>IN</sub> Voltage at any Input or Feedback . . . . . V+ to V-</p> <p>V<sub>IN</sub> Difference between Pairs of Inputs or Feedback . . . . . 6V</p> <p>I<sub>IN</sub> Current into any Input, or Feedback Pin . . . . . 4mA</p>	<p>I<sub>OUT</sub> Continuous Output Current . . . . . 30mA</p> <p>P<sub>D</sub> Maximum Power Dissipation . . . . . See Curves</p> <p>T<sub>A</sub> Operating Temperature Range . . . . . -40°C to +85°C</p> <p>T<sub>S</sub> Storage Temperature Range . . . . . -60°C to +150°C</p>
--	--

*CAUTION: Stresses above those listed in "Absolute Maximum Ratings" may cause permanent damage to the device. This is a stress only rating and operation of the device at these or any other conditions above those indicated in the operational sections of this specification is not implied.*

*IMPORTANT NOTE: All parameters having Min/Max specifications are guaranteed. Typical values are for information purposes only. Unless otherwise noted, all tests are at the specified temperature and are pulsed tests, therefore:  $T_J = T_C = T_A$*

### Open-Loop DC Electrical Specifications

Power supplies at  $\pm 5\text{V}$ ,  $T_A = 25^\circ\text{C}$ . For the EL4431,  $R_F = R_G = 500\Omega$ .

PARAMETER	DESCRIPTION	MIN	TYP	MAX	UNITS	
V <sub>DIFF</sub>	Differential input voltage ( $V_{CM} = 0$ )	Clipping	2.0	2.3		V
		0.1% nonlinearity		1.8		V
V <sub>CM</sub>	Common-mode range ( $V_{DIFF} = 0$ )	V <sub>S</sub> = $\pm 5\text{V}$	$\pm 2$	$\pm 3.0$		V
		V <sub>S</sub> = $\pm 15\text{V}$	$\pm 12$	$\pm 13.0$		V
V <sub>OS</sub>	Input offset voltage		2	8		mV
I <sub>B</sub>	Input bias current (IN+, IN-, REF, and FB terminals)		12	20		$\mu\text{A}$
I <sub>OS</sub>	Input offset current between IN+ and IN- and between REF and FB		0.2	2		$\mu\text{A}$
R <sub>IN</sub>	Input resistance	100	230			k $\Omega$
CMRR	Common-mode rejection ratio	70	90			dB
PSRR	Power supply rejection ratio		60			dB
E <sub>G</sub>	Gain error, excluding feedback resistors	-1.5	-0.2	+0.5		%
V <sub>O</sub>	Output voltage swing EL4430	V <sub>S</sub> = $\pm 5\text{V}$	$\pm 2$	$\pm 2.8$		V
		V <sub>S</sub> = $\pm 15\text{V}$	$\pm 12$	$\pm 12.8$		V
	Output voltage swing EL4431	V <sub>S</sub> = $\pm 5\text{V}$	$\pm 2.5$	$\pm 3.0$		V
		V <sub>S</sub> = $\pm 15\text{V}$	$\pm 12.5$	$\pm 13.0$		V
I <sub>SC</sub>	Output short-circuit current	40	90			mA
I <sub>S</sub>	Supply current, V <sub>S</sub> = $\pm 15\text{V}$		13.5	16		mA

## EL4430, EL4431

### Closed-Loop AC Electrical Specifications

Power supplies at  $\pm 12V$ ,  $T_A = 25^\circ C$ ,  $R_L = 500\Omega$  for the EL4430,  $R_L = 150\Omega$  for the EL4431,  $C_L = 15pF$ . For the EL4431,  $R_F = R_G = 500\Omega$ .

PARAMETER	DESCRIPTION	MIN	TYP	MAX	UNITS
BW, -3dB	-3dB small-signal bandwidth	EL4430	82		MHz
		EL4431	80		MHz
BW, $\pm 0.1dB$	0.1dB flatness bandwidth	EL4430	20		MHz
		EL4431	14		MHz
Peaking	Frequency response peaking	EL4430	0.6		dB
		EL4431	1.0		dB
SR	Slew rate, $V_{OUT}$ between -2V and +2V		380		V/ $\mu s$
$V_N$	Input-referred noise voltage density		26		nV/ $\sqrt{Hz}$
dG	Differential gain error, Voffset between -0.7V and +0.7V	EL4430	0.02		%
		EL4431, $R_L = 150\Omega$	0.04		%
d $\theta$	Differential gain error, Voffset between -0.7V and +0.7V	EL4430	0.02		( $^\circ$ )
		EL4431, $R_L = 150\Omega$	0.08		( $^\circ$ )
$T_S$	Settling time, to 0.1% from a 4V step	EL4430	48		ns

### Test Circuit

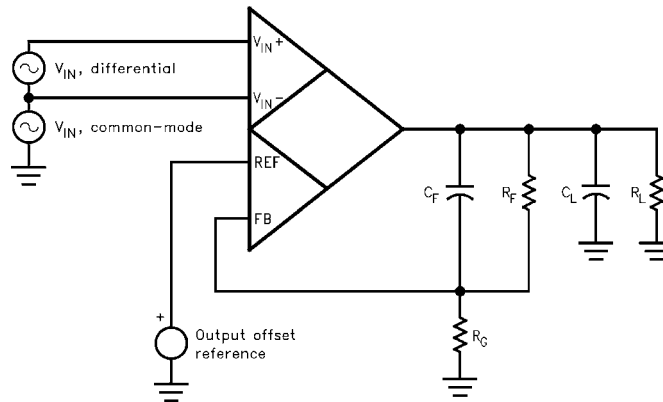

Typical Performance Curves

EL4430 and EL4431  
Common-Mode Rejection Ratio vs Frequency

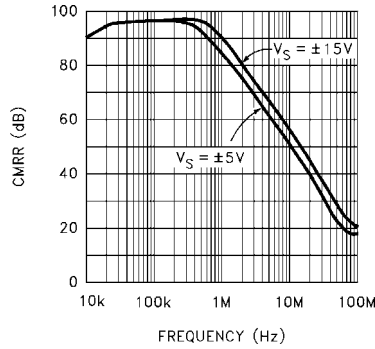

EL4430 Frequency Response vs Gain

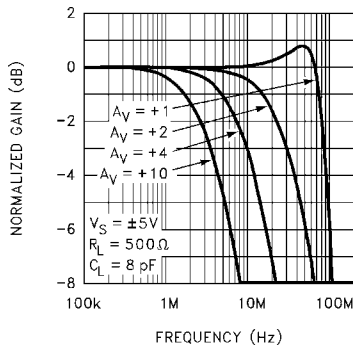

EL4430 Frequency Response for Various RL, CL VS = ±5V

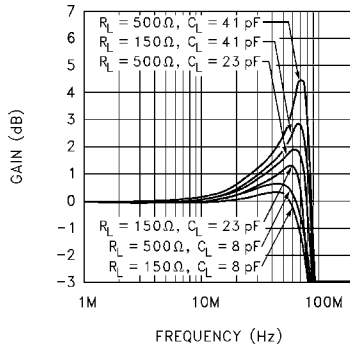

EL4430 Frequency Response for Various RL, CL VS = ±15V

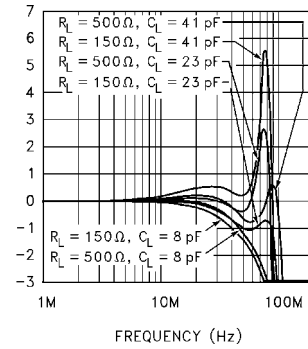

EL4431 Frequency Response vs Gain

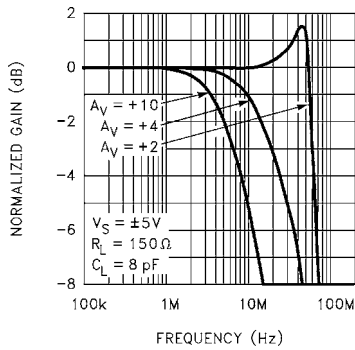

EL4431 Frequency Response for Various RL, CL VS = ±5V

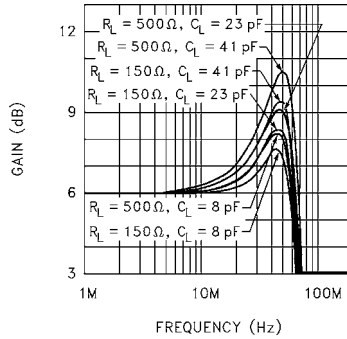

EL4431 Frequency Response for Various RL, CL VS = ±15V

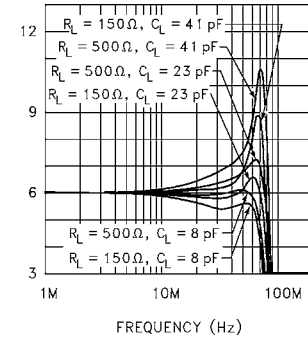

EL4430 Differential Gain and Phase vs Input Offset Voltage for VS = ±5V

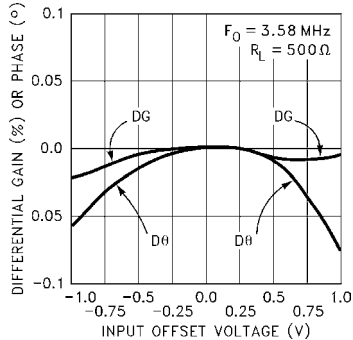

EL4430 Differential Gain and Phase vs Input Offset Voltage for VS = ±12V

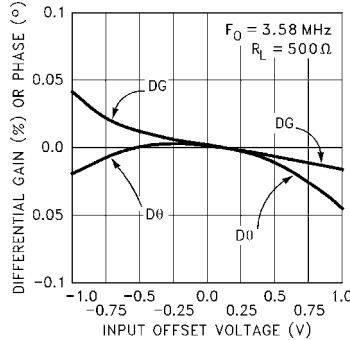

EL4430 Differential Gain and Phase Error vs RL

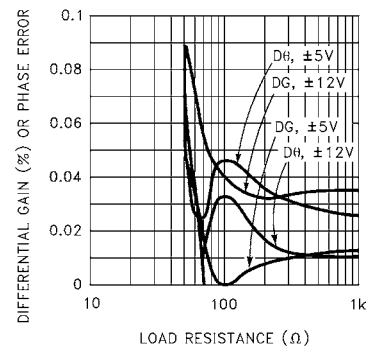

Typical Performance Curves (Continued)

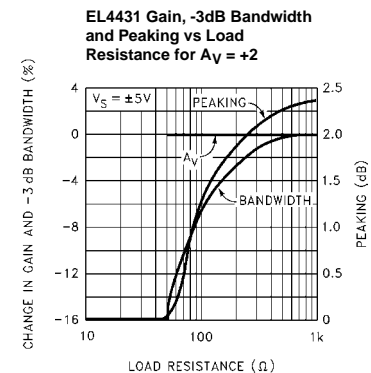
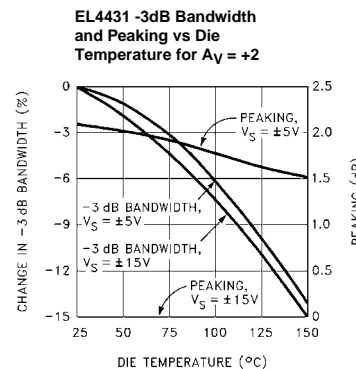
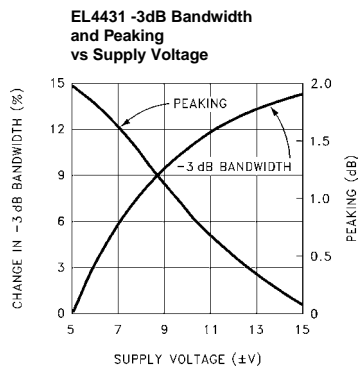
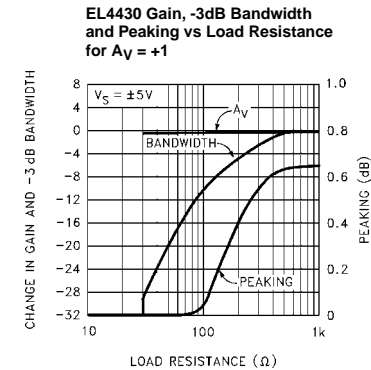
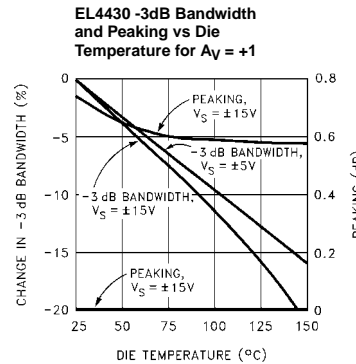
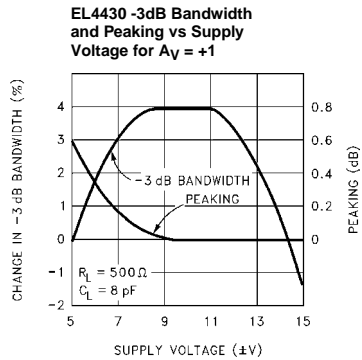
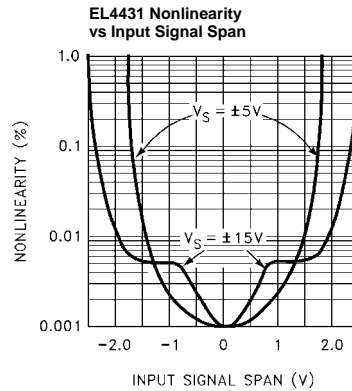
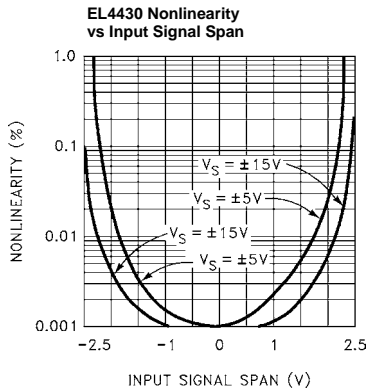
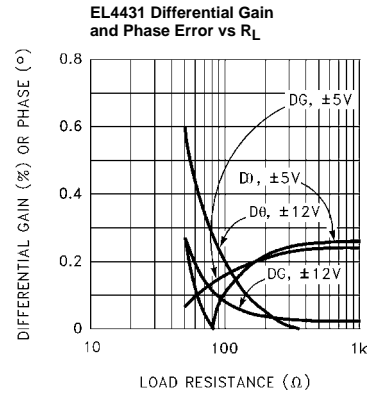
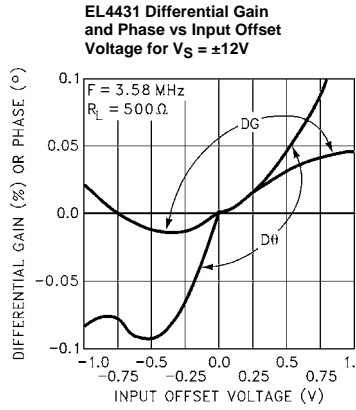
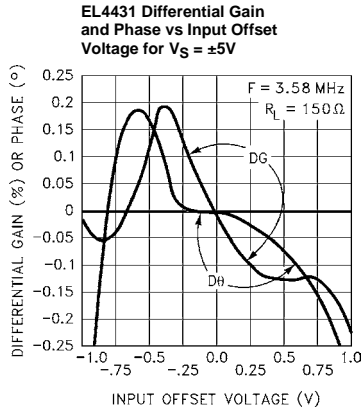

Typical Performance Curves (Continued)

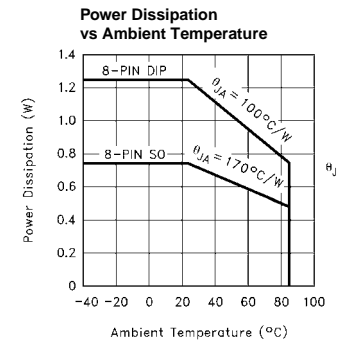
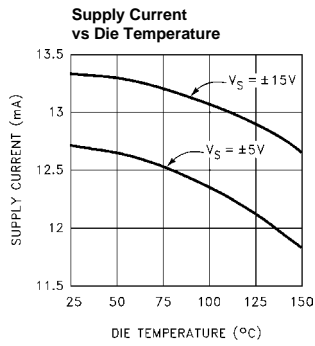
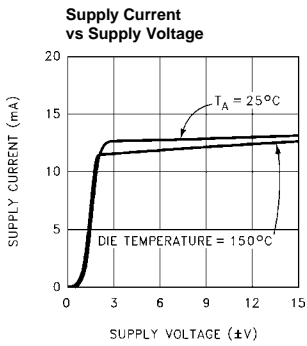
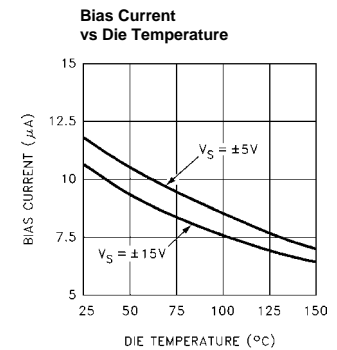
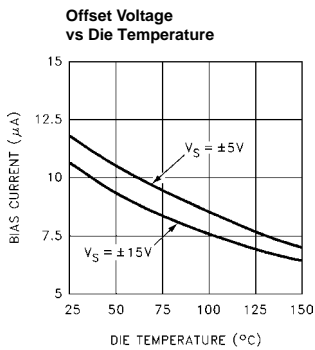
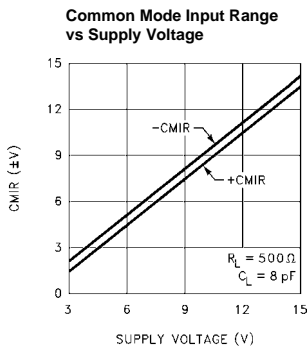
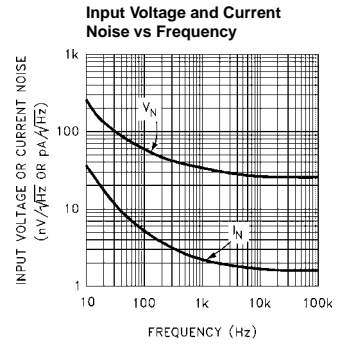
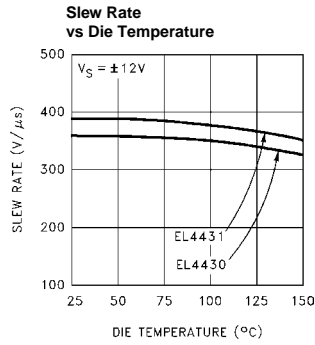
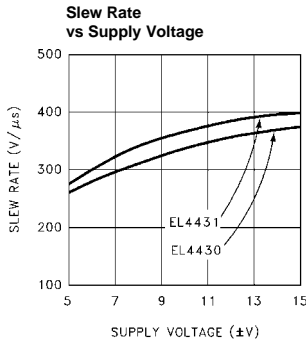

## Applications Information

The EL4430 and EL4431 are designed to convert a fully differential input to a single-ended output. It has two sets of inputs; one which is connected to the signal and does not respond to its common-mode level, and another which is used to complete a feedback loop with the output. Here is a typical connection:

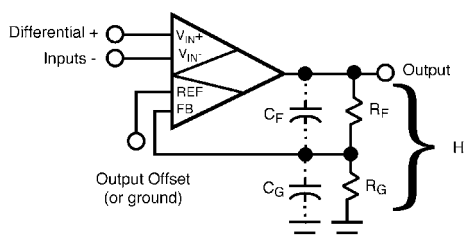

The gain of the feedback divider is  $H$ . The transfer function of the part is:

$$V_{OUT} = A_O \times ((V_{IN+}) - (V_{IN-}) + (V_{REF} - V_{FB})).$$

$V_{FB}$  is connected to  $V_{OUT}$  through a feedback network, so  $V_{FB} = H \times V_{OUT}$ .  $A_O$  is the open-loop gain of the amplifier, and is about 600 for the EL4430 and EL4431. The large value of  $A_O$  drives:

$$(V_{IN+}) - (V_{IN-}) + (V_{REF} - V_{FB}) \rightarrow 0.$$

Rearranging and substituting for  $V_{FB}$ :

$$V_{OUT} = ((V_{IN+}) - (V_{IN-}) + V_{REF})/H.$$

Thus, the output is equal to the difference of the  $V_{IN}$ s and offset by  $V_{REF}$  all gained up by the feedback divider ratio. The input impedance of the FB terminal (equal to  $R_{IN}$  of the input terminals) is in parallel with an  $R_G$ , and raises circuit gain slightly.

The EL4430 is stable for a gain of 1 (a direct connection between  $V_{OUT}$  and FB) or more and the EL4431 for gains of 2 or more. It is important to keep the feedback divider's impedance at the FB terminal low so that stray capacitance does not diminish the loop's phase margin. The pole caused by the parallel of resistors  $R_F$  and  $R_G$  and stray capacitance should be at least 200MHz; typical strays of 3pF thus require a feedback impedance of 270 $\Omega$  or less. Two 510 $\Omega$  resistors are acceptable for a gain of 2; 300 $\Omega$  and 2700 $\Omega$  make a good gain-of-10 divider. Alternatively, a small capacitor across  $R_F$  can be used to create more of a frequency-compensated divider. The value of the capacitor should scale with the parasitic capacitance at the FB terminal input. It is also practical to place small capacitors across both the feedback resistors (whose values maintain the desired gain) to swamp out parasitics. For instance, two 10pF capacitors (for a gain of 2) across equal divider resistors will dominate parasitic effects and allow a higher divider resistance.

## Input Connections

The input transistors can be driven from resistive and capacitive sources, but are capable of oscillation when presented with an inductive input. It takes about 80nH of series inductance to make the inputs actually oscillate, equivalent to 4 of unshielded wiring or about 6 of unterminated input transmission line. The oscillation has a characteristic frequency of 500MHz. Often, placing one's finger (via a metal probe) or an oscilloscope probe on the input will kill the oscillation. Normal high-frequency construction obviates any such problems, where the input source is reasonably close to the input. If this is not possible, one can insert series resistors of approximately 51 $\Omega$  to de-Q the inputs.

## Signal Amplitudes

Signal input common-mode voltage must be between (V-)+3V and (V+)-3V to ensure linearity. Additionally, the differential voltage on any input stage must be limited to  $\pm 6V$  to prevent damage. The differential signal range is  $\pm 2V$  in the EL4430 and EL4431. The input range is substantially constant with temperature.

## The Ground Pin

The ground pin draws only 6 $\mu A$  maximum DC current, and may be biased anywhere between (V-)+2.5V and (V+)-3.5V. The ground pin is connected to the IC's substrate and frequency compensation components. It serves as a shield within the IC and enhances CMRR over frequency, and if connected to a potential other than ground, it must be bypassed.

## Power Supplies

The instrumentation amplifiers work well on any supplies from  $\pm 3V$  to  $\pm 15V$ . The supplies may be of different voltages as long as the requirements of the Gnd pin are observed (see the Ground Pin section for a discussion). The supplies should be bypassed close to the device with short leads. 4.7 $\mu F$  tantalum capacitors are very good, and no smaller bypasses need be placed in parallel. Capacitors as low as 0.01 $\mu F$  can be used if small load currents flow.

Single-polarity supplies, such as +12V with +5V can be used, where the ground pin is connected to +5V and V- to ground. The inputs and outputs will have to have their levels shifted above ground to accommodate the lack of negative supply.

The dissipation of the amplifiers increases with power supply voltage, and this must be compatible with the package chosen. This is a close estimate for the dissipation of a circuit:

$$P_D = 2 \times V_S \times I_S, \max + (V_S - V_O) \times V_O / R_{PAR}$$

where

$I_S, \text{max}$  is the maximum supply current

$V_S$  is the  $\pm$  supply voltage (assumed equal)

$V_O$  is the output voltage

$R_{PAR}$  is the parallel of all resistors loading the output

For instance, the EL4431 draws a maximum of 16mA and we might require a 2V peak output into 150 $\Omega$  and a 270 $\Omega$  + 270 $\Omega$  feedback divider.

The  $R_{PAR}$  is 117 $\Omega$ . The dissipation with  $\pm 5V$  supplies is 201mW. The maximum supply voltage that the device can run on for a given  $P_D$  and the other parameter is:

$$V_S, \text{max} = (P_D + V_O^2/R_{PAR}) / (2I_S + V_O/R_{PAR})$$

The maximum dissipation a package can offer is:

$$P_D, \text{max} = (T_{J, \text{max}} - T_A, \text{max}) / \theta_{JA}$$

where

$T_{J, \text{max}}$  is the maximum die junction temperature, 150°C for reliability, less to retain optimum electrical performance.

$T_A, \text{max}$  is the ambient temperature, 70°C for commercial and 85°C for industrial range.

$\theta_{JA}$  is the thermal resistance of the mounted package, obtained from datasheet dissipation curves.

The more difficult case is the SO-8 package. With a maximum die temperature of 150°C and a maximum ambient temperature of 85°C, the 65°C temperature rise and package thermal resistance of 170°C/W gives a dissipation of 382mW at 85°C. This allows a maximum supply voltage of  $\pm 8.5V$  for the EL4431 operated in our example. If an EL4430 were driving a light load ( $R_{PAR} \rightarrow \infty$ ), it could operate on  $\pm 15V$  supplies at a 70°C maximum ambient.

### **Output Loading**

The output stage of the instrumentation amplifiers is very powerful. It typically can source 80mA and sink 120mA. Of course, this is too much current to sustain and the part will eventually be destroyed by excessive dissipation or by metal traces on the die opening. The metal traces are completely reliable while delivering the 30mA continuous output given in the Absolute Maximum Ratings table in this datasheet, or higher purely transient currents.

Gain or gain accuracy degrades only 10% from no load to 100 $\Omega$  load. Heavy resistive loading will degrade frequency response and video distortion for loads <100 $\Omega$ .

Capacitive loads will cause peaking in the frequency response. If capacitive loads must be driven, a small-valued series resistor can be used to isolate it (12 $\Omega$  to 51 $\Omega$  should suffice). A 22 $\Omega$  series resistor will limit peaking to 2.5dB with even a 220pF load.



**EL4430,EL4431 Macromodel**

\*Macromodel

\*This is a Pspice-compatible macromodel of the EL4430 video instrumentation amplifier assembled

\*as a sub circuit. The pins are numbered sequentially as the subcircuit interface nodes. T1 is a

\*transmission line which provides a good emulation of the more complicated real device. This model

\*correctly displays the characteristics of input clipping, frequency response, CMRR both AC and DC,

\*output clipping, output sensitivity to capacitive loads, gain accuracy, slewrate limiting, input bias

\*current and impedance. The macromodel does not exhibit proper results with respect to supply current,

\*supply sensitivities, offsets, output current limit, differential gain or phase, nor temperature.

\*Connections:

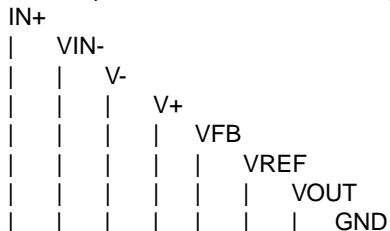

```
.SUBCKT EL4430/EL 3 4 2 7 6 5 8 1
```

\*\*\*

\*\*\*EL4430macromodel\*\*\*

\*\*\*

i1710.00103

i2711.00103

i3712.00105

i4713.00105

v17143

v27153

v31923

\*\*\*\*\*

c1111.03p

c2121.03p

c31812.1p

c416170.6p

\*\*\*\*\*

r110112000

r212132000

r310130e6

r41621000

r51721000

r61811.27e6

r7232120

r8218100

\*\*\*\*\*

1121850n

\*\*\*\*\*

d11114diode

d21214diode

d31815diode

d41918diode

.modeldiode(tt=120n)

\*\*\*\*\*

q1163101pnp

q2174111pnp

q3165121pnp

q4176131pnp

.modelpnppnp(bf=90va=44tr=50n)

\*\*\*\*\*

g11811716.0005

e12011181.0  
t1221201z0=50td=1.5n  
r1t122150  
e22312211.0  
\*\*\*\*\*  
.ENDS

All Intersil U.S. products are manufactured, assembled and tested utilizing ISO9000 quality systems.  
Intersil Corporation's quality certifications can be viewed at [www.intersil.com/design/quality](http://www.intersil.com/design/quality)

---

*Intersil products are sold by description only. Intersil Corporation reserves the right to make changes in circuit design, software and/or specifications at any time without notice. Accordingly, the reader is cautioned to verify that data sheets are current before placing orders. Information furnished by Intersil is believed to be accurate and reliable. However, no responsibility is assumed by Intersil or its subsidiaries for its use; nor for any infringements of patents or other rights of third parties which may result from its use. No license is granted by implication or otherwise under any patent or patent rights of Intersil or its subsidiaries.*

---

For information regarding Intersil Corporation and its products, see [www.intersil.com](http://www.intersil.com)