

SMD Zener Diode



SMD Diodes Specialist

CZRW5221B-HF Thru CZRW5267B-HF

Voltage: 2.4 to 75 Volts

Power: 500 mWatts

RoHS Device

Features

Halogen free.

For surface mounted applications.

500mW Power Dissipation.

Ideally suited for automated assembly processes.

Pb free product.

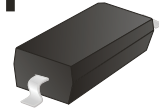

Mechanical data

Case: SOD-123, Molded plastic.

Terminals: Solder Plated, solderable per MIL-STD-750, method 2026.

Polarity: Cathode band.

Weight: 0.01 gram (approx.).

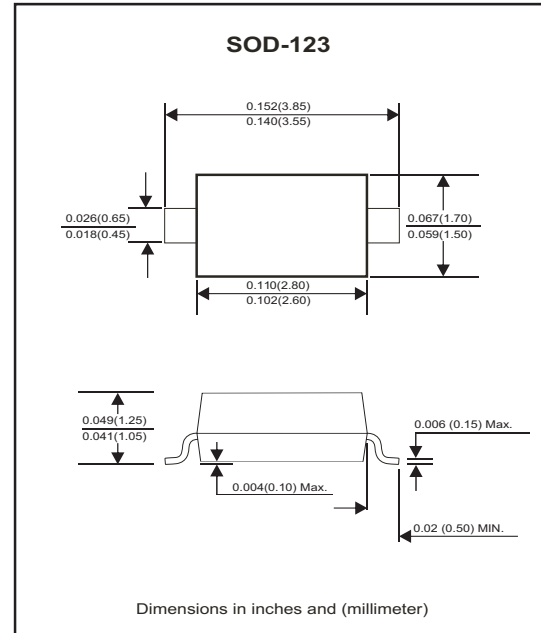

Maximum Rating AND Electrical Characteristics

Parameter	Symbol	Value	Unit
Maximum Power Dissipation, $T_A = 25^\circ\text{C}$	P_D	500	mW
Operating Junction and Storage Temperature Range	T_J	-55 to +150	$^\circ\text{C}$

Electrical Characteristics(Ta = 25°C)

Part Number	Zener Voltage			Operating resistance		Rising operating resistance		Reverse current		Marking Code
	Vz(V)@IzT			ZzT(Ohm)		Zzk(Ohm)		I _R (uA)		
	Min	Nom	Max	Max	IzT(mA)	Max	Izk(mA)	Max	V _R (V)	
CZRW5221B-HF	2.28	2.4	2.52	30	20	1200	0.25	100	1	C1
CZRW5222B-HF	2.38	2.5	2.63	30	20	1250	0.25	100	1	C2
CZRW5223B-HF	2.57	2.7	2.84	30	20	1300	0.25	75	1	C3
CZRW5225B-HF	2.85	3	3.15	30	20	1600	0.25	50	1	C5
CZRW5226B-HF	3.14	3.3	3.47	28	20	1600	0.25	25	1	D1
CZRW5227B-HF	3.42	3.6	3.78	24	20	1700	0.25	15	1	D2
CZRW5228B-HF	3.71	3.9	4.1	23	20	1900	0.25	10	1	D3
CZRW5229B-HF	4.09	4.3	4.52	22	20	2000	0.25	5	1	D4
CZRW5230B-HF	4.47	4.7	4.94	19	20	1900	0.25	5	2	D5
CZRW5231B-HF	4.85	5.1	5.36	17	20	1600	0.25	5	2	E1
CZRW5232B-HF	5.32	5.6	5.88	11	20	1600	0.25	5	3	E2
CZRW5234B-HF	5.89	6.2	6.51	7	20	1000	0.25	5	4	E4
CZRW5235B-HF	6.46	6.8	7.14	5	20	750	0.25	3	5	E5
CZRW5236B-HF	7.13	7.5	7.88	6	20	500	0.25	3	6	F1
CZRW5237B-HF	7.79	8.2	8.61	8	20	500	0.25	3	6	F2
CZRW5239B-HF	8.65	9.1	9.56	10	20	600	0.25	3	6.5	F4
CZRW5240B-HF	9.5	10	10.5	17	20	600	0.25	3	8	F5
CZRW5241B-HF	10.45	11	11.55	22	20	600	0.25	3	8.4	H1
CZRW5242B-HF	11.4	12	12.6	30	20	600	0.25	2	9.1	H2
CZRW5243B-HF	12.35	13	13.65	13	9.5	600	0.25	1	9.9	H3
CZRW5244B-HF	13.3	14	14.7	15	9.0	600	0.25	0.5	10.5	H4
CZRW5245B-HF	14.25	15	15.75	16	8.5	600	0.25	0.5	11	H5
CZRW5246B-HF	15.2	16	16.8	17	7.8	600	0.25	0.1	12	J1
CZRW5247B-HF	16.15	17	17.85	19	7.5	600	0.25	0.1	13	J2
CZRW5248B-HF	17.1	18	18.9	21	7	600	0.25	0.1	14	J3
CZRW5250B-HF	19	20	21	25	6.2	600	0.25	0.1	15	J5
CZRW5251B-HF	20.9	22	23.1	29	5.6	600	0.25	0.1	17	K1
CZRW5252B-HF	22.8	24	25.2	33	5.2	600	0.25	0.1	18	K2
CZRW5254B-HF	25.65	27	28.35	41	5	600	0.25	0.1	21	K4
CZRW5255B-HF	26.6	28	29.4	44	4.5	600	0.25	0.1	21	K5
CZRW5256B-HF	28.5	30	31.5	49	4.2	600	0.25	0.1	23	M1
CZRW5257B-HF	31.35	33	34.65	58	3.8	700	0.25	0.1	25	M2
CZRW5258B-HF	34.2	36	37.8	70	3.4	700	0.25	0.1	27	M3
CZRW5259B-HF	37.05	39	40.95	80	3.2	800	0.25	0.1	30	M4
CZRW5260B-HF	40.85	43	45.15	93	3	900	0.25	0.1	33	M5
CZRW5261B-HF	44.65	47	49.35	105	2.7	1000	0.25	0.1	36	N1
CZRW5262B-HF	48.45	51	53.55	125	2.5	1100	0.25	0.1	39	N2
CZRW5263B-HF	53.2	56	58.8	150	2.2	1300	0.25	0.1	43	N3
CZRW5264B-HF	57	60	63	170	2.1	1400	0.25	0.1	46	N4
CZRW5265B-HF	58.9	62	65.1	185	2	1500	0.25	0.1	47	N5
CZRW5266B-HF	64.6	68	71.4	230	1.8	1600	0.25	0.1	52	P1
CZRW5267B-HF	71.25	75	78.75	270	1.7	1400	0.25	0.1	56	P2

RATING AND CHARACTERISTIC CURVES (CZRW5221B-HF Thru CZRW5267B-HF)

Fig.1 Typical forward voltage

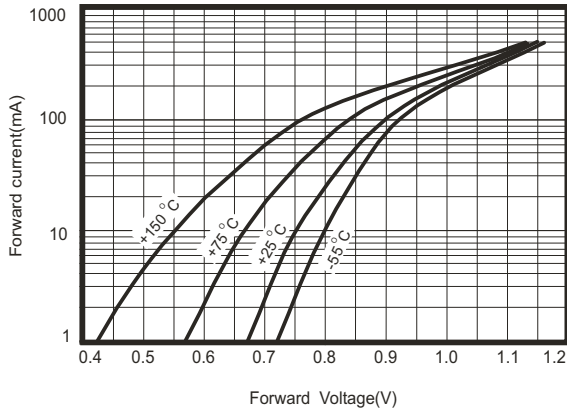

Fig.2 Typical leakage current

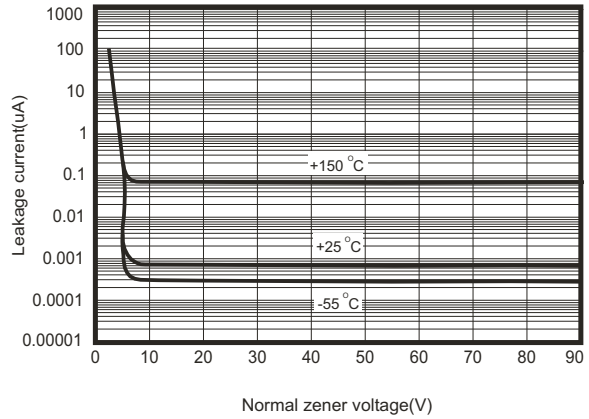

Fig.3 Temperature coefficients

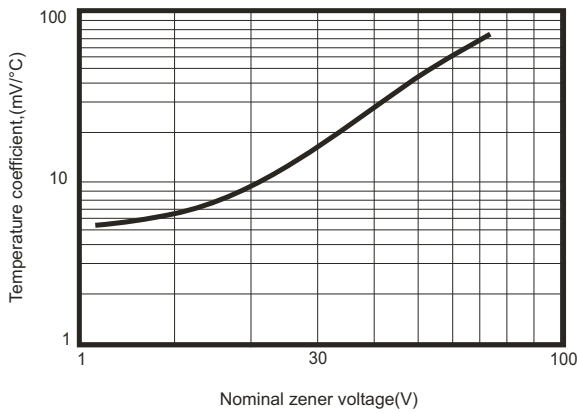
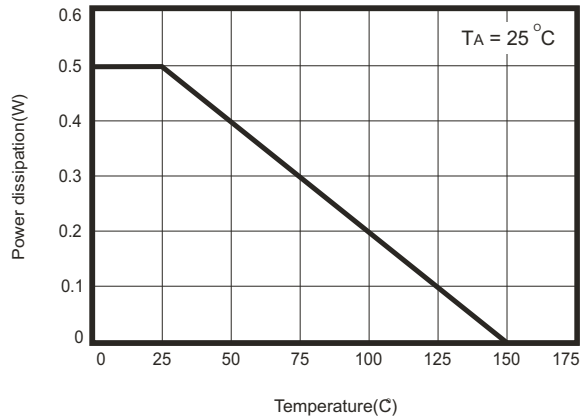
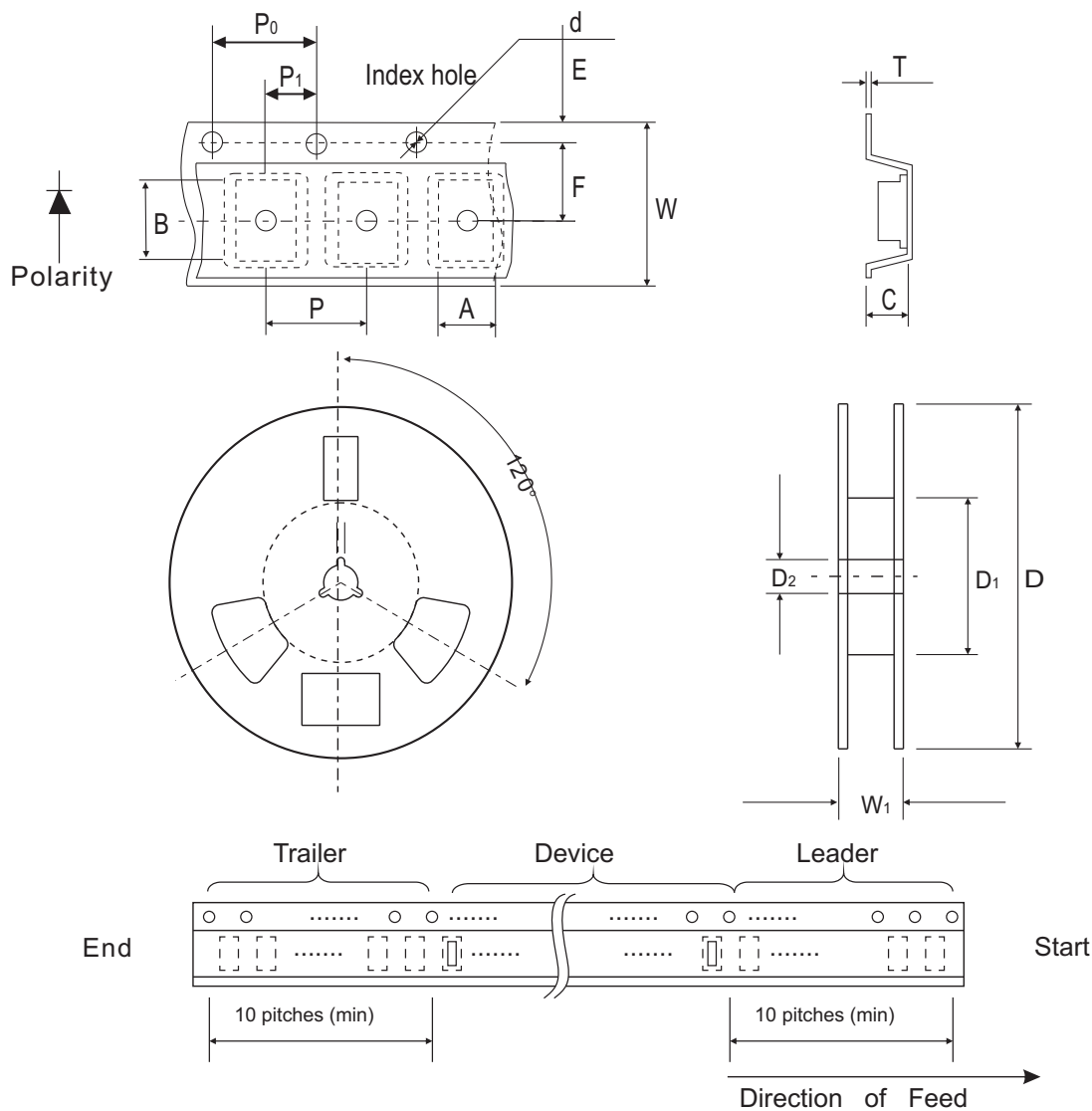

Fig.4 Steady state power derating



Reel Taping Specification



SOD-123	SYMBOL	A	B	C	d	D	D ₁	D ₂
	(mm)	1.90 ± 0.10	4.00 ± 0.10	1.50 ± 0.10	1.55 ± 0.10	178 ± 1	50.0 MIN.	13.0 ± 0.20
	(inch)	0.074 ± 0.004	0.157 ± 0.004	0.059 ± 0.004	0.061 ± 0.004	7.008 ± 0.04	1.968 MIN.	0.512 ± 0.008
SOD-123	SYMBOL	E	F	P	P ₀	P ₁	W	W ₁
	(mm)	1.75 ± 0.10	3.50 ± 0.05	4.00 ± 0.10	4.00 ± 0.10	2.00 ± 0.05	8.00 ± 0.30	14.4 MAX.
	(inch)	0.069 ± 0.004	0.138 ± 0.002	0.157 ± 0.004	0.157 ± 0.004	0.079 ± 0.002	0.315 ± 0.012	0.567 MAX.

Marking Code

Part Number	Marking Code
CZRW5221B ~ 5267B-HF	XX



Suggested PAD Layout

SIZE	SOD-123	
	(mm)	(inch)
A	3.35	0.132
B	0.80	0.032
C	1.00	0.039
D	5.025	0.198
E	1.675	0.066

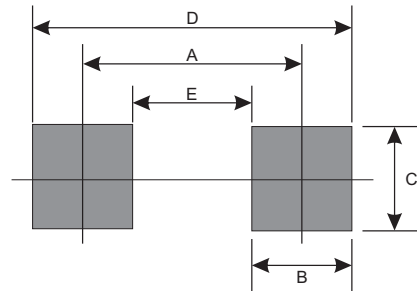

Standard Package

Case Type	Qty per Reel	Reel Size
	(Pcs)	(inch)
SOD-123	3000	7