

Features

- 200MHz -3dB bandwidth, $A_V = 2$
- 12ns settling to 0.05%
- $V_S = \pm 5V @ 15mA$
- Low distortion: HD2, HD3 @ -60dBc at 20MHz
- Differential gain 0.02% at NTSC, PAL
- Differential phase 0.01° at NTSC, PAL
- Overload/short-circuit protected
- ± 1 to ± 8 closed-loop gain range
- Low cost
- Direct replacement for CLC400

Applications

- Video gain block
- Video distribution
- HDTV amplifier
- High-speed A/D conversion
- D/A I-V conversion
- Photodiode, CCD preamps
- IF processors
- High-speed communications

Ordering Information

Part No.	Temp. Range	Package	Outline #
EL400CN	-40°C to +85°C	8-Pin P-DIP	MDP0031
EL400CS	-40°C to +85°C	8-Lead SO	MDP0027

General Description

The EL400C is a wide bandwidth, fast settling monolithic amplifier built using an advanced complementary bipolar process. This amplifier uses current-mode feedback to achieve more bandwidth at a given gain than conventional operational amplifiers. Designed for closed-loop gains of ± 1 to ± 8 , the EL400C has a 200MHz -3dB bandwidth ($A_V = +2$), and 12ns settling to 0.05% while consuming only 15mA of supply current.

The EL400C is an obvious high-performance solution for video distribution and line-driving applications. With low 15mA supply current, differential gain/phase of 0.02%/0.01°, and a minimum 50mA output drive, performance in these areas is assured.

The EL400's settling to 0.05% in 12ns, low distortion, and ability to drive capacitive loads make it an ideal flash A/D driver. The wide 200MHz bandwidth and extremely linear phase allow unmatched signal fidelity. D/A systems can also benefit from the EL400C, especially if linearity and drive levels are important.

Connection Diagrams

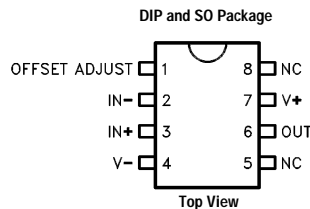

Manufactured under U.S. Patent No. 4,893,091

Note: All information contained in this data sheet has been carefully checked and is believed to be accurate as of the date of publication; however, this data sheet cannot be a "controlled document". Current revisions, if any, to these specifications are maintained at the factory and are available upon your request. We recommend checking the revision level before finalization of your design documentation.

© 2001 Elantec Semiconductor, Inc.

September 26, 2001

EL400C**200MHz Current Feedback Amplifier****Absolute Maximum Ratings** ($T_A = 25^\circ\text{C}$)

Supply Voltage (V_S)	$\pm 7\text{V}$	Operating Temperature	-40°C to $+85^\circ\text{C}$
Output Current		Lead Temperature (Soldering, 5 Seconds)	300°C
Output is short-circuit protected to ground, however, maximum reliability is obtained if I_{OUT} does not exceed 70mA.		Junction Temperature	175°C
Common-Mode Input Voltage	$\pm V_S$	Storage Temperature	-60°C to $+150^\circ\text{C}$
Differential Input Voltage	5V	Thermal Resistance:	
Power Dissipation	See Curves	$\theta_{JA} = 95^\circ\text{C/W}$ P-DIP	
		$\theta_{JA} = 175^\circ\text{C/W}$ SO-8	

Important Note:

All parameters having Min/Max specifications are guaranteed. Typ values are for information purposes only. Unless otherwise noted, all tests are at the specified temperature and are pulsed tests, therefore: $T_J = T_C = T_A$.

Open Loop DC Electrical Characteristics

$V_S = \pm 5\text{V}$, $R_L = 100\Omega$ unless otherwise specified

Parameter	Description	Test Conditions	Temp	Min	Typ	Max	Unit
V_{OS}	Input Offset Voltage		25°C		2.0	5.5	mV
			T_{MIN}			8.7	mV
			T_{MAX}			9.5	mV
$d(V_{\text{OS}})/dT$	Average Offset Voltage Drift	[1]	All		10.0	40.0	$\mu\text{V}/^\circ\text{C}$
$+I_{\text{IN}}$	+Input Current		25°C , T_{MAX}		10.0	25.0	μA
			T_{MIN}			41.0	μA
$d(+I_{\text{IN}})/dT$	Average +Input Current Drift	[1]	All		50.0	200.0	$\text{nA}/^\circ\text{C}$
$-I_{\text{IN}}$	-Input Current		25°C		10.0	25.0	μA
			T_{MIN}			41.0	μA
			T_{MAX}			35.0	μA
$d(-I_{\text{IN}})/dT$	Average -Input Current Drift	[1]	All		100.0	200.0	$\text{nA}/^\circ\text{C}$
PSRR	Power Supply Rejection Ratio		All	40.0	50.0		dB
CMRR	Common-Mode Rejection Ratio		All	40.0	50.0		dB
I_S	Supply Current—Quiescent	No Load	All		15.0	23.0	mA
$+R_{\text{IN}}$	+Input Resistance		25°C , T_{MAX}	100.0	200.0		$\text{k}\Omega$
			T_{MIN}	50.0			$\text{k}\Omega$
C_{IN}	Input Capacitance		All		0.5	2.0	pF
R_{OUT}	Output Impedance (DC)		All		0.1	0.2	Ω
CMIR	Common-Mode Input Range		25°C , T_{MAX}	2.0	2.1		V
			T_{MIN}	1.2			V
I_{OUT}	Output Current		25°C , T_{MAX}	50.0	70.0		mA
			T_{MIN}	35.0			mA
V_{OUT}	Output Voltage Swing	No Load	All	3.2	3.5		V
V_{OUTL}	Output Voltage Swing	100Ω	25°C	3.0	3.4		V
R_{OL}	Transimpedance		25°C	30.0	125.0		V/mA
			T_{MIN}		80.0		V/mA
			T_{MAX}		140.0		V/mA

1. Measured from T_{MIN} to T_{MAX} .

2. Common-Mode Input Range for Rated Performance.

Closed-Loop AC Electrical Characteristics

$V_S = \pm 5V$, $R_F = 250\Omega$, $A_V = +2$, $R_L = 100\Omega$ unless otherwise specified

Parameter	Description	Test Conditions	Temp	Min	Typ	Max	Unit
Frequency Response	SSBW -3dB Bandwidth ($V_{OUT} < 0.5V_{PP}$)		25°C	150.0	200.0		MHz
			T_{MIN}	150.0			MHz
			T_{MAX}	120.0			MHz
	LSBW -3dB Bandwidth ($V_{OUT} < 5.0V_{PP}$)	$A_V = +5$	All	35.0	50.0		MHz
Gain Flatness	GFPL Peaking $V_{OUT} < 0.5V_{PP}$	<40MHz	25°C		0.0	0.3	dB
			T_{MIN}, T_{MAX}			0.4	dB
	GFPH Peaking $V_{OUT} < 0.5V_{PP}$	>40MHz	25°C		0.0	0.5	dB
			T_{MIN}, T_{MAX}			0.7	dB
	GFR Rolloff $V_{OUT} < 0.5V_{PP}$	<75MHz	25°C		0.6	1.0	dB
			T_{MIN}			1.0	dB
T_{MAX}					1.3	dB	
LPD Linear Phase Deviation $V_{OUT} < 0.5V_{PP}$	<75MHz	25°C, T_{MIN}		0.2	1.0	°	
		T_{MAX}			1.2	°	
Time-Domain Response	t_{r1}, t_{f1} Rise Time, Fall Time	0.5V Step	25°C, T_{MIN}		1.6	2.4	ns
			T_{MAX}			2.9	ns
	t_{r2}, t_{f2} Rise Time, Fall Time	5.0V Step	All		6.5	10.0	ns
	t_{s1} Settling Time to 0.1%	2.0V Step	All		10.0	13.0	ns
	t_{s2} Settling Time to 0.05%	2.0V Step	All		12.0	15.0	ns
			OS Overshoot	0.5V Step	25°C		0.0
SR Slew Rate		$A_V = +2$ $A_V = -2$	All	430.0	700.0		V/ μ s
			All		1600.0		V/ μ s
Distortion	HD2 2nd Harmonic Distortion at 20MHz	2V _{pp}	25°C		-60.0	-45.0	dBc
			T_{MIN}			-40.0	dBc
			T_{MAX}			-45.0	dBc
	HD3 3rd Harmonic Distortion at 20MHz	2V _{pp}	25°C		-60.0	-50.0	dBc
T_{MIN}, T_{MAX}					-50.0	dBc	
Equivalent Input Noise	NF Noise Floor >100kHz	[1]	25°C		-157.0	-154.0	dBm (1Hz)
			T_{MIN}			-154.0	dBm (1Hz)
			T_{MAX}			-153.0	dBm (1Hz)
INV	Integrated Noise 100kHz to 200MHz	[1]	25°C		40.0	57.0	μ V
			T_{MIN}			57.0	μ V
			T_{MAX}			63.0	μ V
Video Performance	d _G Differential Gain [2]	NTSC/PAL	25°C		0.02		% pp
	d _P Differential Phase [2]	NTSC/PAL	25°C		0.01		° pp
	d _G Differential Gain [2]	30MHz	25°C		0.05		% pp
	d _P Differential Phase [2]	30MHz	25°C		0.05		° pp
	VBW -0.1dB Bandwidth [2]		25°C		60.0		MHz

1. Noise Tests are Performed from 5MHz to 200MHz.

2. Differential Gain/Phase Tests are $R_L = 100\Omega$. For other values of R_L , see curves.

EL400C

200MHz Current Feedback Amplifier

Typical Performance Curves

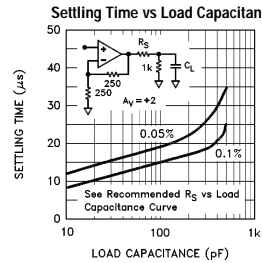
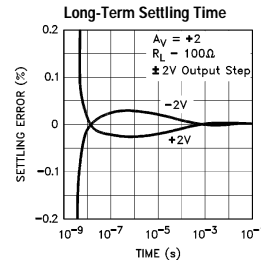
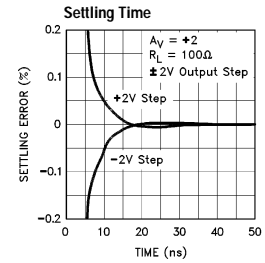
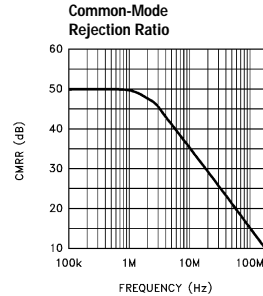
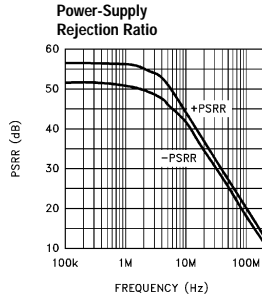
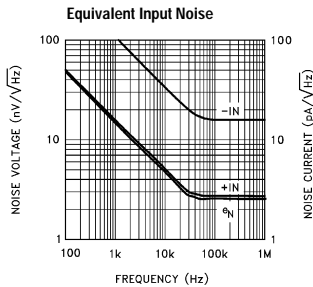
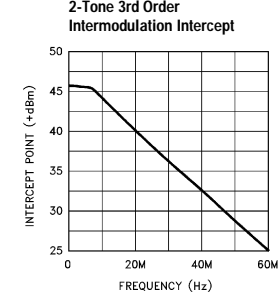
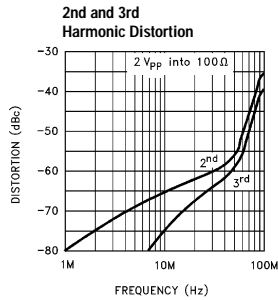
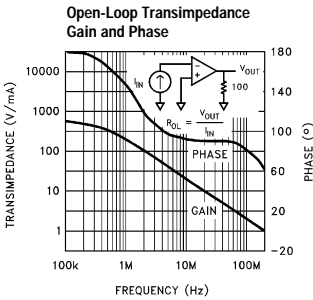
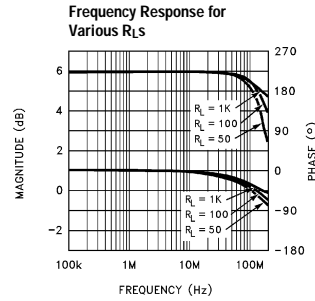
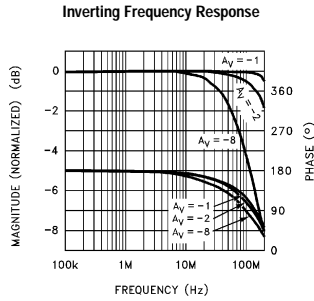
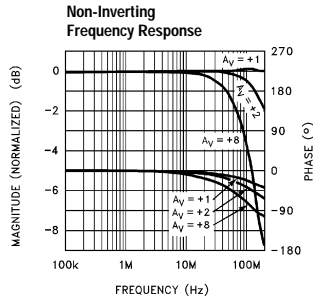

EL400C

200MHz Current Feedback Amplifier

EL400C

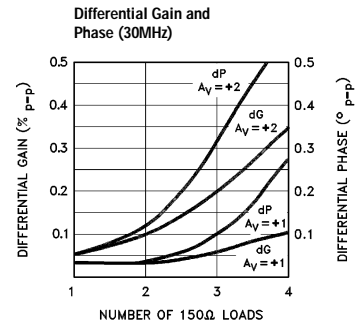
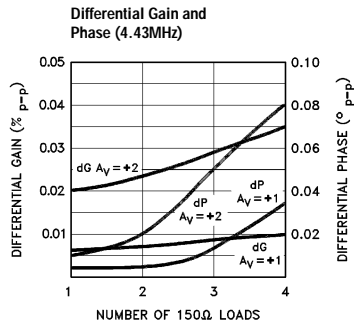
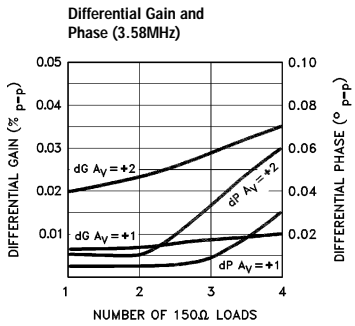
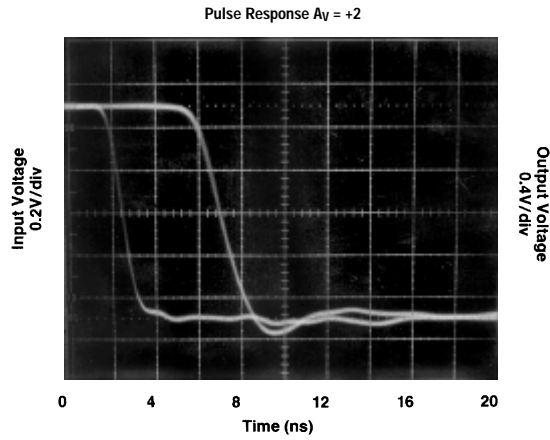
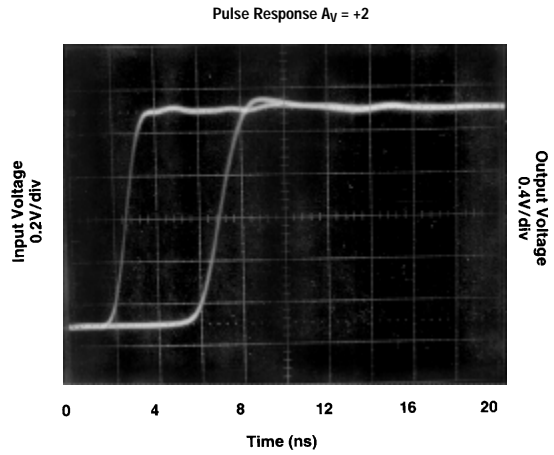
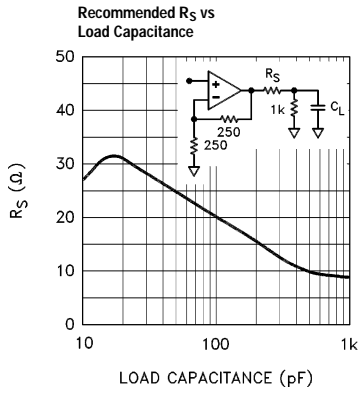

EL400C

200MHz Current Feedback Amplifier

Equivalent Circuit

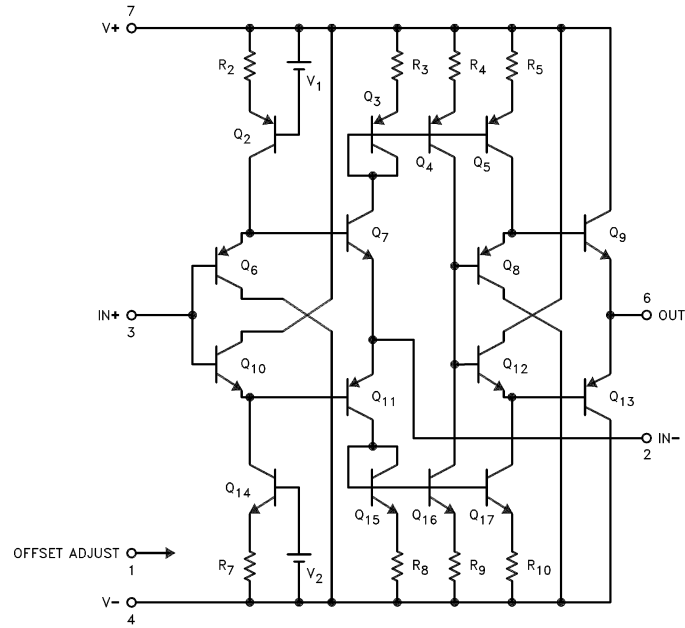

Burn-In Circuit

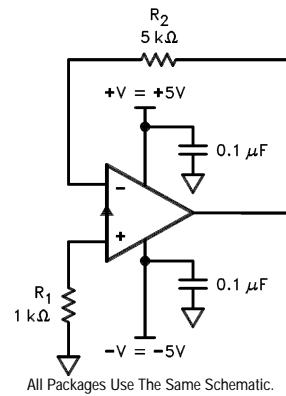

Applications Information

Theory of Operation

The EL400C has a unity gain buffer from the non-inverting input to the inverting input. The error signal of the EL400C is a current flowing into (or out of) the inverting input. A very small change in current flowing through the inverting input will cause a large change in the output voltage. This current amplification is called the transimpedance (R_{OL}) of the EL400C [$V_{OUT}=(R_{OL})*(-I_{IN})$]. Since R_{OL} is very large, the current flowing into the inverting input in the steady-state (non-slewing) condition is very small.

Therefore we can still use op-amp assumptions as a first-order approximation for circuit analysis, namely that:

1. The voltage across the inputs is approximately 0V.
2. The current into the inputs is approximately 0mA.

Resistor Value Selection and Optimization

The value of the feedback resistor (and an internal capacitor) sets the AC dynamics of the EL400C. The nominal value for the feedback resistor is 250 Ω , which is the value used for production testing. This value guarantees stability. For a given closed-loop gain the bandwidth may be increased by decreasing the feedback resistor and, conversely, the bandwidth may be decreased by increasing the feedback resistor.

Reducing the feedback resistor too much will result in overshoot and ringing, and eventually oscillations. Increasing the feedback resistor results in a lower -3dB frequency. Attenuation at high frequency is limited by a zero in the closed-loop transfer function which results from stray capacitance between the inverting input and ground. Consequently, it is very important to keep stray capacitance to a minimum at the inverting input.

Differential Gain/Phase

An industry-standard method of measuring the distortion of a video component is to measure the amount of differential gain and phase error it introduces. To measure these, a 40 IRE_{PP} reference signal is applied to the device with 0V DC offset (0IRE) at 3.58MHz for NTSC, 4.43MHz for PAL, and 30MHz for HDTV. A second

measurement is then made with a 0.714V DC offset (100IRE). Differential Gain is a measure of the change in amplitude of the sine wave, and is measured in percent. Differential Phase is a measure of the change in phase, and is measured in degrees. Typically, the maximum positive and negative deviations are summed to give peak values.

In general, a back terminated cable (75 Ω in series at the drive end and 75 Ω to ground at the receiving end) is preferred since the impedance match at both ends will absorb any reflections. However, when double-termination is used, the received signal is reduced by half; therefore a gain of 2 configuration is typically used to compensate for the attenuation. In a gain of 2 configuration, with output swing of 2V_{PP}, with each back-terminated load at 150 Ω . The EL400C is capable of driving up to 4 back-terminated loads with excellent video performance. Please refer to the typical curves for more information on video performance with respect to frequency, gain, and loading.

Capacitive Feedback

The EL400C relies on its feedback resistor for proper compensation. A reduction of the impedance of the feedback element results in less stability, eventually resulting in oscillation. Therefore, circuit implementations which have capacitive feedback should not be used because of the capacitor's impedance reduction with frequency. Similarly, oscillations can occur when using the technique of placing a capacitor in parallel with the feedback resistor to compensate for shunt capacitances from the inverting input to ground.

Offset Adjustment Pin

Output offset voltage of the EL400C can be nulled by tying a 10k potentiometer between +V_S and -V_S with the slider attached to pin 1. A full-range variation of the voltage at pin 1 to $\pm 5V$ results in an offset voltage adjustment of at least $\pm 10mV$. For best settling performance pin 1 should be bypassed to ground with a ceramic capacitor located near to the package, even if the offset voltage adjustment feature is not being used.

EL400C

200MHz Current Feedback Amplifier

Printed Circuit Layout

As with any high frequency device, good PCB layout is necessary for optimum performance. Ground plane construction is a requirement, as is good power-supply and Offset Adjust bypassing close to the package. The inverting input is sensitive to stray capacitance, therefore connections at the inverting input should be minimal, close to the package, and constructed with as little coupling the ground plane as possible.

Capacitance at the output node will reduce stability, eventually resulting in peaking, and finally oscillation if the capacitance is large enough. The design of the EL400C allows a larger capacitive load than comparable products, yet there are occasions when a series resistor before the capacitance may be needed. Please refer to the graphs to determine the proper resistor value needed.

EL400C Macromodel

```

* Revision A. March 1992
* Enhancements include PSRR, CMRR, and Slew Rate Limiting
* Connections:  +input
*               |
*               | -input
*               |
*               | +Vsupply
*               | |
*               | | -Vsupply
*               | |
*               | | output
*               | |
.subckt M400 3 2 7 4 6
*
* Input Stage
*
e1 10 0 3 0 1.0
vis 10 9 0V
h2 9 12 vxx 1.0
r1 2 11 50
l1 11 12 48nH
iinp 3 0 8μA
iinm 2 0 8μA
*
* Slew Rate Limiting
*
h1 13 0 vis 600
r2 13 14 1K
d1 14 0 dclamp
d2 0 14 dclamp
*
* High Frequency Pole
*
*e2 30 0 14 0 0.001666666666
l3 30 17 0.1μH
c5 17 0 0.1pF
r5 17 0 500
*
* Transimpedance Stage
*
g1 0 18 17 0 1.0
rol 18 0 150K
cdp 18 0 2.8pF
*
* Output Stage
*
q1 4 18 19 qp
q2 7 18 20 qn
q3 7 19 21 qn
q4 4 20 22 qp
r7 21 6 2
r8 22 6 2

ios1 7 19 2.5mA
ios2 20 4 2.5mA
*
* Supply Current
*
ips 7 4 9mA
*
* Error Terms
*
ivos 0 23 5mA
vxx 23 0 0V
e4 24 0 3 0 1.0
e5 25 0 7 0 1.0

```

EL400C

200MHz Current Feedback Amplifier

```

e6 26 0 4 0 1.0
r9 24 23 3K
r10 25 23 1K
r11 26 23 1K
*
* Models
*
.model qn npn (is=5e-15 bf=200 tf=0.5nS)
.model qp pnp (is=5e-15 bf=200 tf=0.5nS)
.model dclamp d(is=1e-30 ibv=0.266 bv=1.3 n=4)
.ends
    
```

EL400C Macromodel

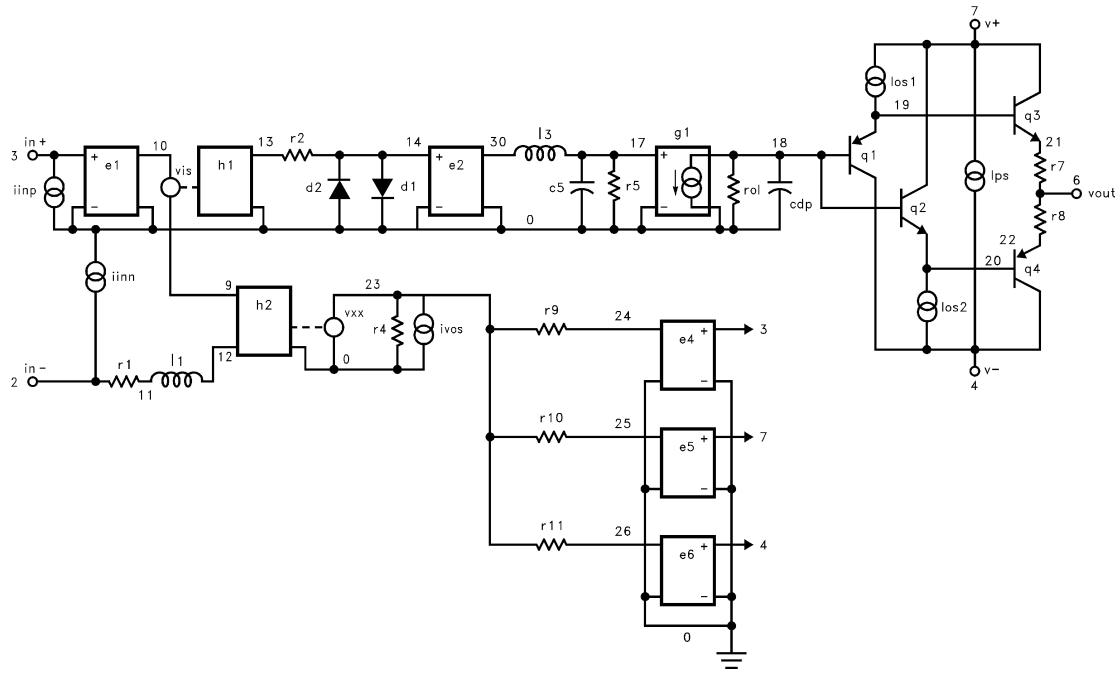

EL400C

200MHz Current Feedback Amplifier

General Disclaimer

Specifications contained in this data sheet are in effect as of the publication date shown. Elantec, Inc. reserves the right to make changes in the circuitry or specifications contained herein at any time without notice. Elantec, Inc. assumes no responsibility for the use of any circuits described herein and makes no representations that they are free from patent infringement.

élantec

HIGH PERFORMANCE ANALOG INTEGRATED CIRCUITS

Elantec Semiconductor, Inc.

675 Trade Zone Blvd.

Milpitas, CA 95035

Telephone: (408) 945-1323

(888) ELANTEC

Fax: (408) 945-9305

European Office: +44-118-977-6020

Japan Technical Center: +81-45-682-5820

WARNING - Life Support Policy

Elantec, Inc. products are not authorized for and should not be used within Life Support Systems without the specific written consent of Elantec, Inc. Life Support systems are equipment intended to support or sustain life and whose failure to perform when properly used in accordance with instructions provided can be reasonably expected to result in significant personal injury or death. Users contemplating application of Elantec, Inc. Products in Life Support Systems are requested to contact Elantec, Inc. factory headquarters to establish suitable terms & conditions for these applications. Elantec, Inc.'s warranty is limited to replacement of defective components and does not cover injury to persons or property or other consequential damages.