

Features

- ◆ Silicon Planar Power Zener Diodes.
- ◆ For use as low voltage stabilizer or voltage reference.
- ◆ The Zener voltages are graded according to the international E 24 standard. Higher Zener voltages and 1% tolerance available on request.
- ◆ Diodes available in these tolerance series:
±2% BZV55-B, ±3% BZV55-F, ±5% BZV55-C.

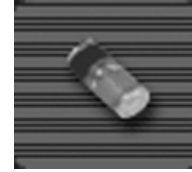

Mechanical Data

- ◆ Case: MiniMELF Glass Case (SOD-80)
- ◆ Weight: approx. 0.05g
- ◆ Cathode Band Color: Blue

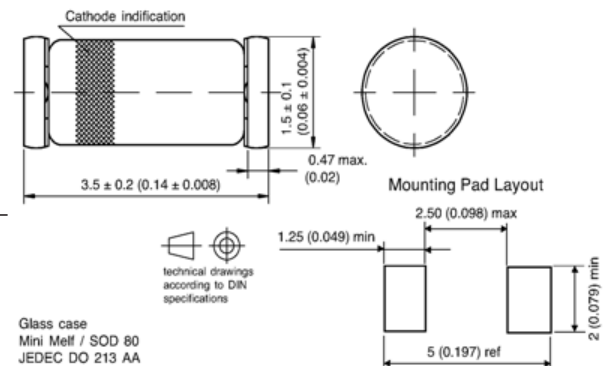

Maximum Ratings and Thermal Characteristics

($T_A = 25^\circ\text{C}$ unless otherwise noted)

Parameter	Symbol	Value	Unit
Zener current (see Table "Characteristics")			
Power dissipation at $T_{\text{flange}} = 50^\circ\text{C}$	P_{tot}	500	mW
Power dissipation at $T_A = 50^\circ\text{C}$	P_{tot}	400 ⁽¹⁾	mW
Junction temperature	T_j	-65 to +175	$^\circ\text{C}$
Storage temperature range	T_s	-65 to +175	$^\circ\text{C}$
Continuous forward current	I_F	250	mA
Thermal resistance junction to ambient air	$R_{\theta JA}$	0.38 ⁽¹⁾	$^\circ\text{C}/\text{mW}$
Thermal resistance junction to lead	$R_{\theta JL}$	0.30	$^\circ\text{C}/\text{mW}$
Peak reverse power dissipation (non-repetitive) $t_p = 100\mu\text{s}$	P_{ZSM}	30 ⁽²⁾	W

- Notes:**
1. Mounted on ceramic substrate 10mm x 10mm x 0.6mm
 2. $T_j = 150^\circ\text{C}$

Electrical Characteristics

(T_A=25°C unless otherwise noted) Maximum V_F=0.9V at I_F=10mA

Type number y=B for ±2% V _Z y=F for ±3% V _Z y=C for ±5% V _Z	Dynamic resistance		Temp. coefficient of zener voltage at I _Z =5mA α _{VZ} (% / °C)		Reverse leakage current at T _{amb} =25°C	
	at I _Z =5mA f=1kHz r _{ZI} (Ω) Max.	at I _Z =1mA f=1kHz r _{ZI} (Ω) Max.	Min.	Max.	I _R (μA)	at V _R (Volts)
BZV55 - y2V4	100	600	- 0.08	- 0.06	50	1
BZV55 - y2V7	100	600	- 0.08	- 0.06	20	1
BZV55 - y3V0	95	600	- 0.08	- 0.06	10	1
BZV55 - y3V3	95	600	- 0.08	- 0.05	5	1
BZV55 - y3V6	90	600	- 0.08	- 0.04	5	1
BZV55 - y3V9	90	600	- 0.07	- 0.03	3	1
BZV55 - y4V3	90	600	- 0.04	- 0.01	3	1
BZV55 - y4V7	80	500	- 0.03	+ 0.01	3	2
BZV55 - y5V1	60	480	- 0.02	+ 0.05	2	2
BZV55 - y5V6	40	400	- 0.01	+ 0.06	1	2
BZV55 - y6V2	10	150	0	+ 0.07	3	4
BZV55 - y6V8	15	80	+ 0.01	+ 0.08	2	4
BZV55 - y7V5	15	80	+ 0.01	+ 0.09	1	5
BZV55 - y8V2	15	80	+ 0.01	+ 0.09	0.7	5
BZV55 - y9V1	15	100	+ 0.02	+ 0.10	0.5	6
BZV55 - y10	20	150	+ 0.03	+ 0.11	0.2	7
BZV55 - y11	20	150	+ 0.03	+ 0.11	0.1	8
BZV55 - y12	25	150	+ 0.03	+ 0.11	0.1	8
BZV55 - y13	30	170	+ 0.03	+ 0.11	0.1	8
BZV55 - y15	30	200	+ 0.03	+ 0.11	0.05	10
BZV55 - y16	40	200	+ 0.03	+ 0.11	0.05	11
BZV55 - y18	45	225	+ 0.03	+ 0.11	0.05	13
BZV55 - y20	55	225	+ 0.03	+ 0.11	0.05	14
BZV55 - y22	55	250	+ 0.03	+ 0.11	0.05	15
BZV55 - y24	70	250	+ 0.04	+ 0.12	0.05	17
BZV55 - y27	80 ⁽³⁾	300 ⁽⁴⁾	+ 0.04 ⁽³⁾	+ 0.12 ⁽³⁾	0.05	19
BZV55 - y30	80 ⁽³⁾	300 ⁽⁴⁾	+ 0.04 ⁽³⁾	+ 0.12 ⁽³⁾	0.05	21
BZV55 - y33	80 ⁽³⁾	325 ⁽⁴⁾	+ 0.04 ⁽³⁾	+ 0.12 ⁽³⁾	0.05	23
BZV55 - y36	90 ⁽³⁾	350 ⁽⁴⁾	+ 0.04 ⁽³⁾	+ 0.12 ⁽³⁾	0.05	25
BZV55 - y39	130 ⁽³⁾	350 ⁽⁴⁾	+ 0.04 ⁽³⁾	+ 0.12 ⁽³⁾	0.05	27
BZV55 - y43	150 ⁽³⁾	375 ⁽⁴⁾	+ 0.04 ⁽³⁾	+ 0.12 ⁽³⁾	0.05	30
BZV55 - y47	170 ⁽³⁾	375 ⁽⁴⁾	+ 0.04 ⁽³⁾	+ 0.12 ⁽³⁾	0.05	33
BZV55 - y51	180 ⁽³⁾	400 ⁽⁴⁾	+ 0.04 ⁽³⁾	+ 0.12 ⁽³⁾	0.05	36
BZV55 - y56	200 ⁽³⁾	425 ⁽⁴⁾	typ. +0.1 ⁽³⁾		0.05	39
BZV55 - y62	215 ⁽³⁾	450 ⁽⁴⁾	typ. +0.1 ⁽³⁾		0.05	43
BZV55 - y68	240 ⁽³⁾	475 ⁽⁴⁾	typ. +0.1 ⁽³⁾		0.05	48
BZV55 - y75	255 ⁽⁴⁾	500 ⁽⁴⁾	typ. +0.1 ⁽³⁾		0.05	53

- Notes:**
1. Tested with pulses t_p=5 ms.
 2. Valid provided that electrodes are kept at ambient temperature.
 3. at I_Z=2.0 mA
 4. at I_Z=0.5 mA
- y = Zener voltage tolerance designator (see next page for V_Z specifications)

Electrical Characteristics

(T_A=25°C unless otherwise noted) Maximum V_F=0.9V at I_F=10mA

Type number ±5% Tol.	Zener voltage range ⁽¹⁾ at I _Z =5mA V _Z (Volts)	
	Min.	Max.
BZV55-C2V4	2.20	2.60
BZV55-C2V7	2.50	2.90
BZV55-C3V0	2.80	3.20
BZV55-C3V3	3.10	3.50
BZV55-C3V6	3.40	3.80
BZV55-C3V9	3.70	4.10
BZV55-C4V3	4.00	4.60
BZV55-C4V7	4.40	5.00
BZV55-C5V1	4.80	5.40
BZV55-C5V6	5.20	6.00
BZV55-C6V2	5.80	6.60
BZV55-C6V8	6.40	7.20
BZV55-C7V5	7.00	7.90
BZV55-C8V2	7.70	8.70
BZV55-C9V1	8.50	9.60
BZV55-C10	9.40	10.60
BZV55-C11	10.40	11.60
BZV55-C12	11.40	12.70
BZV55-C13	12.40	14.10
BZV55-C15	13.80	15.60
BZV55-C16	15.30	17.10
BZV55-C18	16.80	19.10
BZV55-C20	18.80	21.20
BZV55-C22	20.80	23.30
BZV55-C24	22.80	25.60
BZV55-C27	25.10	28.90 ⁽³⁾
BZV55-C30	28.00	32.00 ⁽³⁾
BZV55-C33	31.00	35.00 ⁽³⁾
BZV55-C36	34.00	38.00 ⁽³⁾
BZV55-C39	37.00	41.00 ⁽³⁾
BZV55-C43	40.00	46.00 ⁽³⁾
BZV55-C47	44.00	50.00 ⁽³⁾
BZV55-C51	48.00	54.00 ⁽³⁾
BZV55-C56	52.00	60.00 ⁽³⁾
BZV55-C62	58.00	66.00 ⁽³⁾
BZV55-C68	64.00	72.00 ⁽³⁾
BZV55-C75	70.00	79.00 ⁽³⁾

Type number ±3% Tol.	Zener voltage range ⁽¹⁾ at I _Z =5mA V _Z (Volts)	
	Min.	Max.
BZV55-F2V4	2.33	2.47
BZV55-F2V7	2.62	2.78
BZV55-F3V0	2.91	3.09
BZV55-F3V3	3.20	3.40
BZV55-F3V6	3.49	3.71
BZV55-F3V9	3.78	4.02
BZV55-F4V3	4.17	4.43
BZV55-F4V7	4.56	4.84
BZV55-F5V1	4.95	5.25
BZV55-F5V6	5.43	5.77
BZV55-F6V2	6.01	6.39
BZV55-F6V8	6.60	7.00
BZV55-F7V5	7.28	7.72
BZV55-F8V2	7.95	8.45
BZV55-F9V1	8.83	9.37
BZV55-F10	9.70	10.30
BZV55-F11	10.67	11.33
BZV55-F12	11.64	12.36
BZV55-F13	12.61	13.39
BZV55-F15	14.55	15.45
BZV55-F16	15.50	16.50
BZV55-F18	17.50	18.50
BZV55-F20	19.40	20.60
BZV55-F22	21.30	22.70
BZV55-F24	23.30	24.70
BZV55-F27	26.20	27.80 ⁽³⁾
BZV55-F30	29.10	30.90 ⁽³⁾
BZV55-F33	32.00	34.00 ⁽³⁾
BZV55-F36	34.90	37.10 ⁽³⁾
BZV55-F39	37.80	40.20 ⁽³⁾
BZV55-F43	41.70	44.30 ⁽³⁾
BZV55-F47	45.60	48.40 ⁽³⁾
BZV55-F51	49.50	52.50 ⁽³⁾
BZV55-F56	54.30	57.70 ⁽³⁾
BZV55-F62	60.10	63.90 ⁽³⁾
BZV55-F68	66.00	70.00 ⁽³⁾
BZV55-F75	72.80	77.20 ⁽³⁾

Type number ±2% Tol.	Zener voltage range ⁽¹⁾ at I _Z =5mA V _Z (Volts)	
	Min.	Max.
BZV55-B2V4	2.35	2.45
BZV55-B2V7	2.65	2.75
BZV55-B3V0	2.94	3.06
BZV55-B3V3	3.23	3.37
BZV55-B3V6	3.53	3.67
BZV55-B3V9	3.82	3.98
BZV55-B4V3	4.21	4.39
BZV55-B4V7	4.61	4.79
BZV55-B5V1	5.00	5.20
BZV55-B5V6	5.49	5.71
BZV55-B6V2	6.08	6.32
BZV55-B6V8	6.66	6.94
BZV55-B7V5	7.35	7.65
BZV55-B8V2	8.04	8.36
BZV55-B9V1	8.92	9.28
BZV55-B10	9.80	10.20
BZV55-B11	10.80	11.20
BZV55-B12	11.80	12.20
BZV55-B13	12.70	13.30
BZV55-B15	14.70	15.30
BZV55-B16	15.70	16.30
BZV55-B18	17.60	18.40
BZV55-B20	19.60	20.40
BZV55-B22	21.60	22.40
BZV55-B24	23.50	24.50
BZV55-B27	26.50	27.50 ⁽³⁾
BZV55-B30	29.40	30.60 ⁽³⁾
BZV55-B33	32.30	33.70 ⁽³⁾
BZV55-B36	35.30	36.70 ⁽³⁾
BZV55-B39	38.20	39.80 ⁽³⁾
BZV55-B43	42.10	43.90 ⁽³⁾
BZV55-B47	46.10	47.90 ⁽³⁾
BZV55-B51	50.00	52.00 ⁽³⁾
BZV55-B56	54.90	57.10 ⁽³⁾
BZV55-B62	60.80	63.20 ⁽³⁾
BZV55-B68	66.60	69.40 ⁽³⁾
BZV55-B75	73.50	76.50 ⁽³⁾

- Notes:**
1. Tested with pulses t_p=5ms
 2. Valid provided that electrodes are kept at ambient temperature
 3. at I_Z=2.0 mA

RATINGS AND CHARACTERISTIC CURVES

($T_A = 25^\circ\text{C}$ unless otherwise noted)

Breakdown characteristics

at $T_j = \text{constant}$ (pulsed)

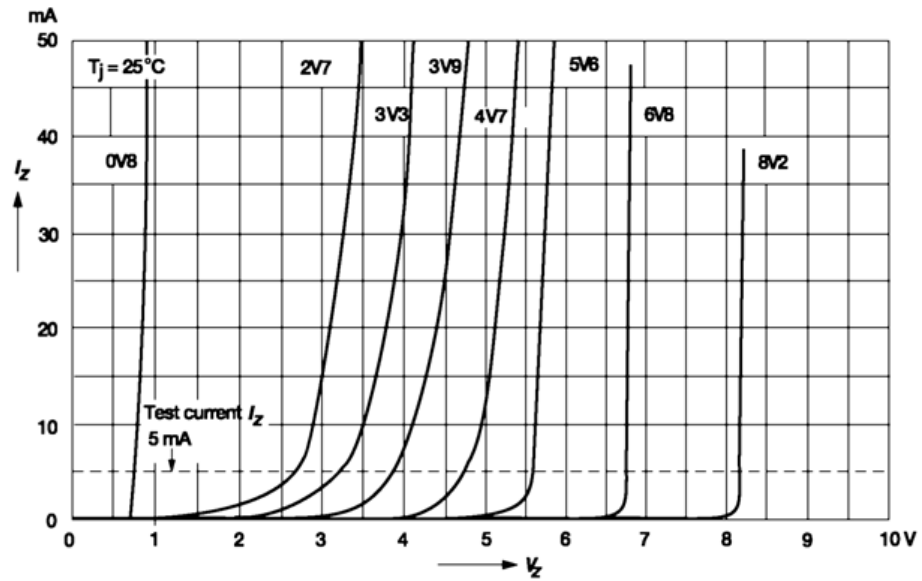

Breakdown characteristics

at $T_j = \text{constant}$ (pulsed)

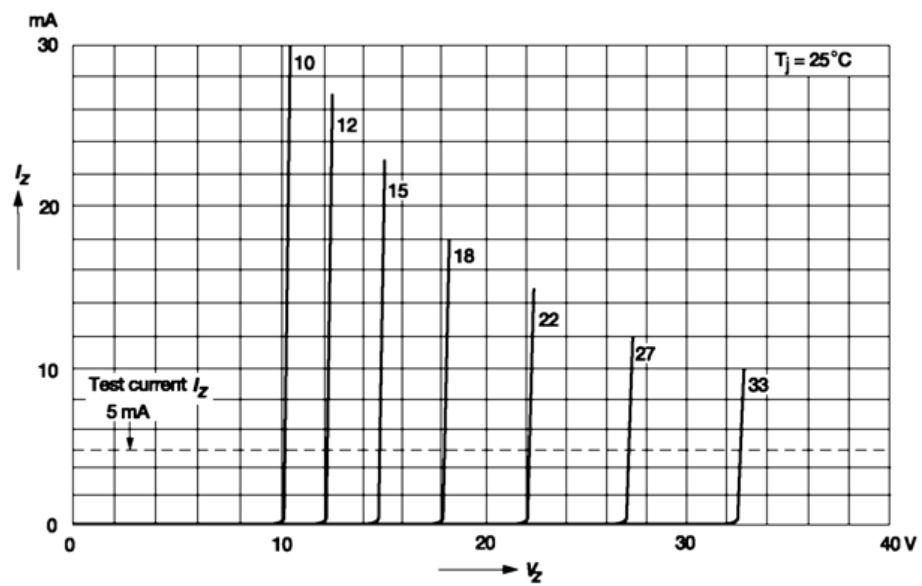

RATINGS AND CHARACTERISTIC CURVES

($T_A = 25^\circ\text{C}$ unless otherwise noted)

Admissible power dissipation versus ambient temperature

Valid provided that leads are kept ambient temperature.

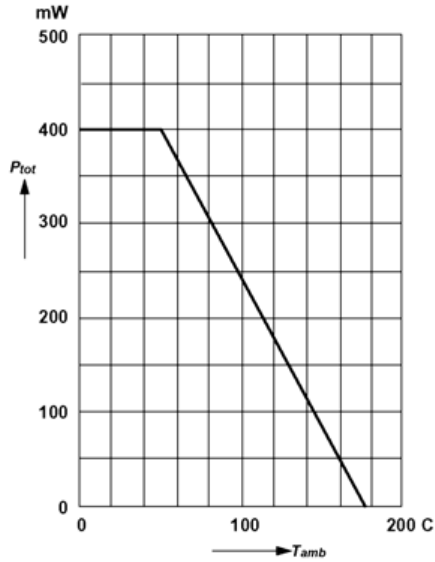

Capacitance versus Zener voltage

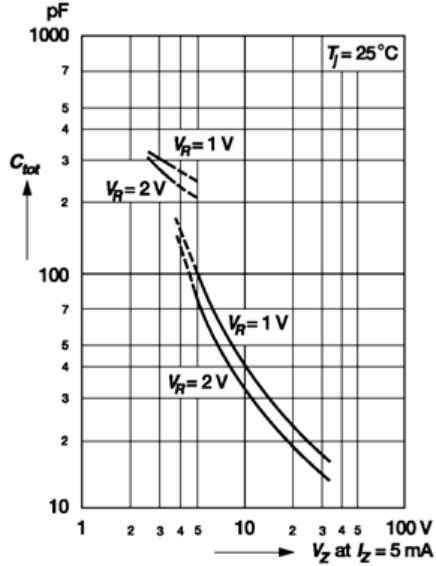

Pulse thermal resistance versus pulse duration

Valid provided that leads are kept at ambient temperature at a distance of 8 mm from case.

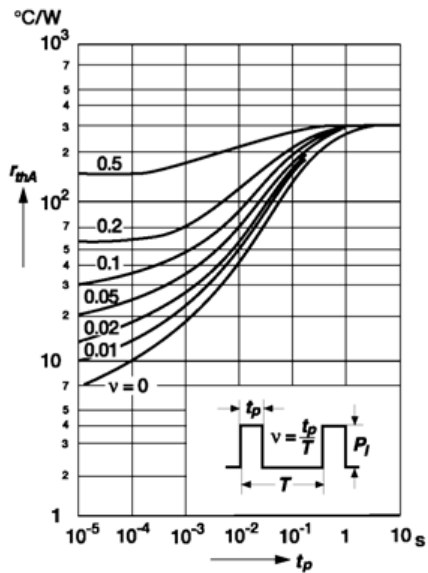

Dynamic resistance versus Zener current

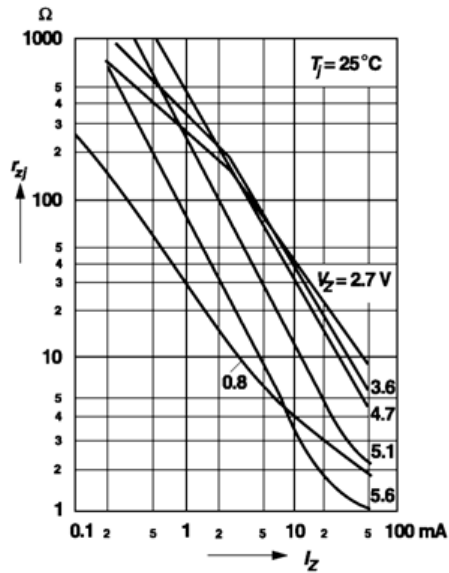

RATINGS AND CHARACTERISTIC CURVES

($T_A = 25^\circ\text{C}$ unless otherwise noted)

Dynamic resistance versus Zener current

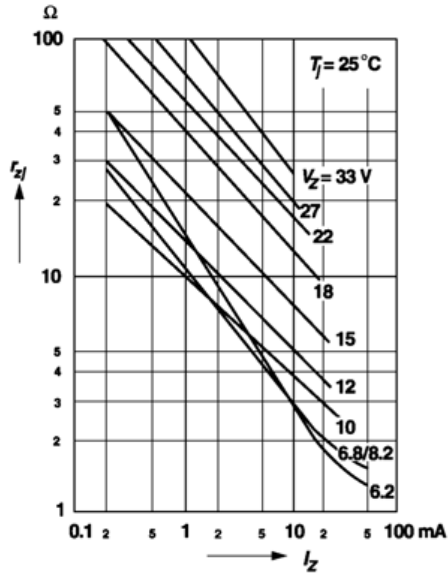

Thermal differential resistance versus Zener voltage

Valid provided that leads are kept at ambient temperature at a distance of 8 mm from case.

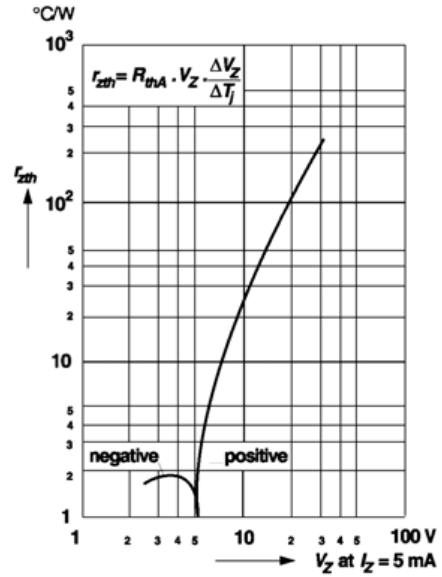

Dynamic resistance versus Zener voltage

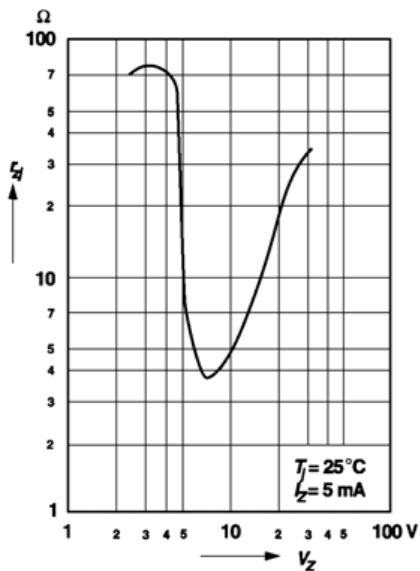

Thermal resistance versus lead length

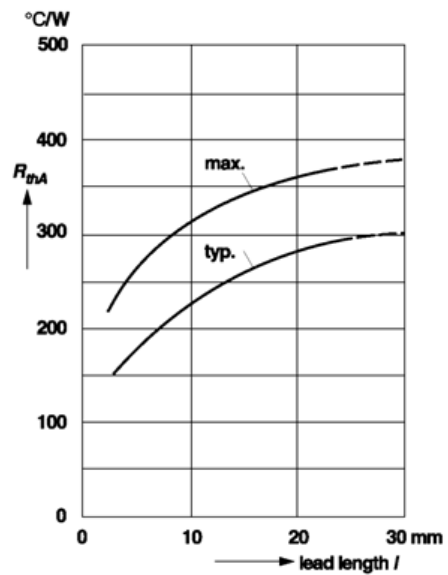

RATINGS AND CHARACTERISTIC CURVES

($T_A = 25^\circ\text{C}$ unless otherwise noted)

Temperature dependence of Zener voltage versus Zener voltage

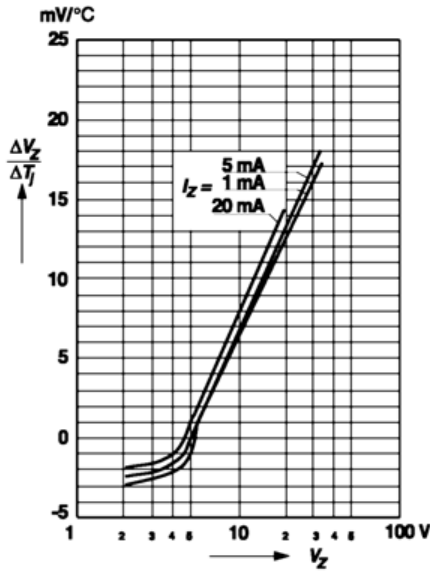

Change of Zener voltage from turn-on up to the point of thermal equilibrium versus Zener voltage

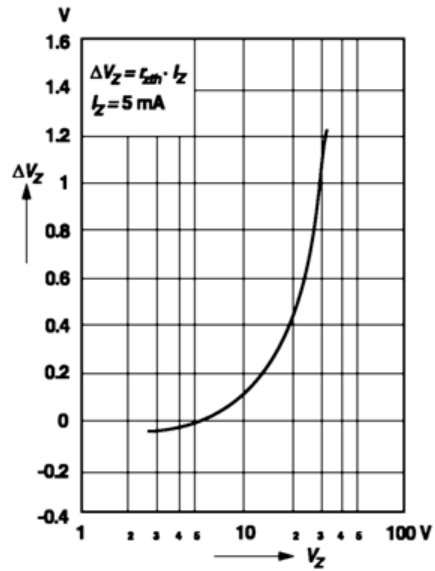

Change of Zener voltage versus junction temperature

