

1 Form A Solid State Relay (Low Capacitance)

Features

- Low Capacitance Switch (5.0 pF)
- Isolation Test Voltage 5300 V_{RMS}
- Extremely High OFF-resistance (100 GΩ)
- Load Voltage 200 V
- Clean Bounce Free Switching
- Low Power Consumption
- High Reliability Monolithic Receptor
- Lead (Pb)-free component
- Component in accordance to RoHS 2002/95/EC and WEEE 2002/96/EC



RoHS
COMPLIANT

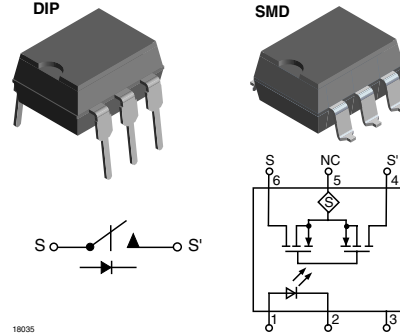

Agency Approvals

- UL1577, File No. E52744 System Code H or J, Double Protection
- CSA - Certification 093751
- BSI/BABT Cert. No. 7980
- DIN EN 60747-5-2 (VDE0884)
DIN EN 60747-5-5 pending
- FIMKO Approval

Applications

- Instrumentation
 - Thermocouple Switching
 - Analog Multiplexing
- Reed Relay Replacement
- Programmable Logic Controllers
- Data Acquisition
- Test Equipment

Description

These SSRs (LH1541, 1 Form A) are SPST normally open switches which can replace electromechanical relays in many applications. The relays provide a low capacitance, high-voltage switch contact with high off resistance and low switch-offset voltage. These characteristics, combined with high-speed actuation, result an SSR which is ideal for small signal and dc instrumentation applications.

The relays are constructed by using a GaAlAs LED for actuation control and an integrated monolithic die for the switch output. The die is comprised of a photodiode array, switch-control circuitry, and low-capacitance MOSFET switches.

Order Information

Part	Remarks
LH1541AAB1	Tubes, SMD-6
LH1541AAB1TR	Tape and Reel, SMD-6
LH1541AT1	Tubes, DIP-6

Absolute Maximum Ratings

T_{amb} = 25 °C, unless otherwise specified

Stresses in excess of the absolute Maximum Ratings can cause permanent damage to the device. Functional operation of the device is not implied at these or any other conditions in excess of those given in the operational sections of this document. Exposure to absolute Maximum Ratings for extended periods of time can adversely affect reliability.

SSR

Parameter	Test condition	Symbol	Value	Unit
LED continuous forward current		I _F	50	mA
LED reverse voltage	I _R ≤ 10 μA	V _R	8.0	V
DC or peak AC load voltage	I _L ≤ 50 μA	V _L	200	V

Parameter	Test condition	Symbol	Value	Unit
Continuous DC load current - bidirectional operation		I_L	55	mA
Peak load current (single shot)	$t = 100 \text{ ms}$	I_p	100	mA
Ambient temperature range		T_{amb}	- 40 to + 85	°C
Storage temperature range		T_{stg}	- 40 to + 150	°C
Pin soldering temperature	$t = 10 \text{ s max}$	T_{sld}	260	°C
Input/output isolation voltage		V_{ISO}	5300	V_{RMS}
Output power dissipation (continuous)		P_{diss}	550	mW

Electrical Characteristics

$T_{amb} = 25 \text{ °C}$, unless otherwise specified

Minimum and maximum values are testing requirements. Typical values are characteristics of the device and are the result of engineering evaluations. Typical values are for information only and are not part of the testing requirements.

Input

Parameter	Test condition	Symbol	Min	Typ.	Max	Unit
LED forward current, switch turn-on	$I_L = 100 \text{ mA}$, $t = 10 \text{ ms}$	I_{Fon}		0.6	2.0	mA
LED forward current, switch turn-off	$V_L = \pm 150 \text{ V}$	I_{Foff}	0.1	0.5		mA
LED forward voltage	$I_F = 5 \text{ mA}$	V_F	1.10	1.26	1.45	V

Output

Parameter	Test condition	Symbol	Min	Typ.	Max	Unit
ON-resistance ac/dc: Pin 4(±) to 6 (±)	$I_F = 5.0 \text{ mA}$, $I_L = 50 \text{ mA}$	R_{ON}	70	110	160	Ω
Off-resistance	$I_F = 0 \text{ mA}$, $V_L = \pm 100 \text{ V}$	R_{OFF}	0.5	10000		G Ω
Off-state leakage current	$I_F = 0 \text{ mA}$, $V_L = \pm 100 \text{ V}$	I_O		0.4	200	nA
	$I_F = 0 \text{ mA}$, $V_L = \pm 200 \text{ V}$	I_O			1.0	μA
Output capacitance Pin 4 to 6	$I_F = 0 \text{ mA}$, $V_L = 1.0 \text{ V}$	C_O		4.8		pF
	$I_F = 0 \text{ mA}$, $V_L = 50 \text{ V}$	C_O		36		pF
Switch offset	$I_F = 5.0 \text{ mA}$	V_{OS}		0.15		μV

Transfer

Parameter	Test condition	Symbol	Min	Typ.	Max	Unit
Capacitance (input-output)	$V_{ISO} = 1.0 \text{ V}$	C_{IO}		0.8		pF
Turn-on time	$I_F = 5.0 \text{ mA}$, $I_L = 50 \text{ mA}$	t_{on}		0.2	0.5	ms
Turn-off time	$I_F = 5.0 \text{ mA}$, $I_L = 50 \text{ mA}$	t_{off}		0.3	0.5	ms

Typical Characteristics

$T_{amb} = 25\text{ }^{\circ}\text{C}$, unless otherwise specified

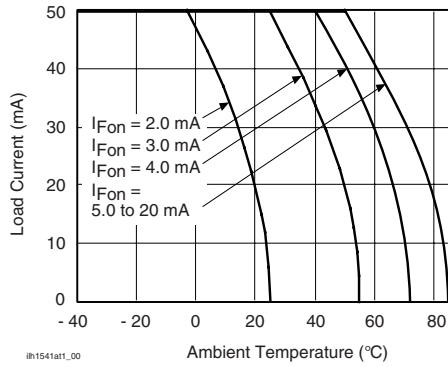

Figure 1. Recommended Operating Conditions

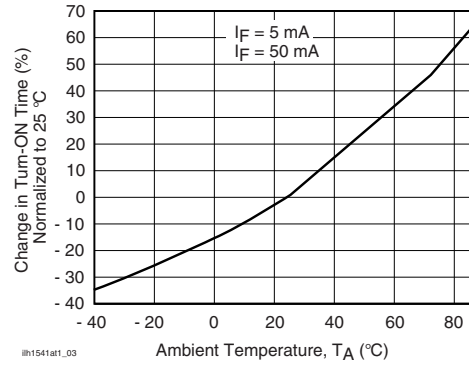

Figure 4. LED Dropout Voltage vs. Temperature

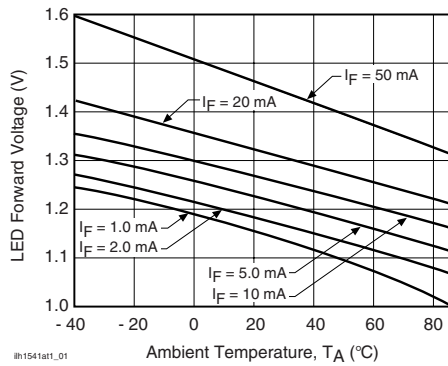

Figure 2. LED Voltage vs. Temperature

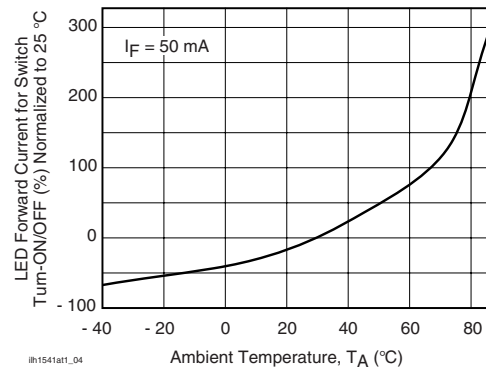

Figure 5. LED Current for Switch Turn-on vs. Temperature

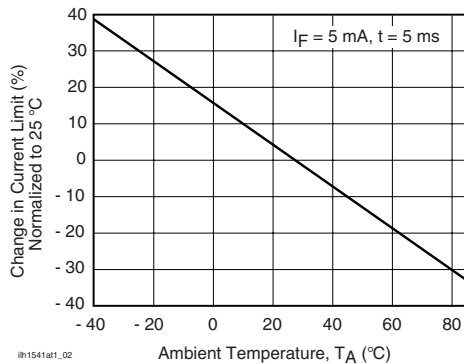

Figure 3. Current Limit vs. Temperature

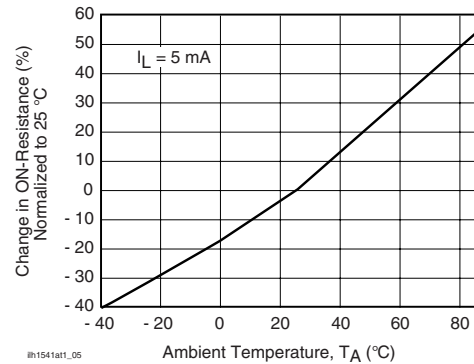

Figure 6. ON-Resistance vs. Temperature

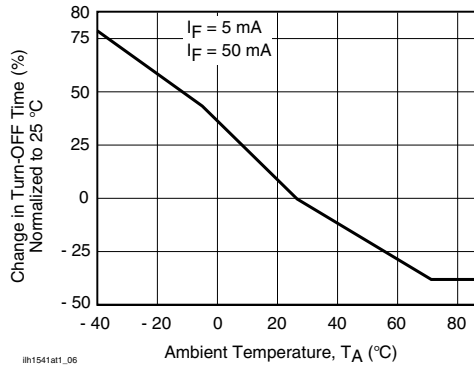

Figure 7. Switch Capacitance vs. Applied Voltage

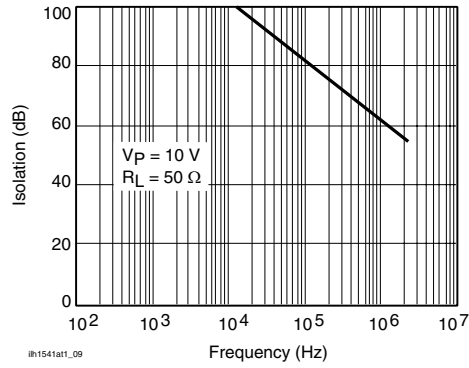

Figure 10. Output Isolation

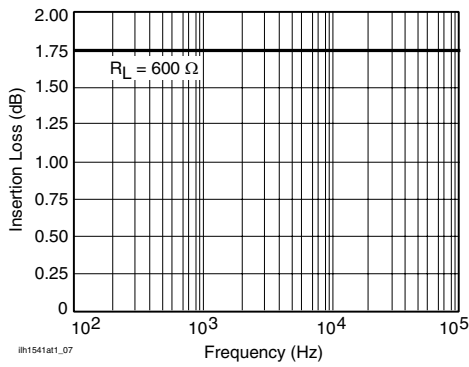

Figure 8. Insertion Loss vs. Frequency

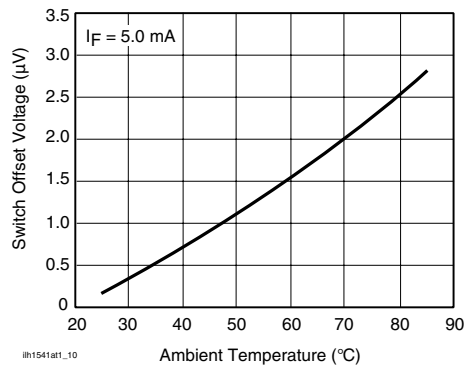

Figure 11. Switch Offset Voltage vs. Temperature

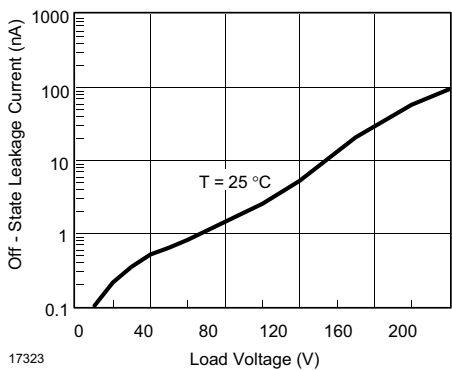

Figure 9. Leakage Current vs. Applied Voltage

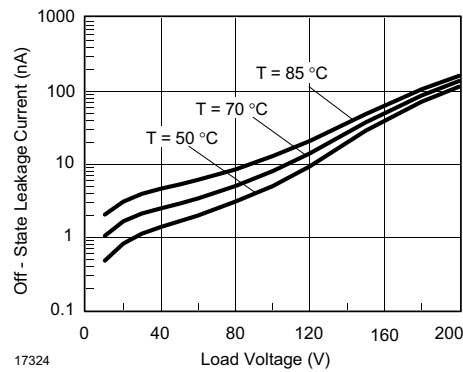

Figure 12. Leakage Current vs. Applied Voltage at Elevated Temperatures

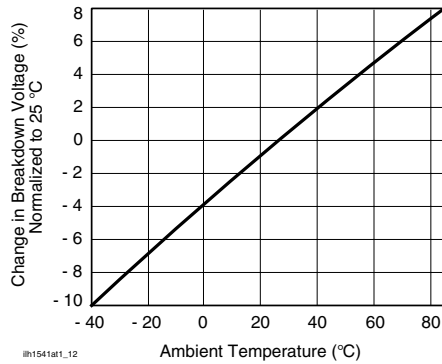

Figure 13. Switch Breakdown Voltage vs. Temperature

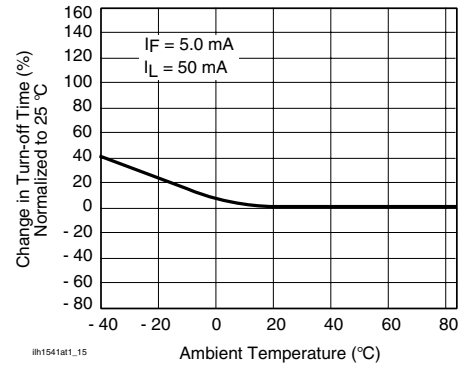

Figure 16. Turn-off Time vs. Temperature

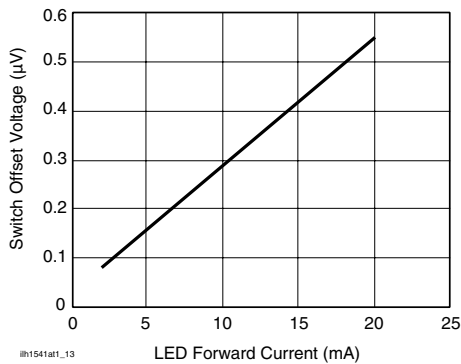

Figure 14. Switch Offset Voltage vs. LED Current

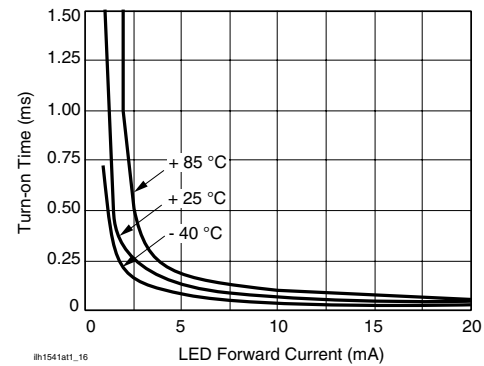

Figure 17. Turn-on Time vs. LED Current

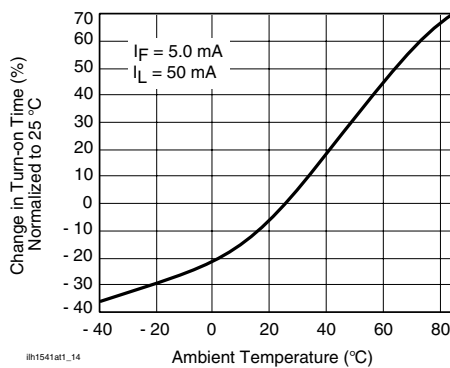

Figure 15. Turn-on Time vs. Temperature

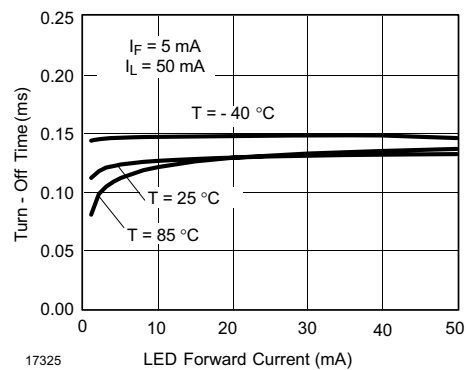

Figure 18. Turn-off Time vs. LED Current

LH1541AAB1/ AAB1TR/ AT1



Vishay Semiconductors

Package Dimensions in Inches (mm)

DIP

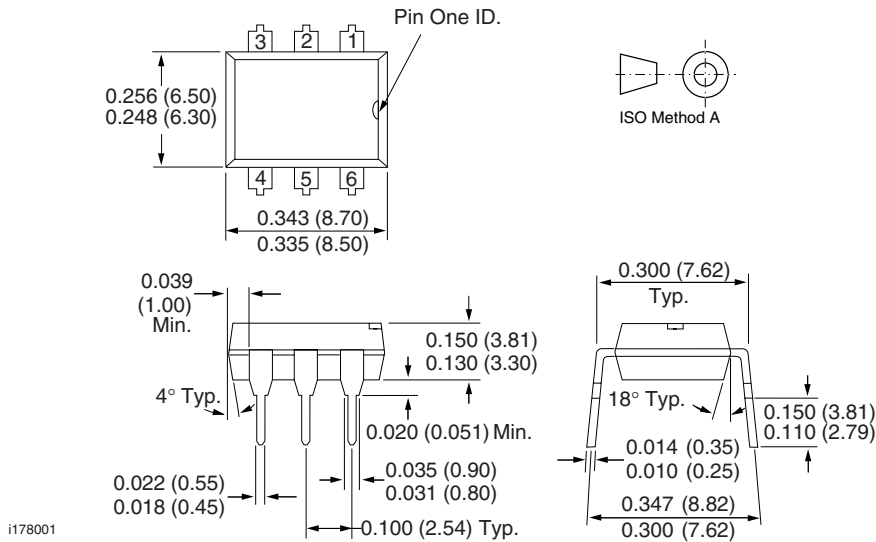

Package Dimensions in Inches (mm)

SMD

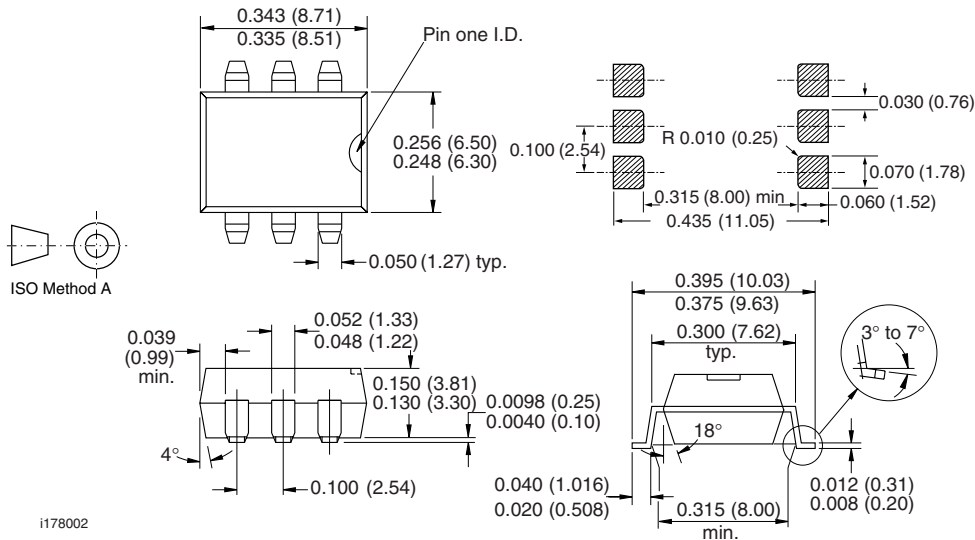



Ozone Depleting Substances Policy Statement

It is the policy of Vishay Semiconductor GmbH to

1. Meet all present and future national and international statutory requirements.
2. Regularly and continuously improve the performance of our products, processes, distribution and operating systems with respect to their impact on the health and safety of our employees and the public, as well as their impact on the environment.

It is particular concern to control or eliminate releases of those substances into the atmosphere which are known as ozone depleting substances (ODSs).

The Montreal Protocol (1987) and its London Amendments (1990) intend to severely restrict the use of ODSs and forbid their use within the next ten years. Various national and international initiatives are pressing for an earlier ban on these substances.

Vishay Semiconductor GmbH has been able to use its policy of continuous improvements to eliminate the use of ODSs listed in the following documents.

1. Annex A, B and list of transitional substances of the Montreal Protocol and the London Amendments respectively
2. Class I and II ozone depleting substances in the Clean Air Act Amendments of 1990 by the Environmental Protection Agency (EPA) in the USA
3. Council Decision 88/540/EEC and 91/690/EEC Annex A, B and C (transitional substances) respectively.

Vishay Semiconductor GmbH can certify that our semiconductors are not manufactured with ozone depleting substances and do not contain such substances.

We reserve the right to make changes to improve technical design and may do so without further notice.

Parameters can vary in different applications. All operating parameters must be validated for each customer application by the customer. Should the buyer use Vishay Semiconductors products for any unintended or unauthorized application, the buyer shall indemnify Vishay Semiconductors against all claims, costs, damages, and expenses, arising out of, directly or indirectly, any claim of personal damage, injury or death associated with such unintended or unauthorized use.

Vishay Semiconductor GmbH, P.O.B. 3535, D-74025 Heilbronn, Germany



Notice

Specifications of the products displayed herein are subject to change without notice. Vishay Intertechnology, Inc., or anyone on its behalf, assumes no responsibility or liability for any errors or inaccuracies.

Information contained herein is intended to provide a product description only. No license, express or implied, by estoppel or otherwise, to any intellectual property rights is granted by this document. Except as provided in Vishay's terms and conditions of sale for such products, Vishay assumes no liability whatsoever, and disclaims any express or implied warranty, relating to sale and/or use of Vishay products including liability or warranties relating to fitness for a particular purpose, merchantability, or infringement of any patent, copyright, or other intellectual property right.

The products shown herein are not designed for use in medical, life-saving, or life-sustaining applications. Customers using or selling these products for use in such applications do so at their own risk and agree to fully indemnify Vishay for any damages resulting from such improper use or sale.