

150mA Dual LDO REGULATOR

NO.EA-089-071105

OUTLINE

The R5323x Series are CMOS-based voltage regulator ICs with high output voltage accuracy, low supply current, low dropout, and high ripple rejection. Each of these voltage regulator ICs consists of a voltage reference unit, an error amplifier, resistors for setting Output Voltage, a current limit circuit, and a chip enable circuit.

These ICs perform with low dropout voltage due to built-in transistor with low ON resistance, and a chip enable function prolongs the battery life of each system. The line transient response and load transient response of the R5323x Series are excellent, thus these ICs are very suitable for the power supply for hand-held communication equipment.

The output voltage of these ICs is internally fixed with high accuracy. Since the packages for these ICs are SOT-23-6, DFN(PLP)1820-6 and WLCSP-6-P1 package, dual LDO regulators are included in each package, high density mounting of the ICs on boards is possible.

FEATURES

- Supply Current Typ. 90 μ A (VR1, VR2)
- Standby Mode Typ. 0.1 μ A (VR1, VR2)
- Dropout Voltage Typ. 0.22V ($I_{OUT}=150\text{mA}$, $V_{OUT}=3.0\text{V}$)
- Ripple Rejection Typ.75dB($V_{OUT} \leq 2.4\text{V}$),Typ.70dB($V_{OUT} \leq 2.5\text{V}$), (f=1kHz)
Typ.65dB($V_{OUT} \leq 2.4\text{V}$),Typ.60dB($V_{OUT} \leq 2.5\text{V}$), (f=10kHz)
- Temperature-drift Coefficient of Output Voltage..... Typ. $\pm 100\text{ppm}/^\circ\text{C}$
- Line Regulation Typ.0.02%/V
- Output Voltage Accuracy..... $\pm 2.0\%$
- Packages SOT-23-6, DFN(PLP)1820-6, WLCSP-6-P1
- Output Voltage Stepwise setting with a step of 0.1V in the range of 1.5V to 4.0V is possible
- Built-in chip enable circuit (A/B: active high)
- Built-in fold-back protection circuit Typ. 40mA (Current at short mode)
- Ceramic Capacitor is recommended. (1.0 μ F or more)

APPLICATIONS

- Power source for handheld communication equipment.
- Power source for electrical appliances such as cameras, VCRs and camcorders.
- Power source for battery-powered equipment.

BLOCK DIAGRAMS

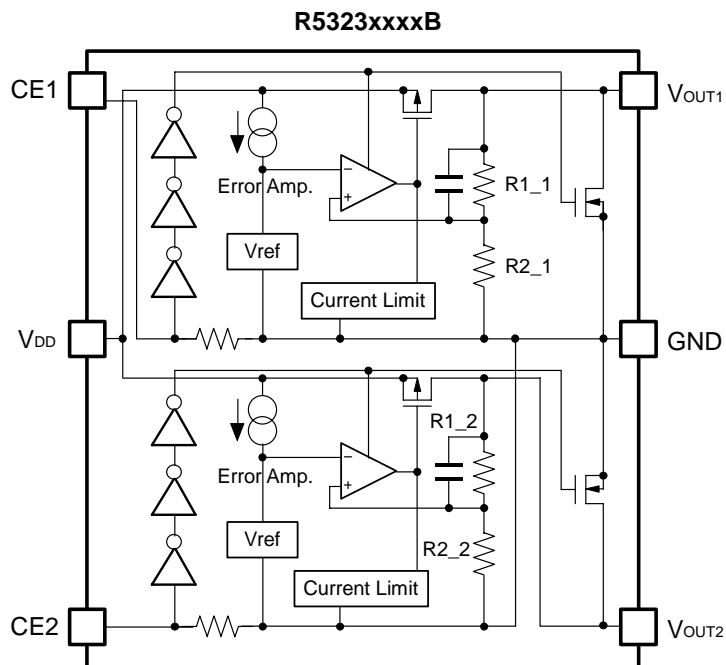
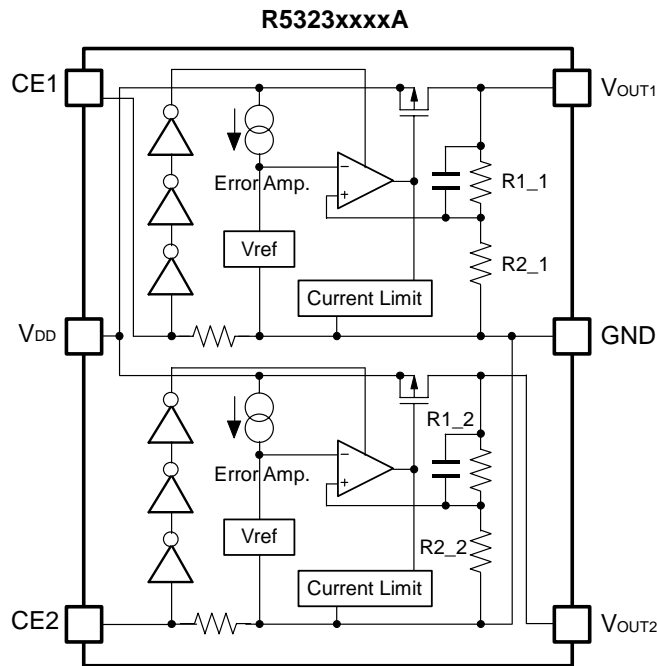

SELECTION GUIDE

The output voltage, mask option, and the taping type for the ICs can be selected at the user's request.
The selection can be made with designating the part number as shown below;

R5323xxxxx-xx-X ←Part Number
 ↑ ↑ ↑ ↑ ↑
 a b c d e

Code	Contents
a	Designation of Package Type: N : SOT-23-6 K : DFN(PLP)1820-6 Z : WLCSP-6-P1
b	Setting combination of dual Output Voltage (V_{OUT}) : Serial Number for Voltage Setting, Stepwise setting with a step of 0.1V in the range of 1.5V to 4.0V is possible for each channel.
c	Designation of Mask Option: A version: without auto discharge function* at OFF state. B version: with auto discharge function* at OFF state.
d	Designation of Taping Type: Ex. TR (refer to Taping Specifications; TR type is the standard direction.)
e	Designation of composition of plating: -F : Lead free plating (SOT-23-5, WLCSP-6-P1) None : Au plating (DFN(PLP)1820-6)

*) When the mode is into standby with CE signal, auto discharge transistor turns on, and it makes the turn-off speed faster than normal type.

PIN CONFIGURATION

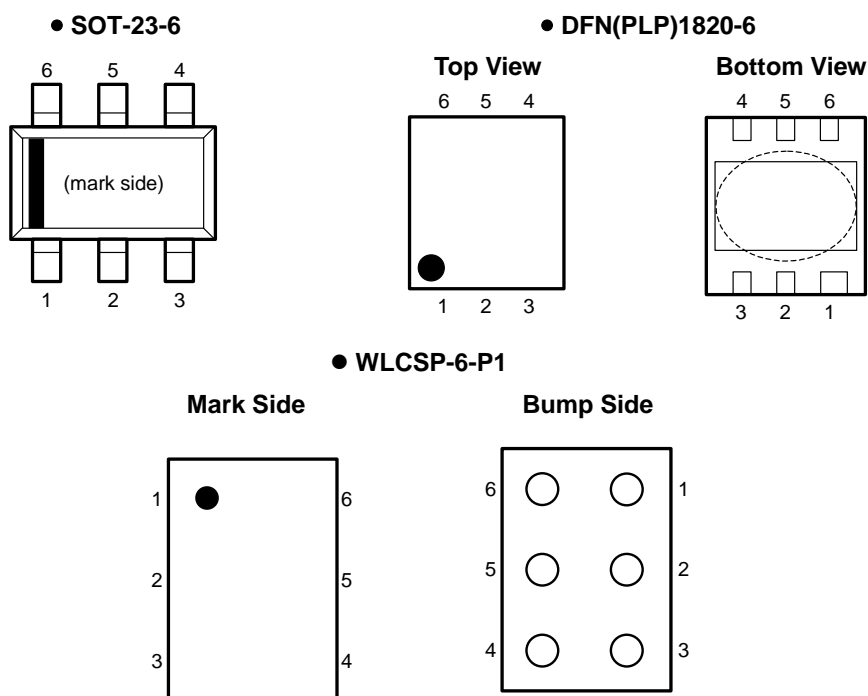

PIN DESCRIPTIONS

• SOT-23-6

Pin No.	Symbol	Description
1	V_{OUT1}	Output Pin 1
2	V_{DD}	Input Pin
3	V_{OUT2}	Output Pin 2
4	CE2	Chip Enable Pin 2
5	GND	Ground Pin
6	CE1	Chip Enable Pin 1

DFN(PLP)1820-6

Pin No.	Symbol	Description
1	V_{OUT2}	Output Pin 2
2	V_{DD}	Input Pin
3	V_{OUT1}	Output Pin 1
4	GND	Ground Pin
5	CE1	Chip Enable Pin 1
6	CE2	Chip Enable Pin 2

• WLCSP-6-P1

Pin No.	Symbol	Description
1	V_{OUT1}	Output Pin 1
2	V_{DD}	Input Pin
3	V_{OUT2}	Output Pin 2
4	CE2	Chip Enable Pin 2
5	GND	Ground Pin
6	CE1	Chip Enable Pin 1

*) Tab in the  parts have GND level.
 (They are connected to the back side of this IC.)
 Do not connect to other wires or land patterns.

ABSOLUTE MAXIMUM RATINGS

Symbol	Item	Rating	Unit
V_{IN}	Input Voltage	6.5	V
V_{CE}	Input Voltage (CE Pin)	-0.3 to 6.5	V
V_{OUT}	Output Voltage	-0.3 to $V_{IN} + 0.3$	V
I_{OUT1}	Output Current 1	200	mA
I_{OUT2}	Output Current 2	200	mA
P_D	Power Dissipation (SOT-23-6)*	420	mW
	Power Dissipation (DFN(PLP)1820-6) *	880	
	Power Dissipation (WLCSP-6-P1)	633	
T_{opt}	Operating Temperature Range	-40 to 85	°C
T_{stg}	Storage Temperature Range	-55 to 125	°C

*) For Power Dissipation, please refer to PACKAGE INFORMATION to be described.

ABSOLUTE MAXIMUM RATINGS

Absolute Maximum ratings are threshold limit values that must not be exceeded ever for an instant under any conditions. Moreover, such values for any two items must not be reached simultaneously. Operation above these absolute maximum ratings may cause degradation or permanent damage to the device. These are stress ratings only and do not necessarily imply functional operation below these limits.

ELECTRICAL CHARACTERISTICS

• R5323xxxxA/B

T_{opt}=25°C

Symbol	Item	Conditions	Min.	Typ.	Max.	Unit
V _{OUT}	Output voltage	V _{IN} =Set V _{OUT} +1V 1mA ≤ I _{OUT} ≤ 30mA	×0.98		×1.02	V
I _{OUT}	Output Current	V _{IN} -V _{OUT} = 1.0V	150			mA
ΔV _{OUT} /ΔI _{OUT}	Load regulation	V _{IN} =Set V _{OUT} +1V 1mA ≤ I _{OUT} ≤ 150mA		15	40	mV
V _{DIF}	Dropout Voltage	I _{OUT} =150mA	V _{OUT} =1.5	0.38	0.70	V
			V _{OUT} =1.6	0.35	0.65	
			V _{OUT} =1.7	0.33	0.60	
			1.8V ≤ V _{OUT} ≤ 2.0V	0.32	0.55	
			2.1V ≤ V _{OUT} ≤ 2.7V	0.28	0.50	
			2.8V ≤ V _{OUT} ≤ 4.0V	0.22	0.35	
I _{SS}	Supply Current	V _{IN} =Set V _{OUT} +1V		90	120	μA
I _{standby}	Standby Current	V _{IN} =Set V _{OUT} +1V V _{CE} =GND		0.1	1.0	μA
ΔV _{OUT} /ΔV _{IN}	Line regulation	Set V _{OUT} +0.5V ≤ V _{IN} ≤ 6.0V I _{OUT} =30mA		0.02	0.10	%/V
RR	Ripple Rejection	Ripple 0.5Vp-p V _{IN} =Set V _{OUT} +1V I _{OUT} =30mA (In case that V _{OUT} ≤ 1.7V, V _{IN} =Set V _{OUT} +1.2V)		75 *Note1 65 *Note2		dB
V _{IN}	Input Voltage		2.0		6.0	V
ΔV _{OUT} /ΔT _{opt}	Output Voltage Temperature Coefficient	I _{OUT} =30mA -40°C ≤ T _{opt} ≤ 85°C		±100		ppm/°C
I _{lim}	Short Current Limit	V _{OUT} =0V		40		mA
R _{PD}	Pull-down resistance for CE pin		0.7	2.0	8.0	MΩ
V _{CEH}	CE Input Voltage "H"		1.5		6.0	V
V _{CEL}	CE Input Voltage "L"		0		0.3	V
en	Output Noise	BW=10Hz to 100kHz		30		μVrms
R _{LOW}	Low Output Nch Tr. ON Resistance (of B version)	V _{CE} =0V		60		Ω

*Note1: f=1kHz, 70dB as to V_{OUT} ≥ 2.5V Output type.*Note2: f=10kHz, 60dB as to V_{OUT} ≥ 2.5V Output type.

TYPICAL APPLIATION

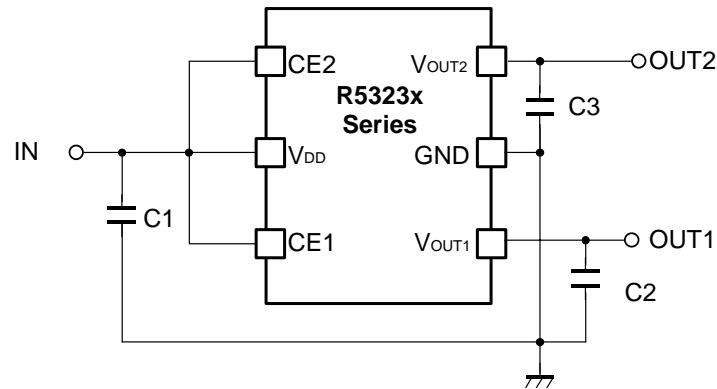

C1=C2=C3=Ceramic 1.0 μ F

TECHNICAL NOTES

When using these ICs, consider the following points:

Phase Compensation

In these ICs, phase compensation is made for securing stable operation even if the load current is varied. For this purpose, use a capacitor C2 and C3 with good frequency characteristics and ESR (Equivalent Series Resistance).

(Note: If additional ceramic capacitors are connected with parallel to the output pin with an output capacitor for phase compensation, the operation might be unstable. Because of this, test these ICs with as same external components as ones to be used on the PCB.)

PCB Layout

Make V_{DD} and GND lines sufficient. If their impedance is high, noise pickup or unstable operation may result. Connect a capacitor C1 with a capacitance value as much as 1.0 μ F or more between V_{DD} and GND pin, and as close as possible to the pins.

Set external components, especially the output capacitor C2 and C3, as close as possible to the ICs, and make wiring as short as possible.

TEST CIRCUIT

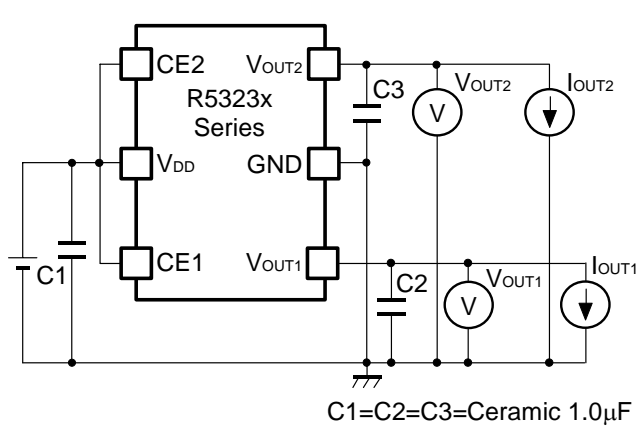

Fig.1 Standard test Circuit

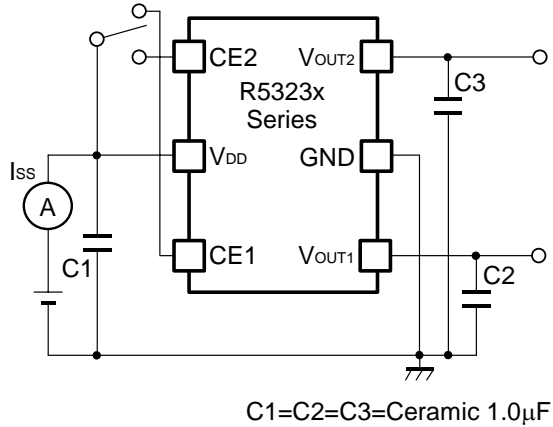

Fig.2 Supply Current Test Circuit

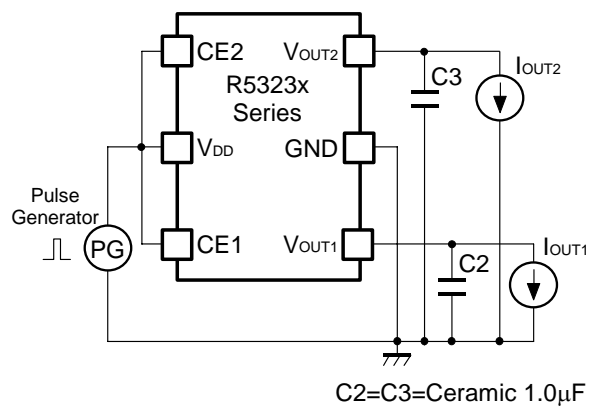

Fig.3 Ripple Rejection, Line Transient Response Test Circuit

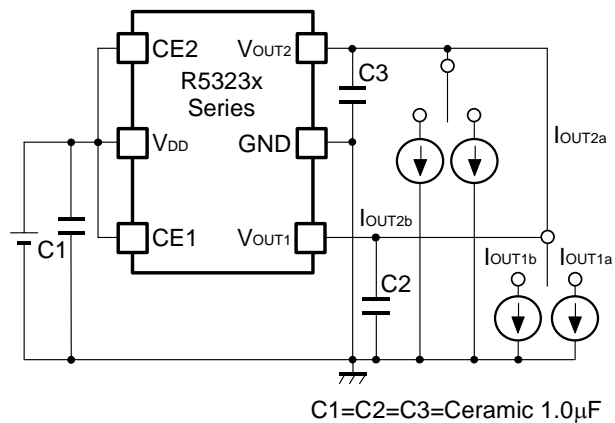
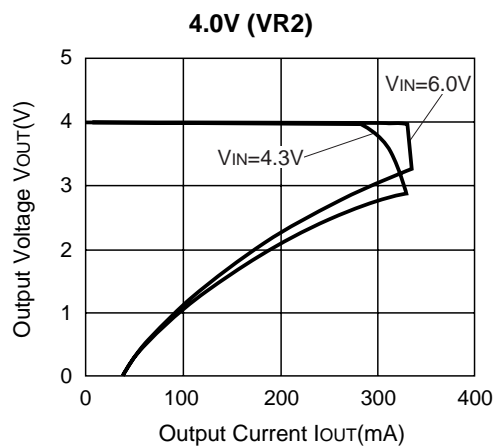
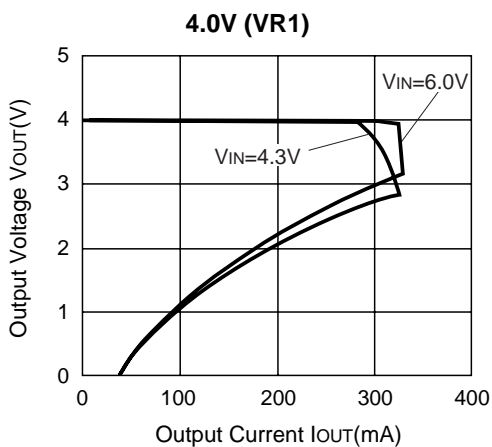
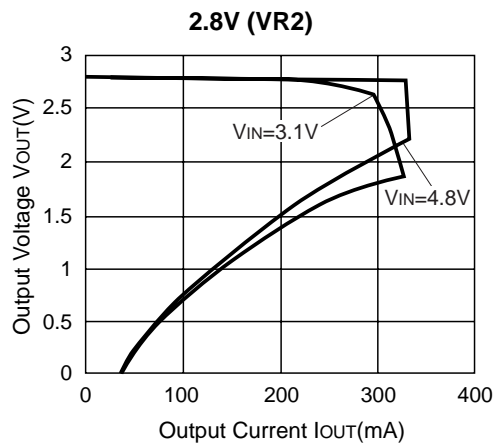
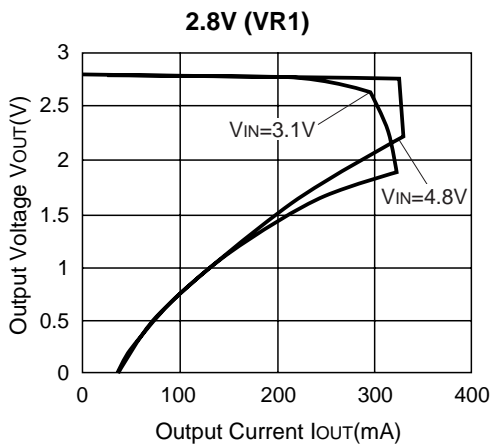
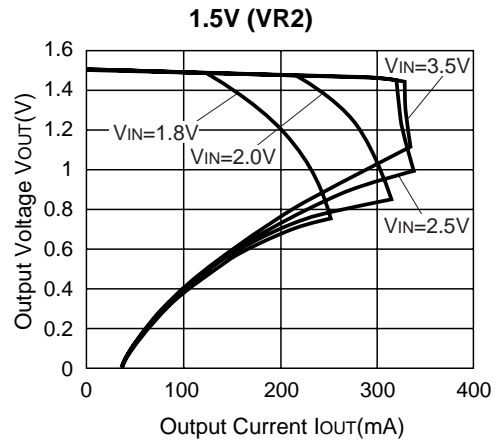
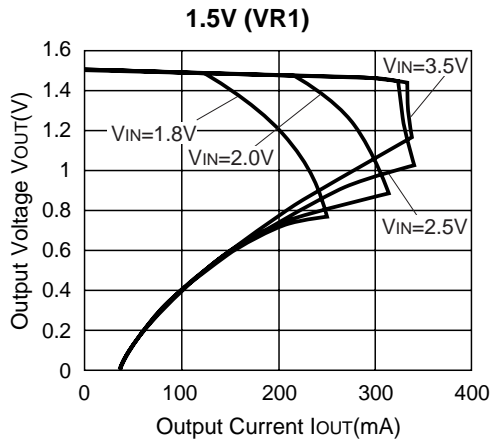

Fig.4 Load Transient Response Test Circuit

TYPICAL CHARACTERISTICS

1) Output Voltage vs. Output Current (Topt=25°C)



2) Output Voltage vs. Input Voltage (Topt=25°C)

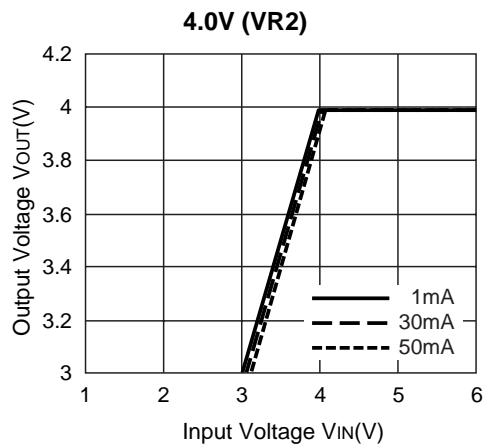
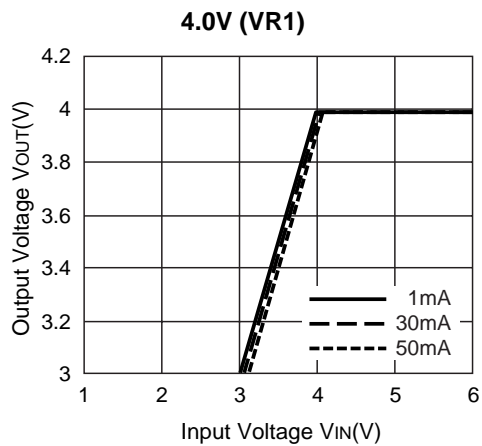
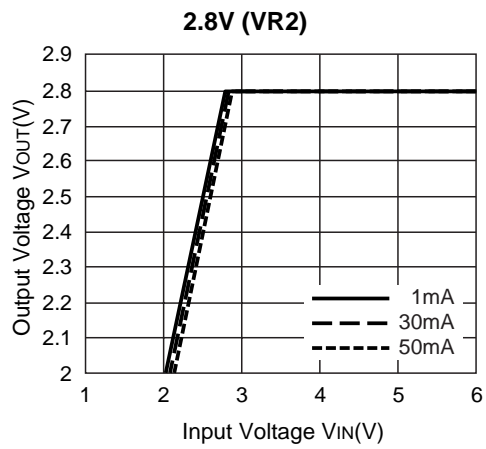
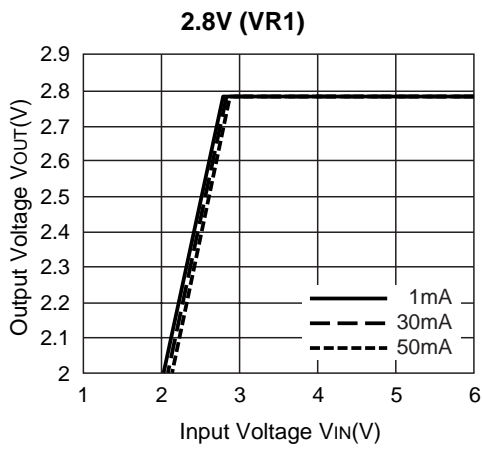
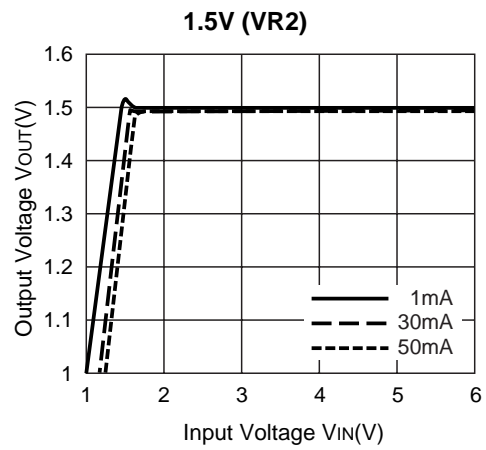
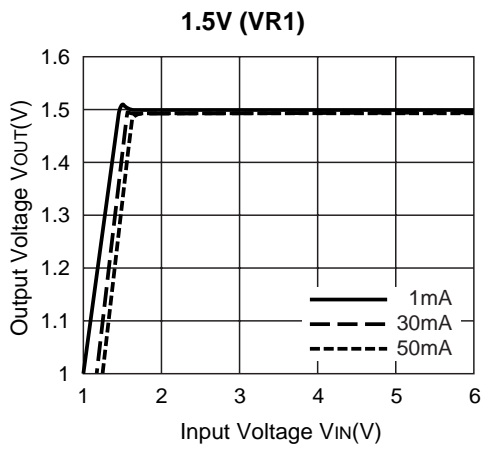

3) Dropout Voltage vs. Output Current

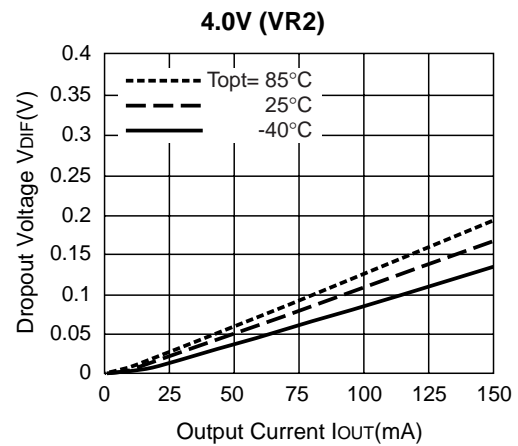
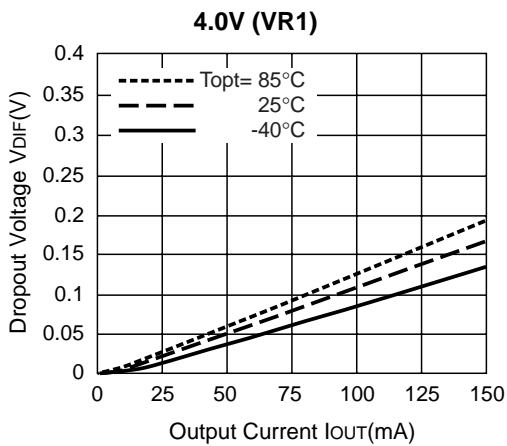
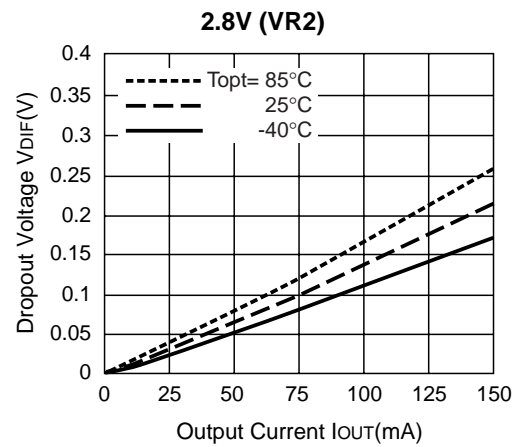
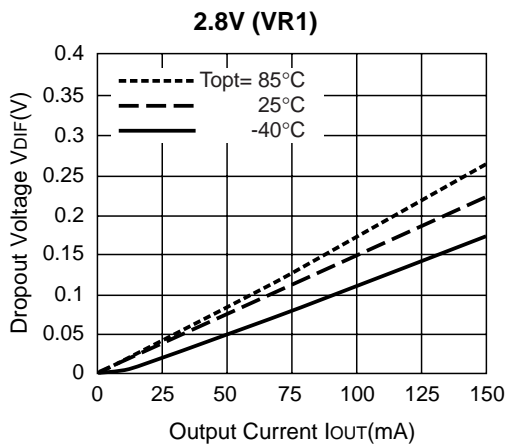
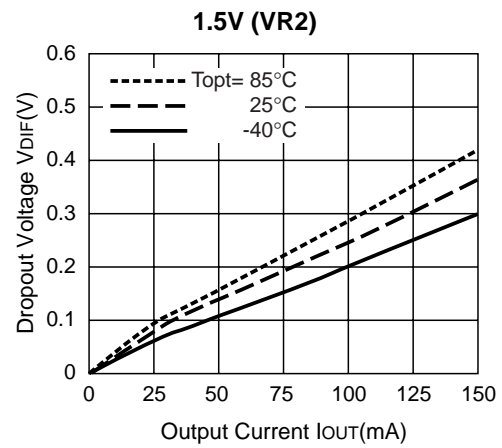
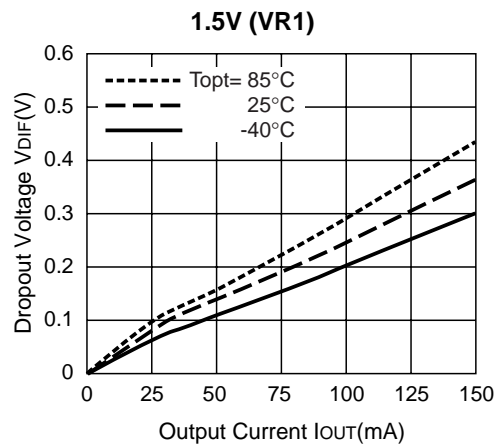

4) Output Voltage vs. Temperature

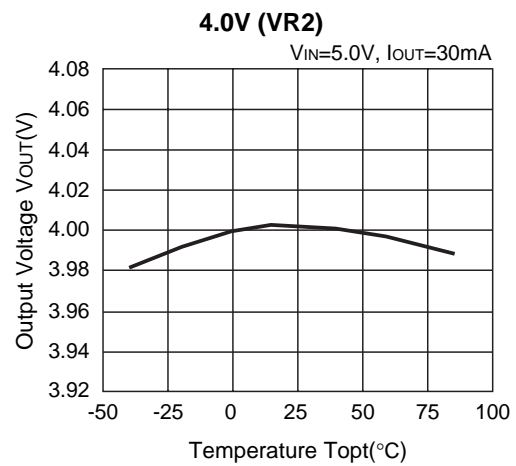
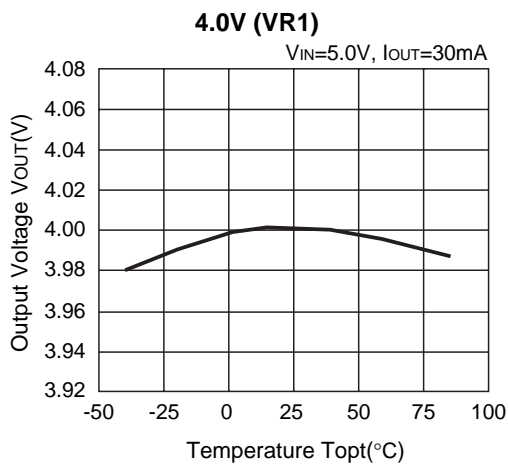
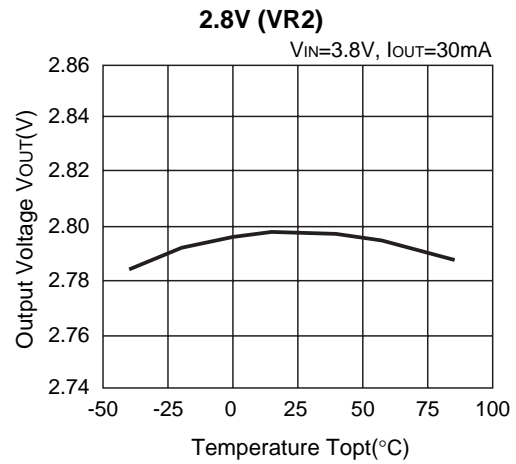
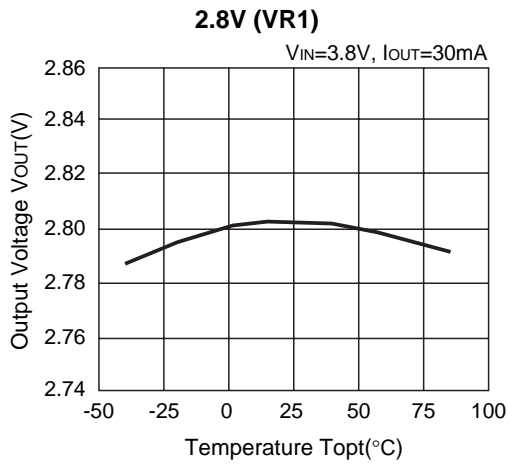
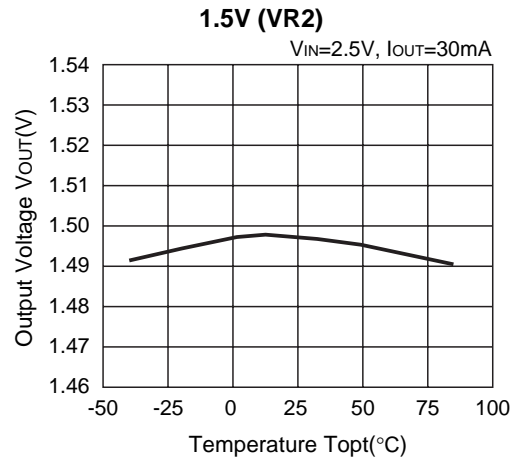
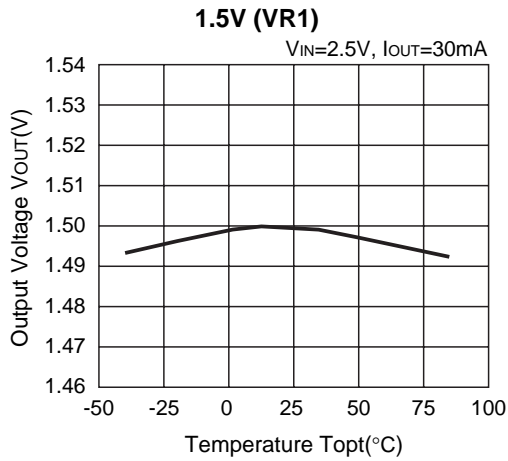

5) Supply Current vs. Input Voltage (T_{opt}=25°C)

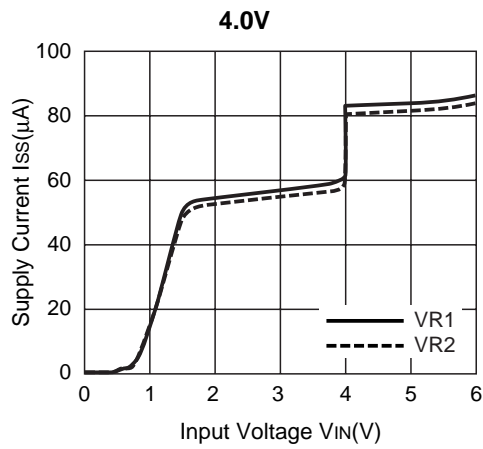
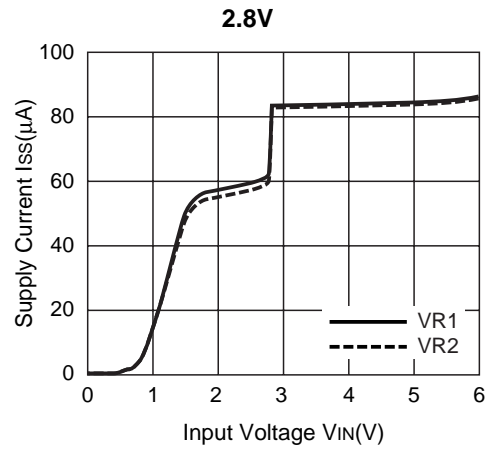
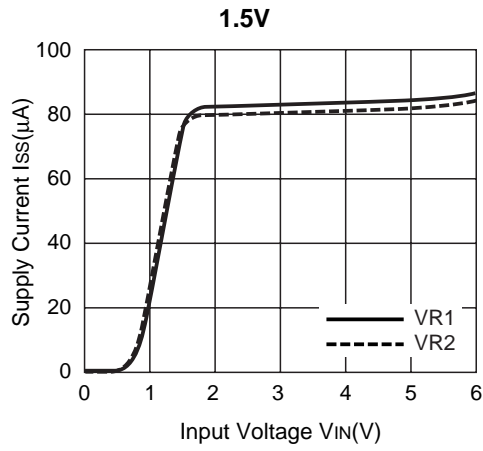

6) Supply Current vs. Temperature

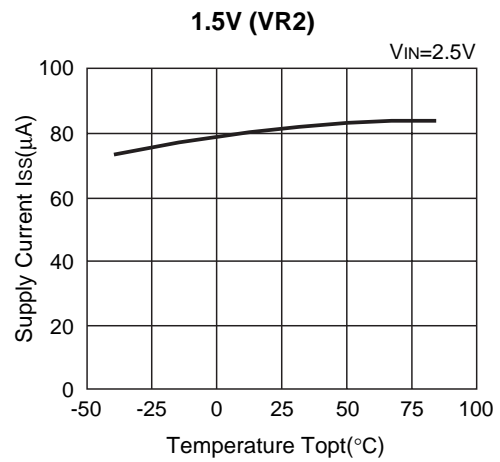
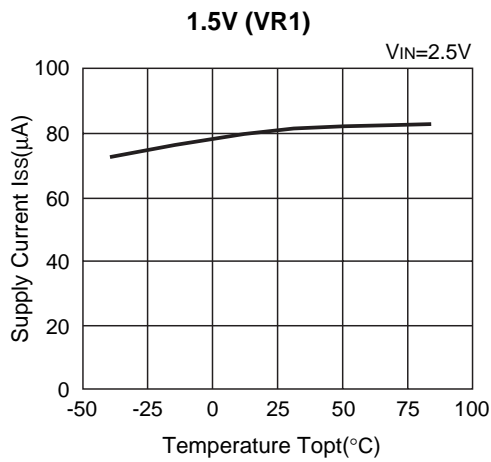

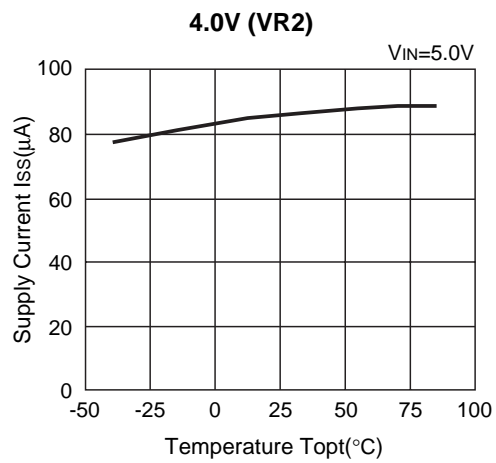
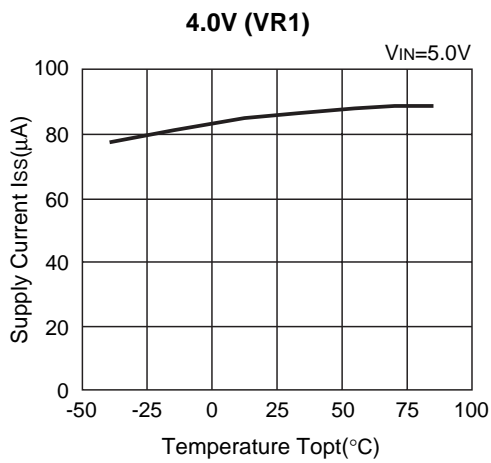
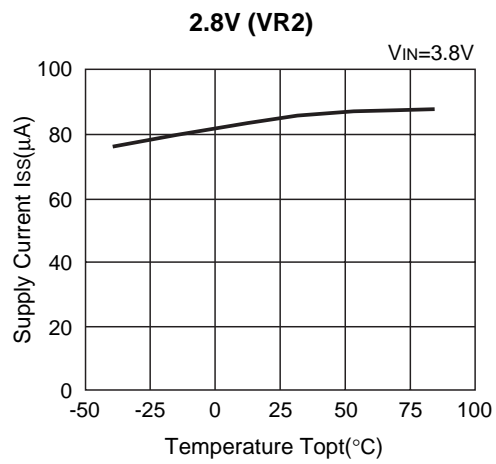
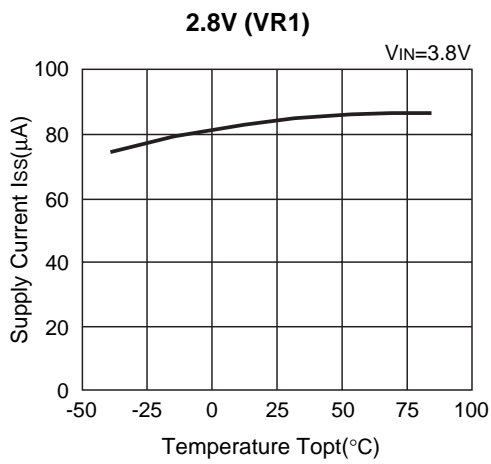

7) Dropout Voltage vs. Set Output Voltage (T_{opt}=25°C)

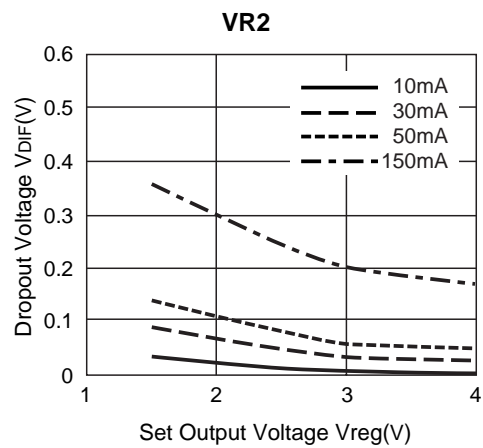
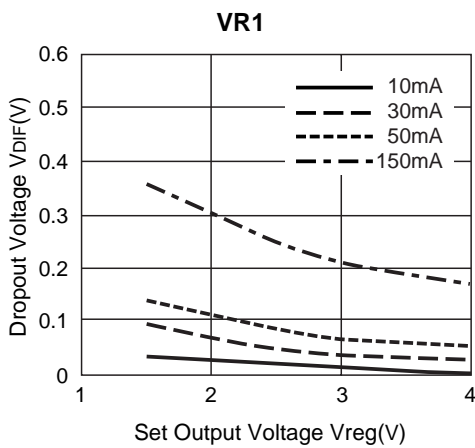

8) Ripple Rejection vs. Frequency (Topt=25°C)

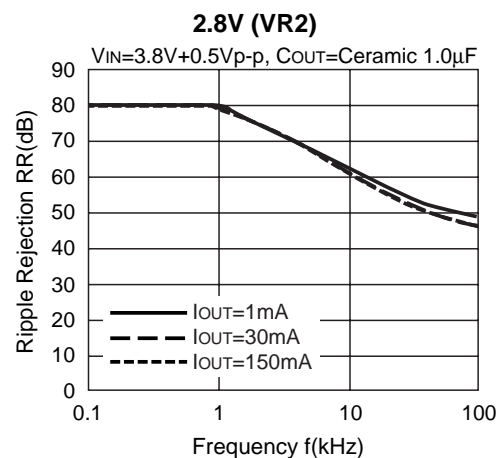
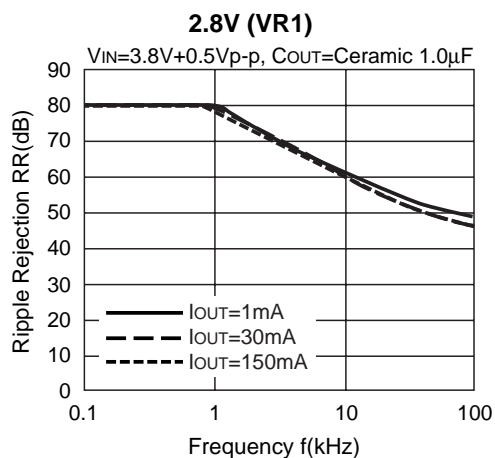
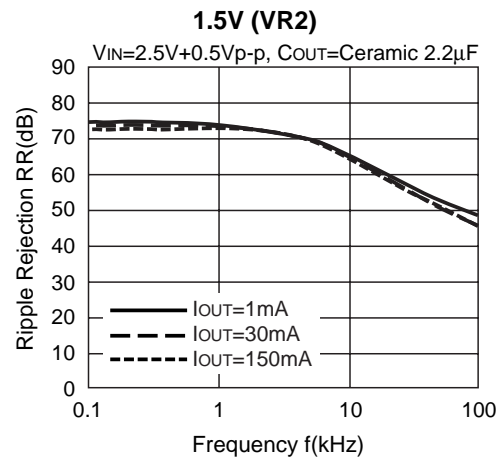
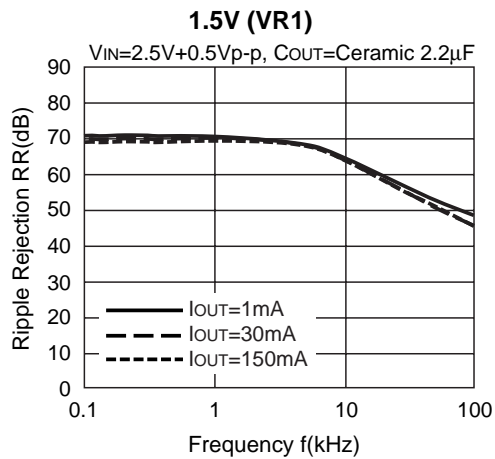
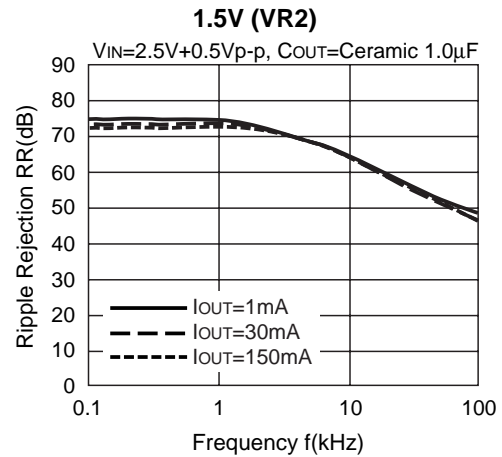
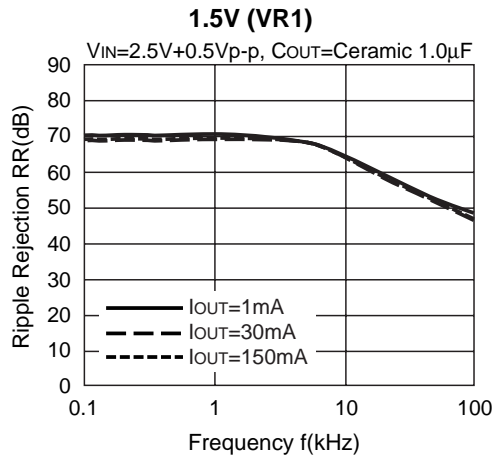

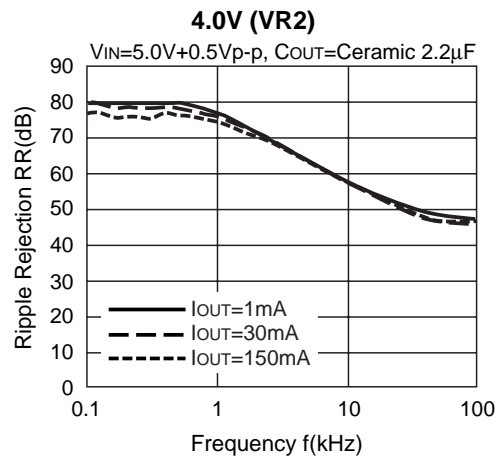
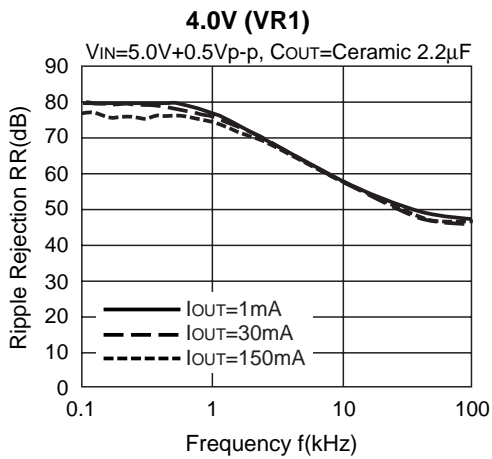
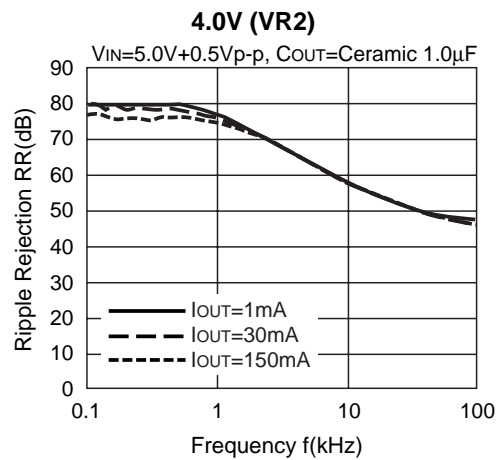
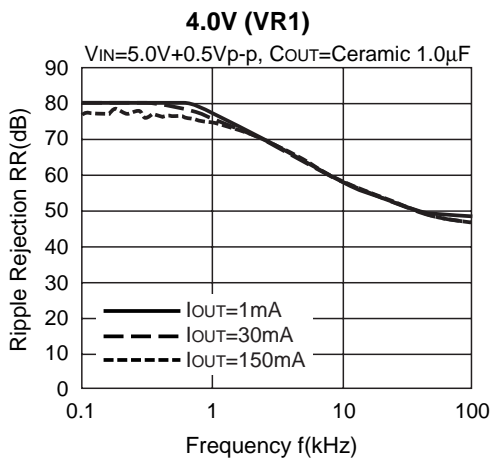
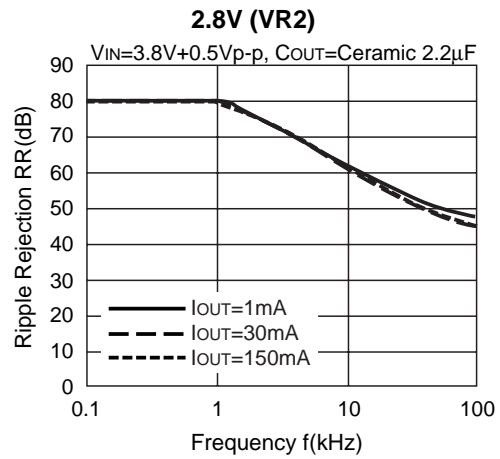
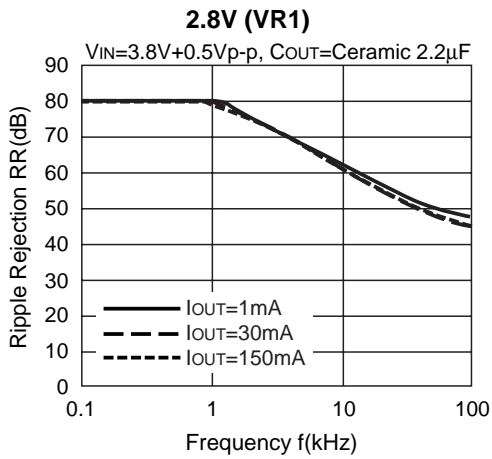

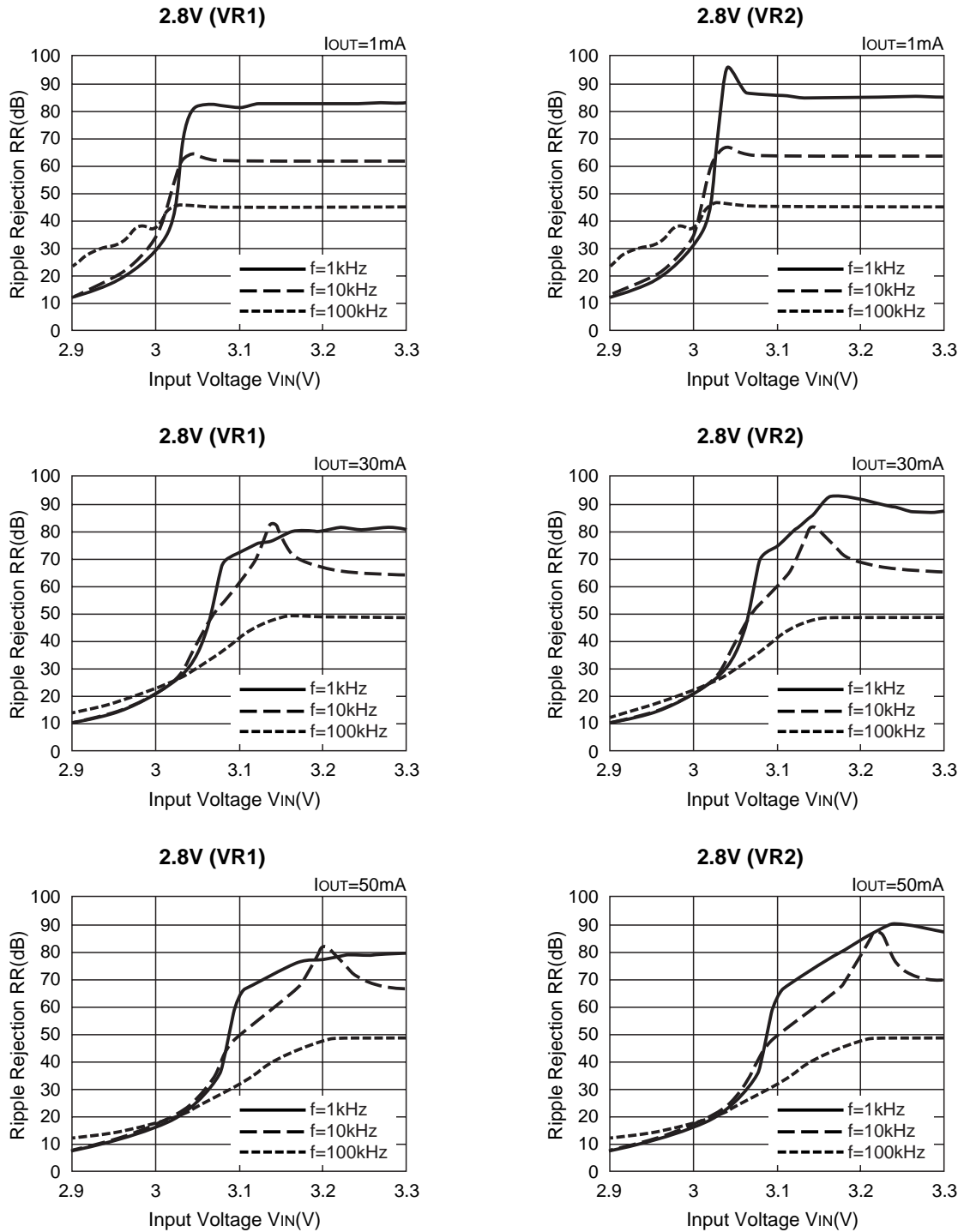
9) Ripple Rejection vs. Input Voltage (DC bias) (C_{OUT} =Ceramic $1.0\mu\text{F}$, $T_{opt}=25^\circ\text{C}$)

10) Input Transient Response ($I_{OUT}=30mA$, $t_r=t_f=5\mu s$)

R5323N001x(2.8V, VR1)

$I_{OUT}=30mA$, $t_r=t_f=5\mu s$, $C_{OUT}=\text{Ceramic } 1.0\mu F$

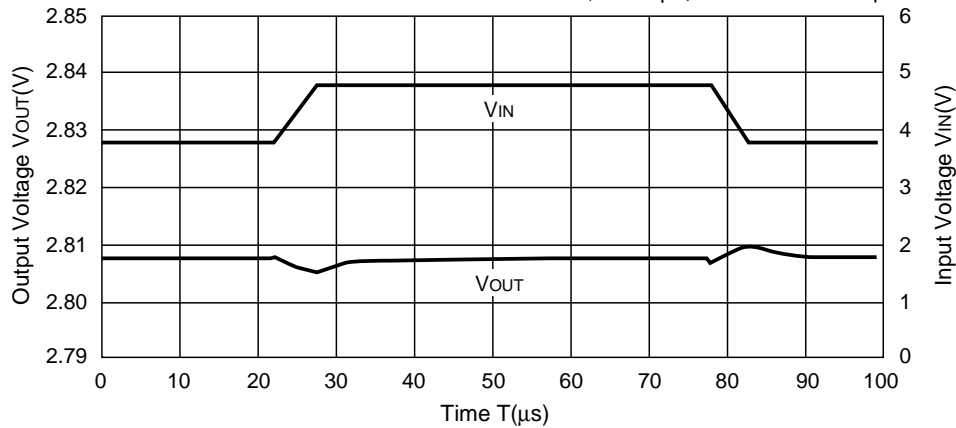

R5323N001x(2.8V, VR1)

$T_{opt}=25^{\circ}C$, $C_{OUT}=\text{Ceramic } 2.2\mu F$

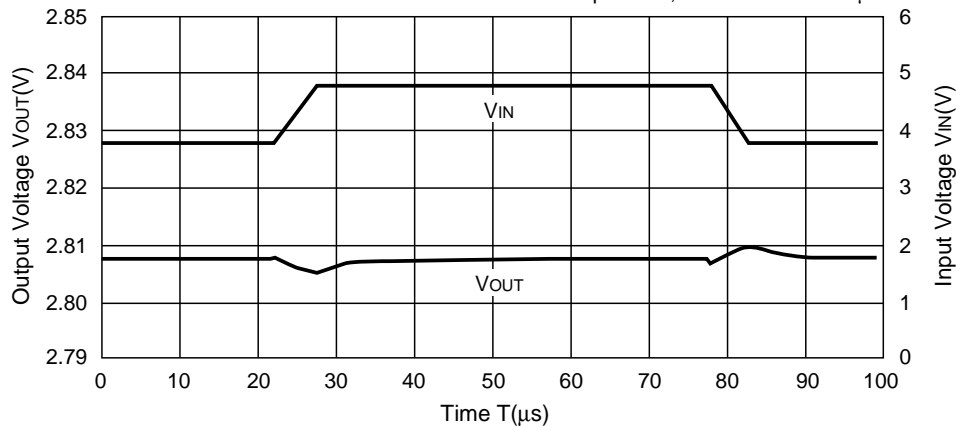

R5323N001x(2.8V, VR1)

$T_{opt}=25^{\circ}C$, $C_{OUT}=\text{Ceramic } 4.4\mu F$

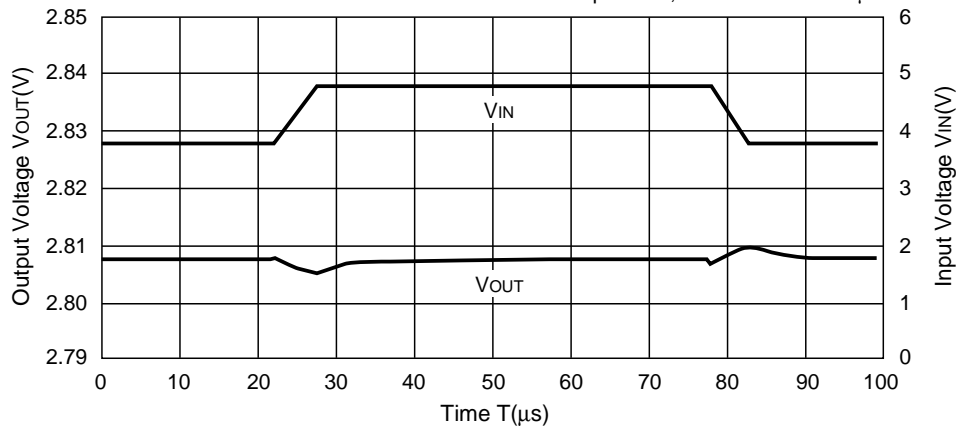

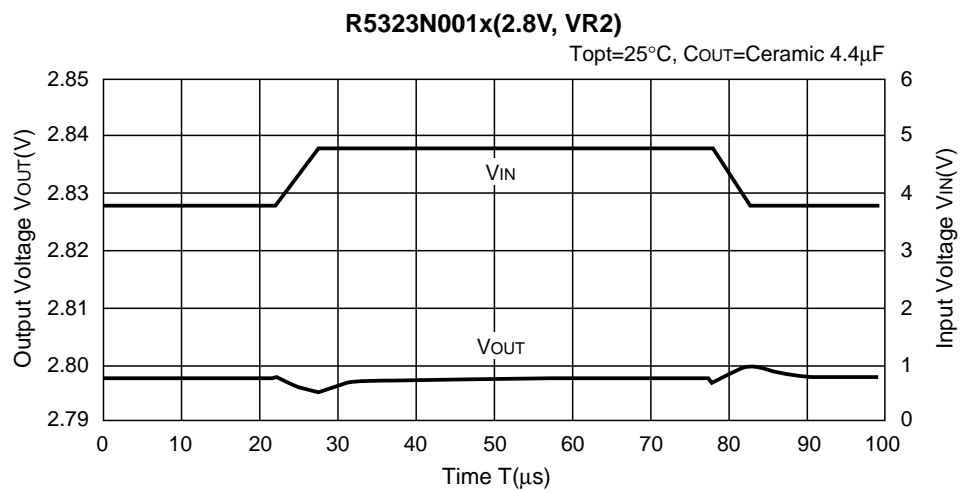
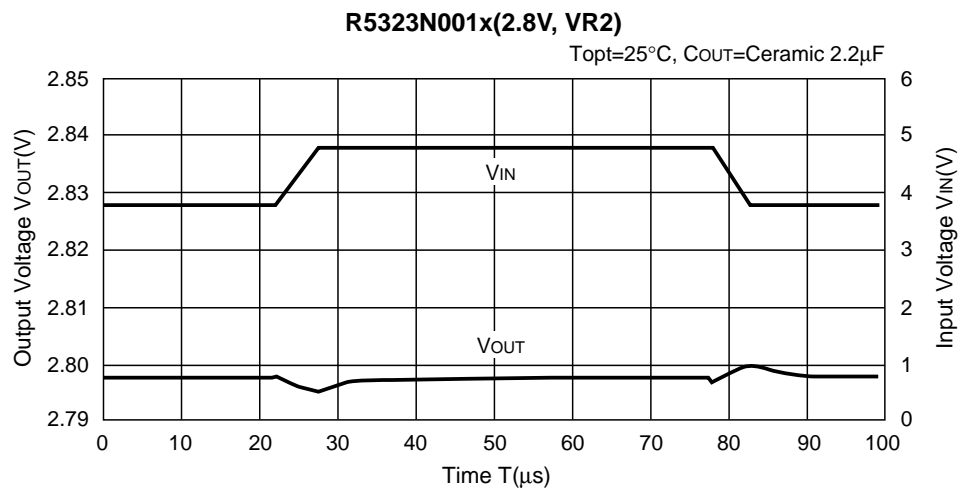
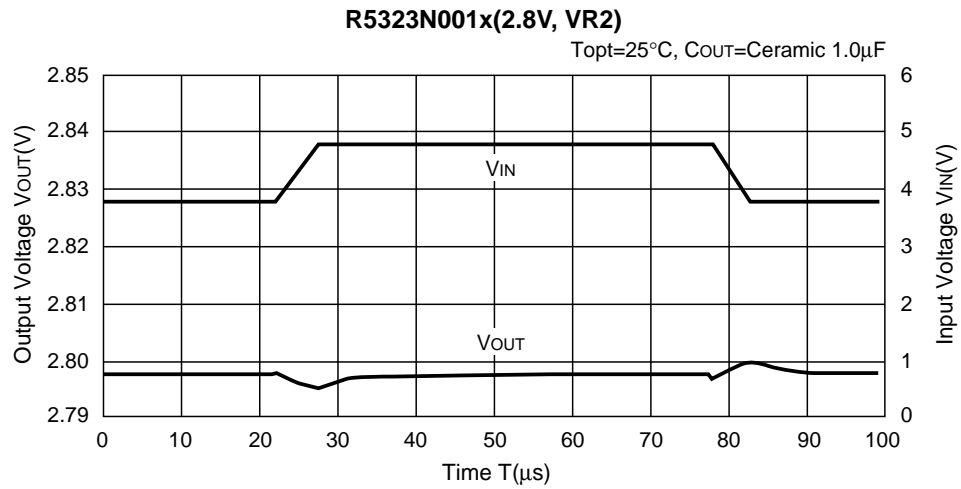

11) Load Transient Response

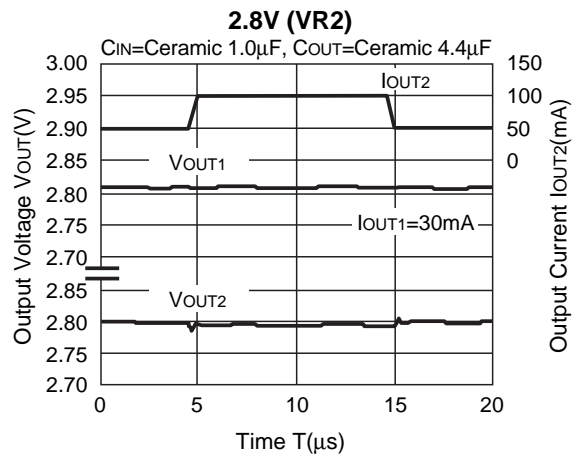
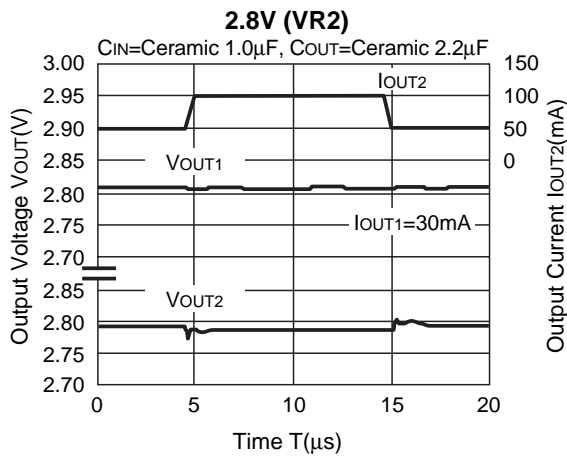
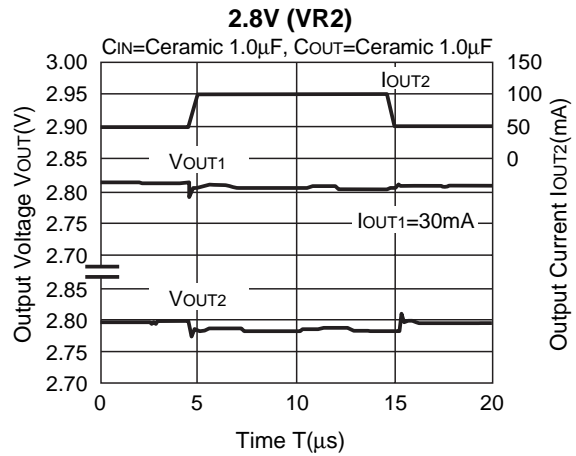
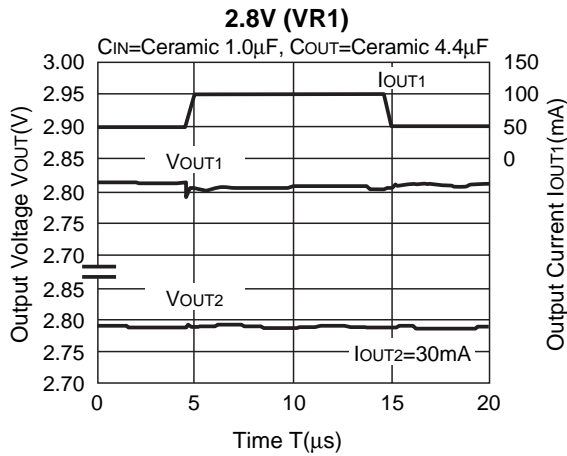
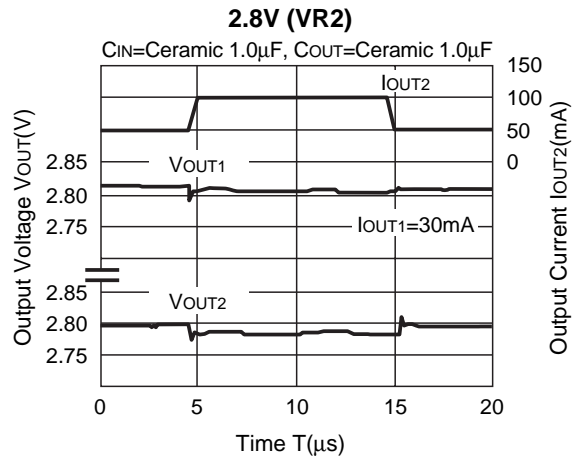
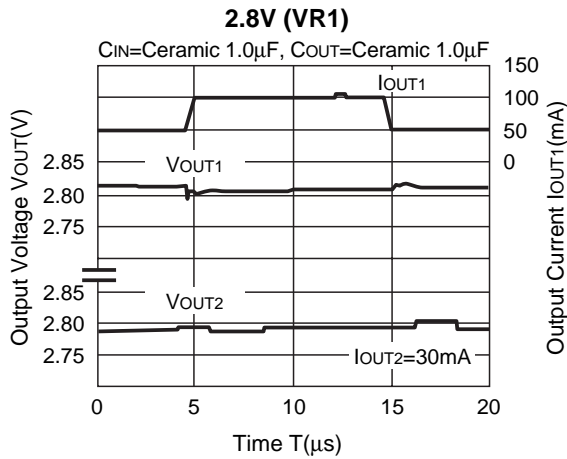

12) Minimum Operating Voltage

1.5V Minimum Operating Voltage Range

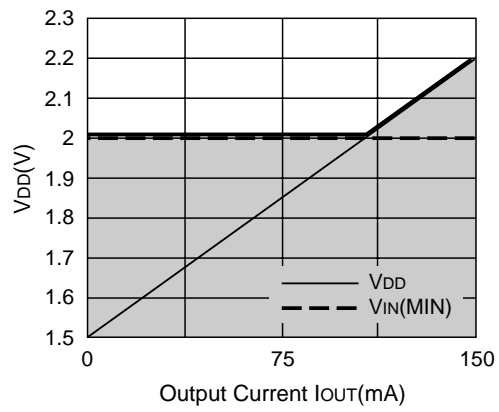

ESR vs. Output Current

When using these ICs, consider the following points:

The relations between I_{OUT} (Output Current) and ESR of an output capacitor are shown below.

The conditions when the white noise level is under $40\mu\text{V}$ (Avg.) are marked as the hatched area in the graph.

Measurement conditions

Frequency Band : 10Hz to 2MHz (BW=30Hz)

Temperature : 25°C

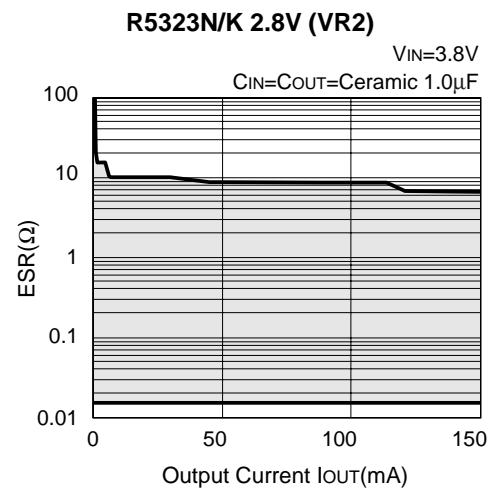
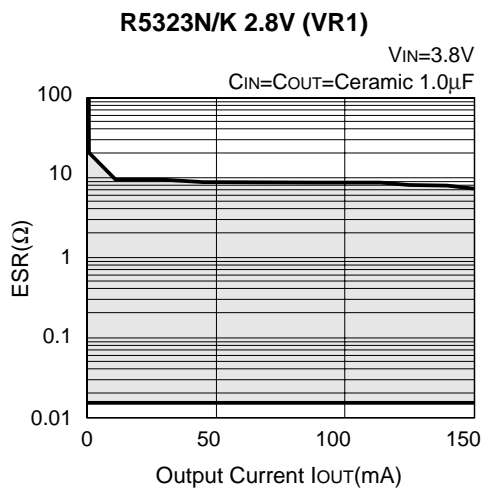
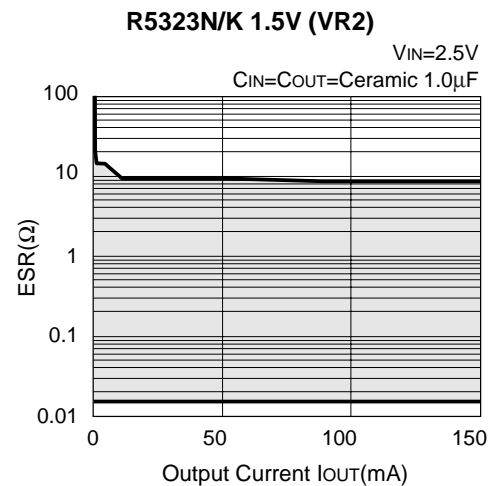
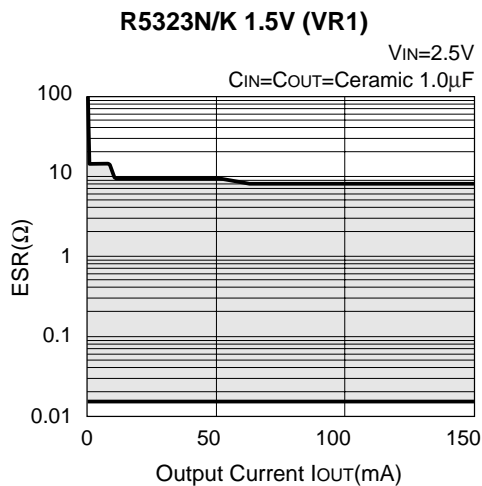

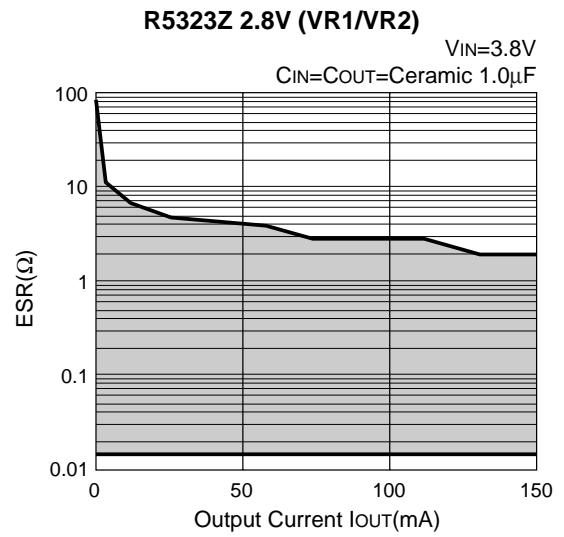
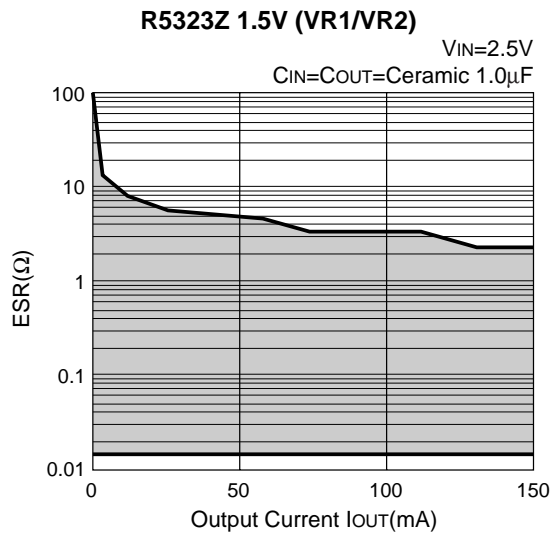

POWER DISSIPATION (SOT-23-6)

This specification is at mounted on board. Power Dissipation (P_D) depends on conditions of mounting on board. This specification is based on the measurement at the condition below:

Measurement Conditions

	Standard Land Pattern
Environment	Mounting on Board (Wind velocity=0m/s)
Board Material	Glass cloth epoxy plactic (Double sided)
Board Dimensions	40mm × 40mm × 1.6mm
Copper Ratio	Top side : Approx. 50% , Back side : Approx. 50%
Through-hole	φ0.5mm × 44pcs

Measurement Result

($T_{opt}=25^{\circ}C, T_{jmax}=125^{\circ}C$)

	Standard Land Pattern	Free Air
Power Dissipation	420mW	250mW
Thermal Resistance	$\theta_{ja}=(125-25^{\circ}C)/0.42W=263^{\circ}C/W$	400 $^{\circ}C/W$

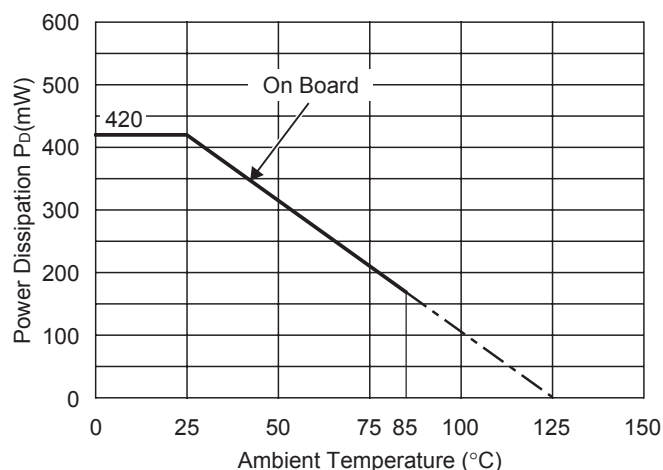

Power Dissipation

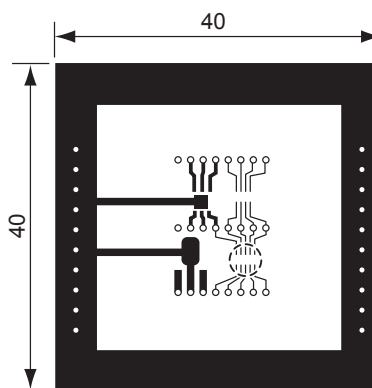

Measurement Board Pattern

○ IC Mount Area Unit : mm

RECOMMENDED LAND PATTERN

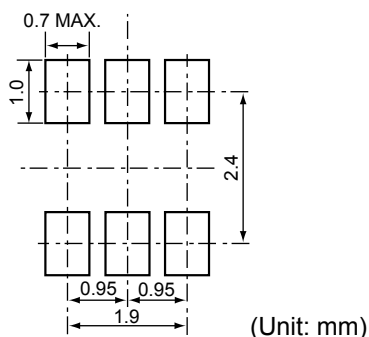

(Unit: mm)

POWER DISSIPATION (DFN(PLP)1820-6)

This specification is at mounted on board. Power Dissipation (P_D) depends on conditions of mounting on board. This specification is based on the measurement at the condition below:

Measurement Conditions

	Standard Land Pattern
Environment	Mounting on Board (Wind velocity=0m/s)
Board Material	Glass cloth epoxy plastic (Double sided)
Board Dimensions	40mm × 40mm × 1.6mm
Copper Ratio	Top side : Approx. 50% , Back side : Approx. 50%
Through-hole	φ0.54mm × 30pcs

Measurement Result ($T_{opt}=25^{\circ}C, T_{jmax}=125^{\circ}C$)

	Standard Land Pattern
Power Dissipation	880mW
Thermal Resistance	$\theta_{ja}=(125-25^{\circ}C)/0.88W=114^{\circ}C/W$

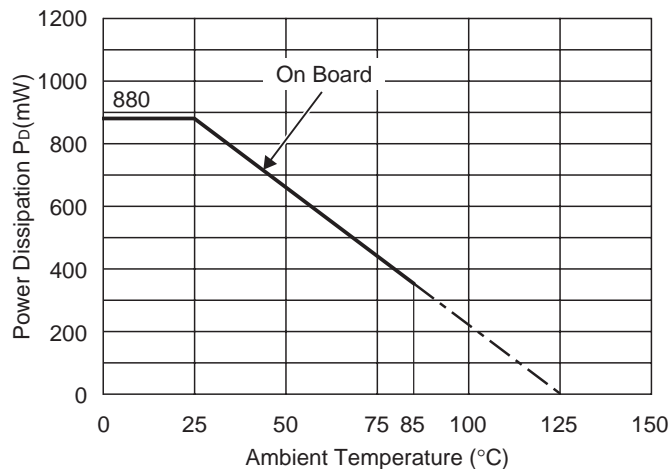

Power Dissipation

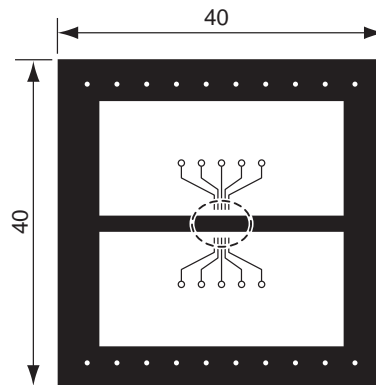

Measurement Board Pattern

○ IC Mount Area Unit : mm

RECOMMENDED LAND PATTERN

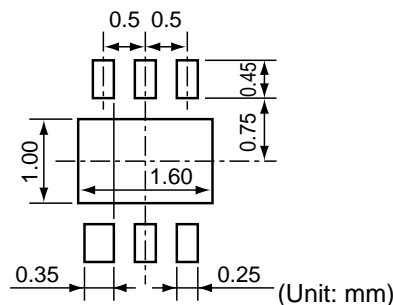

(Unit: mm)

• WLCSP-6-P1

Unit: mm

PACKAGE DIMENSIONS

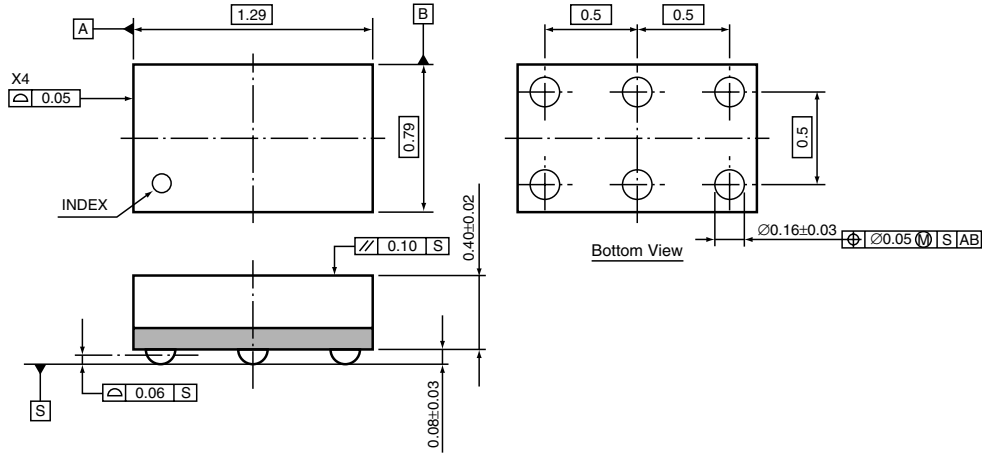

TAPING SPECIFICATION

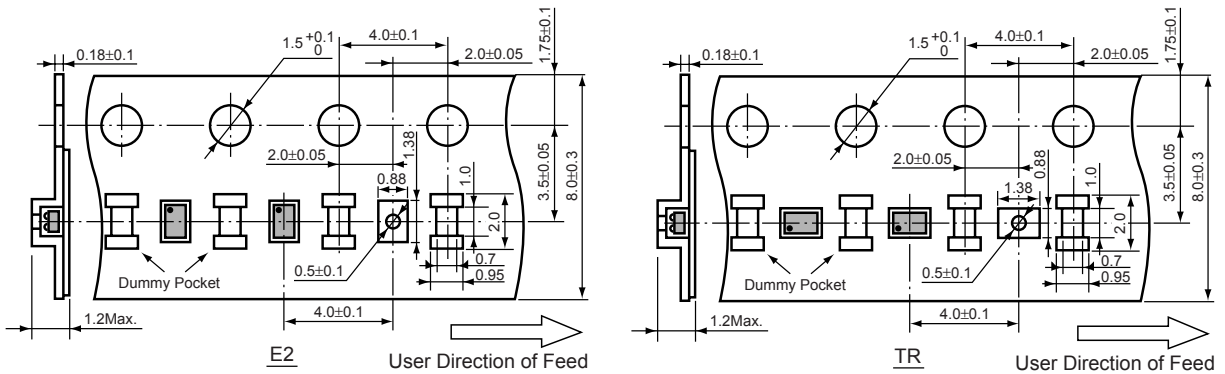

The TAPING SPECIFICATION becomes one kind in each product.
Please refer to SELECTION GUIDE for details.

TAPING REEL DIMENSIONS REUSE REEL (EIAJ-RRM-08Bc)

(1reel=5000pcs : E2 Type)

(1reel=3000pcs : TR Type)

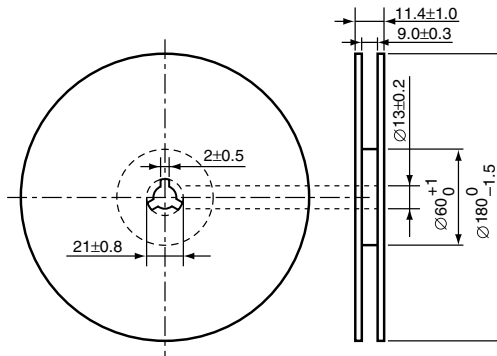

POWER DISSIPATION (WLCSP-6-P1)

This specification is at mounted on board. Power Dissipation (P_D) depends on conditions of mounting on board. This specification is based on the measurement at the condition below:

Measurement Conditions

	Standard Land Pattern
Environment	Mounting on Board (Wind velocity=0m/s)
Board Material	Glass cloth epoxy plactic (Double sided)
Board Dimensions	40mm × 40mm × 1.6mm
Copper Ratio	Top side : Approx. 50% , Back side : Approx. 50%
Through-hole	-

Measurement Result

($T_{opt}=25^{\circ}C, T_{jmax}=125^{\circ}C$)

	Standard Land Pattern
Power Dissipation	633mW
Thermal Resistance	$\theta_{ja}=(125-25^{\circ}C)/0.633W=158^{\circ}C/W$

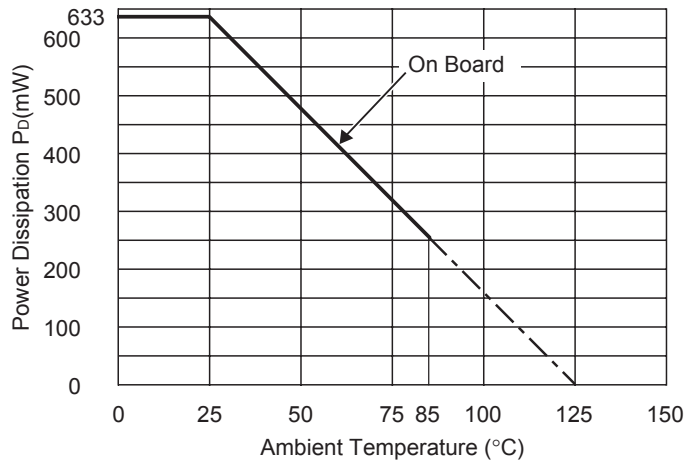

Power Dissipation

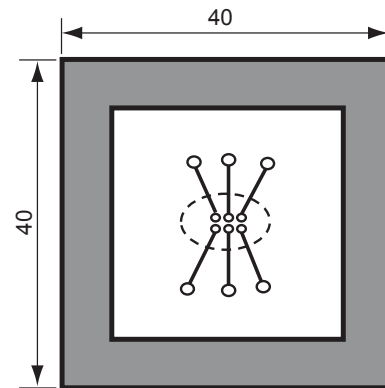

Measurement Board Pattern

○ IC Mount Area (Unit : mm)

RECOMMENDED LAND PATTERN (WLCSP)

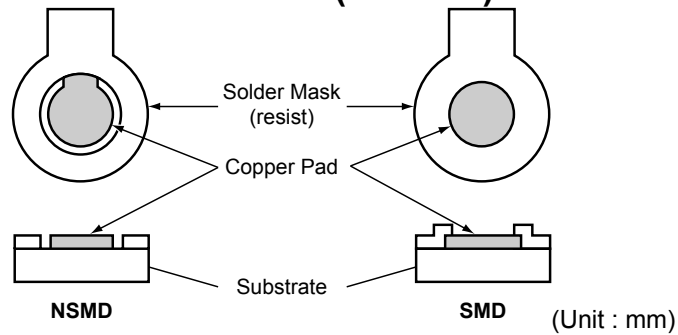

NSMD and SMD Pad Definition

Pad definition	Copper Pad	Solder Mask Opening
NSMD (Non-Solder Mask defined)	0.20mm	Min. 0.30mm
SMD (Solder Mask defined)	Min. 0.30mm	0.20mm

- * Pad layout and size can be modified by customers material, equipment, method.
- * Please adjust pad layout according to your conditions.
- * Recommended Stencil Aperture Size....ø0.3mm
- * Since lead free WL-CSP components are not compatible with the tin/lead solder process, you shall not mount lead free WL-CSP components using the tin/lead solder paste.

R5323N SERIES MARK SPECIFICATION

● SOT-23-6 (SC-74)

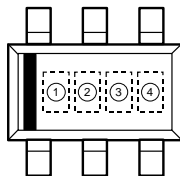

①, ② : Product Code (refer to Part Number vs. Product Code)

③, ④ : Lot Number

● Part Number vs. Product Code

Part Number	Product Code		Set V _{OUT}	
	①	②	VR1	VR2
R5323N001B	N	0	2.8V	2.8V
R5323N002B	N	1	2.9V	2.9V
R5323N003B	N	2	3.0V	3.0V
R5323N004B	N	3	1.8V	1.8V
R5323N005B	N	4	2.7V	2.7V
R5323N006B	N	5	2.5V	2.5V
R5323N007B	N	6	1.5V	1.5V
R5323N008B	N	7	2.8V	4.0V
R5323N009B	N	8	2.5V	2.7V
R5323N010B	N	B	2.6V	2.6V
R5323N011B	U	6	3.3V	3.0V
R5323N012B	N	W	3.3V	2.5V
R5323N013B	N	T	1.8V	3.3V
R5323N014B	N	D	2.8V	2.9V
R5323N015B	N	E	1.5V	3.3V
R5323N016B	N	F	1.5V	2.8V
R5323N017B	N	G	1.5V	2.5V
R5323N018B	N	H	3.2V	3.0V
R5323N019B	N	K	2.8V	3.0V
R5323N020B	N	M	1.5V	2.9V
R5323N021B	N	N	2.9V	1.8V
R5323N022B	N	P	2.8V	1.8V
R5323N023B	N	R	2.8V	3.3V
R5323N024B	U	D	3.0V	3.1V
R5323N025B	U	E	2.9V	3.0V
R5323N026B	N	X	3.3V	1.9V
R5323N027B	N	U	1.8V	2.5V
R5323N028B	U	F	3.1V	3.1V
R5323N029B	N	V	2.85V	2.85V

Part Number	Product Code		Set V _{OUT}	
	①	②	VR1	VR2
R5323N030B	N	Z	2.7V	3.0V
R5323N031B	U	0	1.9V	2.8V
R5323N032B	U	1	2.5V	2.8V
R5323N033B	U	2	2.4V	3.0V
R5323N034B	U	3	2.5V	2.9V
R5323N035B	U	4	1.5V	2.7V
R5323N036B	U	5	2.6V	2.9V
R5323N037B	U	7	1.8V	2.6V
R5323N038B	U	8	1.7V	2.8V
R5323N039B	U	9	1.8V	3.1V
R5323N040B	U	A	1.8V	3.0V
R5323N041B	U	B	2.7V	1.8V
R5323N042B	U	C	3.3V	3.3V
R5323N043B	U	H	2.7V	2.85V
R5323N044B	U	J	2.6V	3.3V
R5323N045B	U	K	1.5V	2.85V
R5323N046B	U	L	1.5V	3.0V
R5323N047B	U	M	2.6V	2.8V

Part Number	Product Code		Set V _{OUT}	
	①	②	VR1	VR2
R5323N001A	U	G	2.8V	2.8V
R5323N002A	N	9	2.9V	2.9V
R5323N003A	N	A	3.0V	3.0V
R5323N013A	N	C	1.8V	3.3V
R5323N019A	N	J	2.8V	3.0V
R5323N020A	N	L	1.5V	2.9V
R5323N023A	N	Q	2.8V	3.3V
R5323N024A	N	S	3.0V	3.1V
R5323N030A	N	Y	2.7V	3.0V

R5323K SERIES MARK SPECIFICATION

• DFN(PLP)1820-6

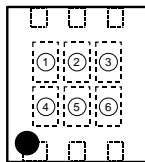

① to ④ : Product Code (refer to Part Number vs. Product Code)

⑤, ⑥ : Lot Number

• Part Number vs. Product Code

Part Number	Product Code				Set V _{OUT}	
	①	②	③	④	VR1	VR2
R5323K001B	C	0	0	1	2.8V	2.8V
R5323K002B	C	0	0	2	2.9V	2.9V
R5323K003B	C	0	0	3	3.0V	3.0V
R5323K004B	C	0	0	4	1.8V	1.8V
R5323K005B	C	0	0	5	2.7V	2.7V
R5323K006B	C	0	0	6	2.5V	2.5V
R5323K007B	C	0	0	7	1.5V	1.5V
R5323K008B	C	0	0	8	2.8V	4.0V
R5323K009B	C	0	0	9	2.5V	2.7V
R5323K010B	C	0	1	2	2.6V	2.6V
R5323K011B	C	0	4	1	3.3V	3.0V
R5323K012B	C	0	3	1	3.3V	2.5V
R5323K013B	C	0	2	8	1.8V	3.3V
R5323K014B	C	0	1	4	2.8V	2.9V
R5323K015B	C	0	1	5	1.5V	3.3V
R5323K016B	C	0	1	6	1.5V	2.8V
R5323K017B	C	0	1	7	1.5V	2.5V
R5323K018B	C	0	1	8	3.2V	3.0V
R5323K019B	C	0	2	0	2.8V	3.0V
R5323K020B	C	0	2	2	1.5V	2.9V
R5323K021B	C	0	2	3	2.9V	1.8V
R5323K022B	C	0	2	4	2.8V	1.8V
R5323K023B	C	0	2	6	2.8V	3.3V
R5323K024B	C	0	4	8	3.0V	3.1V
R5323K025B	C	0	4	9	2.9V	3.0V
R5323K026B	C	0	3	2	3.3V	1.9V
R5323K027B	C	0	2	9	1.8V	2.5V
R5323K028B	C	0	5	0	3.1V	3.1V
R5323K029B	C	0	3	0	2.85V	2.85V

Part Number	Product Code				Set V _{OUT}	
	①	②	③	④	VR1	VR2
R5323K030B	C	0	3	4	2.7V	3.0V
R5323K031B	C	0	3	5	1.9V	2.8V
R5323K032B	C	0	3	6	2.5V	2.8V
R5323K033B	C	0	3	7	2.4V	3.0V
R5323K034B	C	0	3	8	2.5V	2.9V
R5323K035B	C	0	3	9	1.5V	2.7V
R5323K036B	C	0	4	0	2.6V	2.9V
R5323K037B	C	0	4	2	1.8V	2.6V
R5323K038B	C	0	4	3	1.7V	2.8V
R5323K039B	C	0	4	4	1.8V	3.1V
R5323K040B	C	0	4	5	1.8V	3.0V
R5323K041B	C	0	4	6	2.7V	1.8V
R5323K042B	C	0	4	7	3.3V	3.3V
R5323K043B	C	0	5	2	2.7V	2.85V
R5323K044B	C	0	5	3	2.6V	3.3V
R5323K045B	C	0	5	4	1.5V	2.85V
R5323K046B	C	0	5	5	1.5V	3.0V
R5323K047B	C	0	5	6	2.6V	2.8V

Part Number	Product Code				Set V _{OUT}	
	①	②	③	④	VR1	VR2
R5323K001A	C	0	5	1	2.8V	2.8V
R5323K002A	C	0	1	0	2.9V	2.9V
R5323K003A	C	0	1	1	3.0V	3.0V
R5323K013A	C	0	1	3	1.8V	3.3V
R5323K019A	C	0	1	9	2.8V	3.0V
R5323K020A	C	0	2	1	1.5V	2.9V
R5323K023A	C	0	2	5	2.8V	3.3V
R5323K024A	C	0	2	7	3.0V	3.1V
R5323K030A	C	0	3	3	2.7V	3.0V

R5323Z SERIES MARK SPECIFICATION

• WLCSP-6-P1

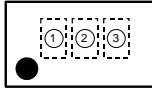

① : G (Fixed)

②, ③ : Lot Number

• Product Code vs. Marking

Part Number	Product Code	Set V _{OUT}	
	①	VR1	VR2
R5323Z001A	G	2.8V	2.8V
R5323Z002A	G	2.9V	2.9V
R5323Z003A	G	3.0V	3.0V
R5323Z004A	G	1.8V	1.8V
R5323Z005A	G	2.7V	2.7V
R5323Z006A	G	2.5V	2.5V
R5323Z007A	G	1.5V	1.5V
R5323Z008A	G	2.8V	4.0V
R5323Z009A	G	2.5V	2.7V
R5323Z010A	G	2.6V	2.6V
R5323Z011A	G	3.3V	3.0V
R5323Z012A	G	3.3V	2.5V
R5323Z013A	G	1.8V	3.3V
R5323Z014A	G	2.8V	2.9V
R5323Z015A	G	1.5V	3.3V
R5323Z016A	G	1.5V	2.8V
R5323Z017A	G	1.5V	2.5V
R5323Z018A	G	3.2V	3.0V
R5323Z019A	G	2.8V	3.0V
R5323Z020A	G	1.5V	2.9V
R5323Z021A	G	2.9V	1.8V
R5323Z022A	G	2.8V	1.8V
R5323Z023A	G	2.8V	3.3V
R5323Z024A	G	3.0V	3.1V
R5323Z025A	G	2.9V	3.0V
R5323Z026A	G	3.3V	1.9V
R5323Z027A	G	1.8V	2.5V
R5323Z028A	G	3.1V	3.1V
R5323Z029A	G	2.85V	2.85V
R5323Z030A	G	2.7V	3.0V
R5323Z031A	G	1.9V	2.8V
R5323Z032A	G	2.5V	2.8V
R5323Z033A	G	2.4V	3.0V
R5323Z034A	G	2.5V	2.9V
R5323Z035A	G	1.5V	2.7V

Part Number	Product Code	Set V _{OUT}	
	①	VR1	VR2
R5323Z036A	G	2.6V	2.9V
R5323Z037A	G	1.8V	2.6V
R5323Z038A	G	1.7V	2.8V
R5323Z039A	G	1.8V	3.1V
R5323Z040A	G	1.8V	3.0V
R5323Z041A	G	2.7V	1.8V
R5323Z042A	G	3.3V	3.3V
R5323Z043A	G	2.7V	2.85V
R5323Z044A	G	2.6V	3.3V
R5323Z045A	G	1.5V	2.85V
R5323Z046A	G	1.5V	3.0V
R5323Z047A	G	2.6V	2.8V

Part Number	Product Code	Set V _{OUT}	
	①	VR1	VR2
R5323Z001B	G	2.8V	2.8V
R5323Z002B	G	2.9V	2.9V
R5323Z003B	G	3.0V	3.0V
R5323Z004B	G	1.8V	1.8V
R5323Z005B	G	2.7V	2.7V
R5323Z006B	G	2.5V	2.5V
R5323Z007B	G	1.5V	1.5V
R5323Z008B	G	2.8V	4.0V
R5323Z009B	G	2.5V	2.7V
R5323Z010B	G	2.6V	2.6V
R5323Z011B	G	3.3V	3.0V
R5323Z012B	G	3.3V	2.5V
R5323Z013B	G	1.8V	3.3V
R5323Z014B	G	2.8V	2.9V
R5323Z015B	G	1.5V	3.3V
R5323Z016B	G	1.5V	2.8V
R5323Z017B	G	1.5V	2.5V
R5323Z018B	G	3.2V	3.0V
R5323Z019B	G	2.8V	3.0V
R5323Z020B	G	1.5V	2.9V
R5323Z021B	G	2.9V	1.8V
R5323Z022B	G	2.8V	1.8V
R5323Z023B	G	2.8V	3.3V
R5323Z024B	G	3.0V	3.1V
R5323Z025B	G	2.9V	3.0V
R5323Z026B	G	3.3V	1.9V
R5323Z027B	G	1.8V	2.5V
R5323Z028B	G	3.1V	3.1V
R5323Z029B	G	2.85V	2.85V
R5323Z030B	G	2.7V	3.0V
R5323Z031B	G	1.9V	2.8V
R5323Z032B	G	2.5V	2.8V
R5323Z033B	G	2.4V	3.0V
R5323Z034B	G	2.5V	2.9V
R5323Z035B	G	1.5V	2.7V

Part Number	Product Code	Set V _{OUT}	
	①	VR1	VR2
R5323Z036B	G	2.6V	2.9V
R5323Z037B	G	1.8V	2.6V
R5323Z038B	G	1.7V	2.8V
R5323Z039B	G	1.8V	3.1V
R5323Z040B	G	1.8V	3.0V
R5323Z041B	G	2.7V	1.8V
R5323Z042B	G	3.3V	3.3V
R5323Z043B	G	2.7V	2.85V
R5323Z044B	G	2.6V	3.3V
R5323Z045B	G	1.5V	2.85V
R5323Z046B	G	1.5V	3.0V
R5323Z047B	G	2.6V	2.8V