

MM54C941/MM74C941 Octal Buffers/Line Receivers/ Line Drivers with TRI-STATE® Outputs

General Description

These octal buffers and line drivers are monolithic complementary MOS (CMOS) integrated circuits with TRI-STATE outputs. These outputs have been specially designed to drive highly capacitive loads such as bus-oriented systems. These devices have a fan-out of 6 low power Schottky loads. When $V_{CC} = 5V$, inputs can accept true TTL high and low logic levels.

Features

- Wide supply voltage range (3V to 15V)
- Low power consumption
- TTL compatibility (Improved on the inputs)
- High capacitive load
- TRI-STATE outputs
- Input protection
- 20-pin dual-in-line package
- High output drive

Connection and Logic Diagrams

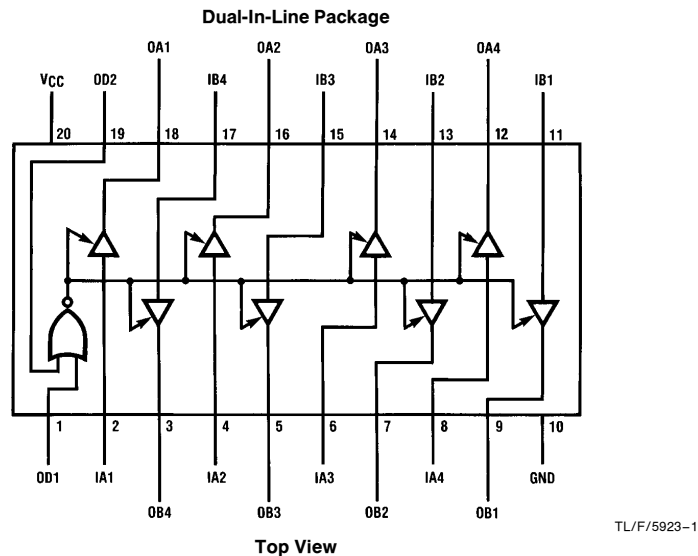

Order Number MM54C941 or MM74C941

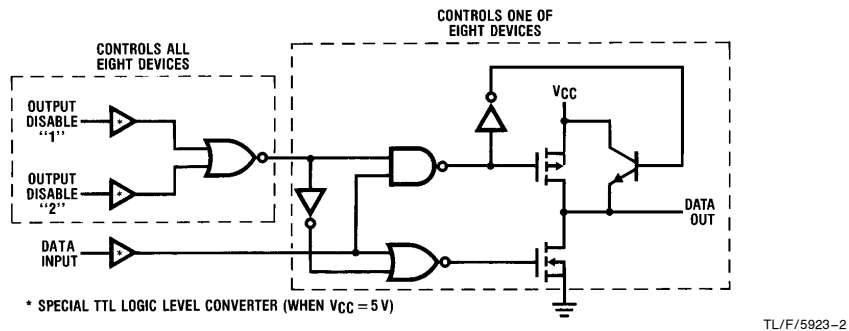

TRI-STATE® is a registered trademark of National Semiconductor Corporation.

Absolute Maximum Ratings (Note 1)

If Military/Aerospace specified devices are required, please contact the National Semiconductor Sales Office/Distributors for availability and specifications.

Voltage at Any Pin	0.3V to $V_{CC} + 0.3V$
Operating Temperature Range (T_A)	
MM54C941	-55°C to +125°C
MM74C941	-40°C to +85°C

Storage Temperature Range (T_S)	-65°C to +150°C
Power Dissipation (P_D)	
Dual-In-Line	700 mW
Small Outline	500 mW
Operating V_{CC} Range	3V to 15V
V_{CC}	18V
Lead Temperature (T_L)	
(Soldering, 10 seconds)	260°C

DC Electrical Characteristics Min/Max limits apply across temperature range, unless otherwise noted

Symbol	Parameter	Conditions	Min	Typ	Max	Units
CMOS TO CMOS						
$V_{IN(1)}$	Logical "1" Input Voltage	$V_{CC} = 5.0V$ $V_{CC} = 10V$	2.5 8.0			V V
$V_{IN(0)}$	Logical "0" Input Voltage	$V_{CC} = 5.0V$ $V_{CC} = 10V$			0.8 2.0	V V
$V_{OUT(1)}$	Logical "1" Output Voltage	$V_{CC} = 5.0V, I_O = -10\mu A$ $V_{CC} = 10V, I_O = -10\mu A$	4.5 9.0			V V
$V_{OUT(0)}$	Logical "0" Output Voltage	$V_{CC} = 5.0V, I_O = 10\mu A$ $V_{CC} = 10V, I_O = 10\mu A$			0.5 1.0	V V
$I_{IN(1)}$	Logical "1" Input Current	$V_{CC} = 15V, V_{IN} = 15V$		0.005	1.0	μA
$I_{IN(0)}$	Logical "0" Input Current	$V_{CC} = 15V, V_{IN} = 0V$	-1.0	-0.005		μA
I_{CC}	Supply Current	$V_{CC} = 15V$		0.05	300	μA
I_{OZ}	TRI-STATE Leakage	$V_{CC} = 15V, V_{OUT} = 0V$ or 15V			± 10	μA

CMOS/TTL INTERFACE

$V_{IN(1)}$	Logical "1" Input Voltage	54C, $V_{CC} = 4.5V$ 74C, $V_{CC} = 4.75V$	$V_{CC}-2.5$ $V_{CC}-2.5$			V V
$V_{IN(0)}$	Logical "0" Input Voltage	54C, $V_{CC} = 4.5V$ 74C, $V_{CC} = 4.75V$			0.8 0.8	V V
$V_{OUT(1)}$	Logical "1" Output Voltage	54C, $V_{CC} = 4.5V, I_O = -450\mu A$ 74C, $V_{CC} = 4.75V, I_O = -450\mu A$ 54C, $V_{CC} = 4.5V, I_O = -2.2mA$ 74C, $V_{CC} = 4.75V, I_O = -2.2mA$	$V_{CC}-0.4$ $V_{CC}-0.4$ 2.4 2.4			V V V V
$V_{OUT(0)}$	Logical "0" Output Voltage	54C, $V_{CC} = 4.5V, I_O = 2.2mA$ 74C, $V_{CC} = 4.75V, I_O = 2.2mA$			0.4 0.4	V V

OUTPUT DRIVE (See 54C/74C Family Characteristics Data Sheet)

I_{SOURCE}	Output Source Current (P-Channel)	$V_{CC} = 5.0V, V_{OUT} = 0V$ $T_A = 25^\circ C$	-14.0	-30.0		mA
I_{SOURCE}	Output Source Current (P-Channel)	$V_{CC} = 10V, V_{OUT} = 0V$ $T_A = 25^\circ C$	-36.0	-70.0		mA
I_{SINK}	Output Sink Current (N-Channel)	$V_{CC} = 5.0V, V_{OUT} = V_{CC}$ $T_A = 25^\circ C$	12.0	20.0		mA
I_{SINK}	Output Sink Current (N-Channel)	$V_{CC} = 10V, V_{OUT} = V_{CC}$ $T_A = 25^\circ C$	48.0	70		mA

Note 1: "Absolute Maximum Ratings" are those values beyond which the safety of the device cannot be guaranteed. Except for "Operating Temperature Range" they are not meant to imply that the devices should be operated at these limits. The table of "Electrical Characteristics" provides conditions for actual device operation.

AC Electrical Characteristics* $T_A = 25^\circ\text{C}$, $C_L = 50\text{ pF}$, unless otherwise specified

Symbol	Parameter	Conditions	Min	Typ	Max	Units
t_{pd1} , t_{pd0}	Propagation Delay (Data IN to OUT)	$V_{CC} = 5.0\text{V}$, $C_L = 50\text{ pF}$		70	140	ns
		$V_{CC} = 10\text{V}$, $C_L = 50\text{ pF}$		35	70	ns
		$V_{CC} = 5.0\text{V}$, $C_L = 150\text{ pF}$		90	160	ns
		$V_{CC} = 10\text{V}$, $C_L = 150\text{ pF}$		45	90	ns
t_{IH} , t_{OH}	Propagation Delay Output Disable to Logic Level (from High Impedance State) (from a Logic Level)	$R_L = 1\text{ k}\Omega$, $C_L = 50\text{ pF}$		100	200	ns
		$V_{CC} = 5.0\text{V}$ $V_{CC} = 210\text{V}$		55	110	ns
t_{H1} , t_{H0}	Propagation Delay Output Disable to Logic Level (from High Impedance State)	$R_L = 1\text{ k}\Omega$, $C_L = 50\text{ pF}$		100	200	ns
		$V_{CC} = 5.0\text{V}$ $V_{CC} = 10\text{V}$		55	110	ns
t_{THL} , t_{TLH}	Transition Time	$V_{CC} = 5.0\text{V}$, $C_L = 50\text{ pF}$		50	100	ns
		$V_{CC} = 10\text{V}$, $C_L = 50\text{ pF}$		30	60	ns
		$V_{CC} = 5.0\text{V}$, $C_L = 150\text{ pF}$		80	160	ns
		$V_{CC} = 10\text{V}$, $C_L = 150\text{ pF}$		50	100	ns
C_{PD}	Power Dissipation Capacitance (Output Enabled per Buffer) (Output Disabled per Buffer)	(Note 3)		100		pF
				10		pF
C_{IN}	Input Capacitance (Any Input)	(Note 2) $V_{IN} = 0\text{V}$, $f = 1\text{ MHz}$, $T_A = 25^\circ\text{C}$		10		pF
C_O	(Output Capacitance) (Output Disabled)	$V_{IN} = 0\text{V}$, $f = 1\text{ MHz}$, $T_A = 25^\circ\text{C}$		10		pF

*AC Parameters are guaranteed by DC correlated testing.

Note 1: "Absolute Maximum Ratings" are those values beyond which the safety of the device cannot be guaranteed. Except for "Operating Temperature Range" they are not meant to imply that the devices should be operated at these limits. The table of "Electrical Characteristics" provides conditions for actual device operation.

Note 2: Capacitance is guaranteed by periodic testing.

Note 3: C_{PD} determines the no load AC power consumption of any CMOS device. For complete explanation see 54C/74C Family Characteristics Application Note, AN-90.

Truth Table

OD1	OD2	Input	Output
0	0	0	0
0	0	1	1
0	1	X	Z
1	0	X	Z
1	1	X	Z

1 = High

0 = Low

X = Don't Care

Z = TRI-STATE

Typical Performance Characteristics

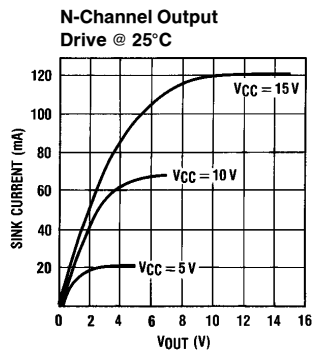

TL/F/5923-3

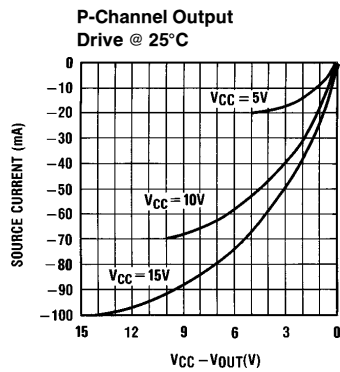

TL/F/5923-4

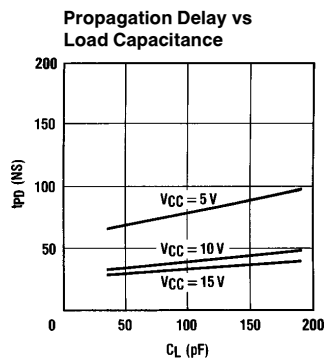

TL/F/5923-5

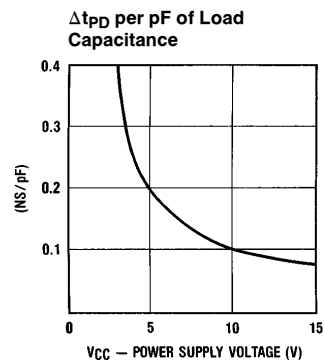

TL/F/5923-6

Typical Application

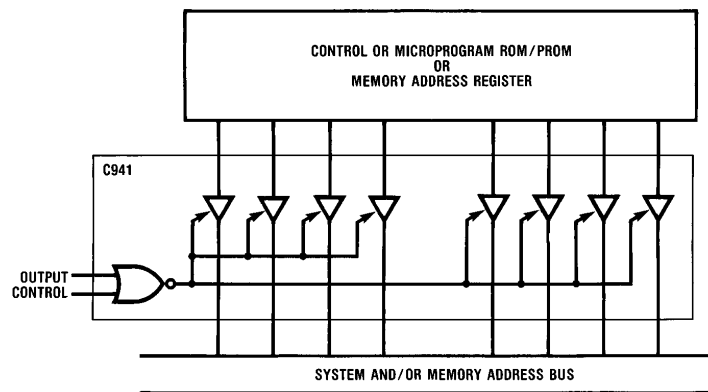

TL/F/5923-7

AC Test Circuits and Switching Time Waveforms

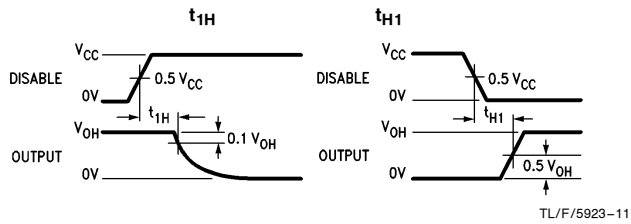
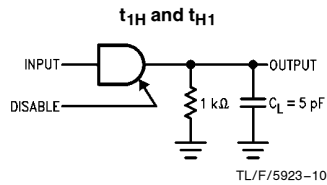
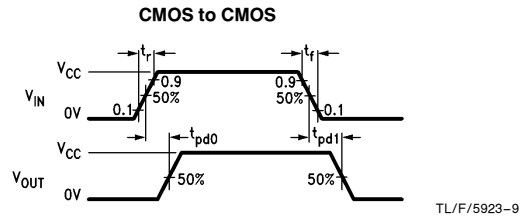
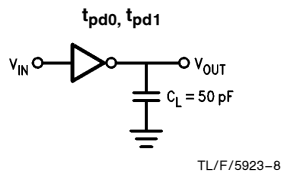

Note: V_{OH} is defined as the DC output high voltage when the device is loaded with a 1 k Ω resistor to ground.

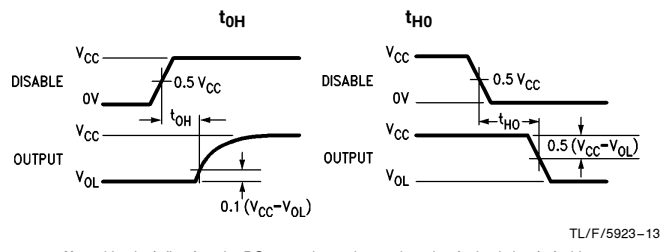
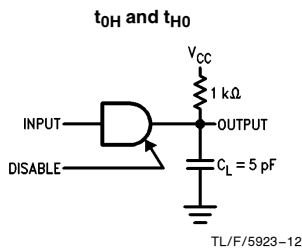

Note: Delays measured with input t_r , $t_f \leq 20$ ns.

Note: V_{OL} is defined as the DC output low voltage when the device is loaded with a 1 k Ω resistor to V_{CC} .

Physical Dimensions inches (millimeters)

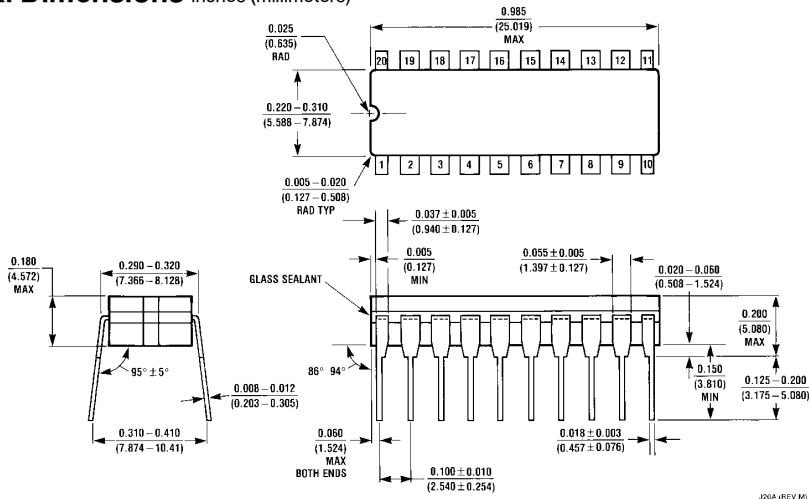

Ceramic Dual-In-Line Package (J)
Order Number MM54C941J or MM74C941J
NS Package Number J20A

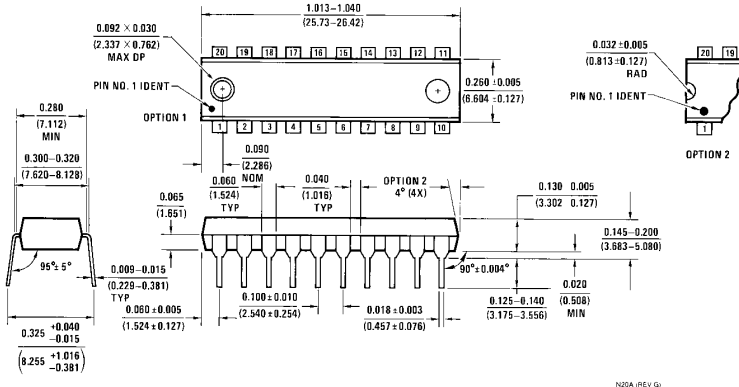

Molded Dual-In-Line Package (N)
Order Number MM54C941N or MM74C941N
NS Package Number N20A

LIFE SUPPORT POLICY

NATIONAL'S PRODUCTS ARE NOT AUTHORIZED FOR USE AS CRITICAL COMPONENTS IN LIFE SUPPORT DEVICES OR SYSTEMS WITHOUT THE EXPRESS WRITTEN APPROVAL OF THE PRESIDENT OF NATIONAL SEMICONDUCTOR CORPORATION. As used herein:

1. Life support devices or systems are devices or systems which, (a) are intended for surgical implant into the body, or (b) support or sustain life, and whose failure to perform, when properly used in accordance with instructions for use provided in the labeling, can be reasonably expected to result in a significant injury to the user.
2. A critical component is any component of a life support device or system whose failure to perform can be reasonably expected to cause the failure of the life support device or system, or to affect its safety or effectiveness.

 <p>National Semiconductor Corporation 1111 West Bardin Road Arlington, TX 76017 Tel: (800) 272-9959 Fax: (800) 737-7018</p>	<p>National Semiconductor Europe</p> <p>Fax: (+49) 0-180-530 85 86 Email: cnjwge@tevm2.nsc.com Deutsch Tel: (+49) 0-180-530 85 85 English Tel: (+49) 0-180-532 78 32 Français Tel: (+49) 0-180-532 93 58 Italiano Tel: (+49) 0-180-534 16 80</p>	<p>National Semiconductor Hong Kong Ltd. 19th Floor, Straight Block, Ocean Centre, 5 Canton Rd. Tsimshatsui, Kowloon Hong Kong Tel: (852) 2737-1600 Fax: (852) 2736-9960</p>	<p>National Semiconductor Japan Ltd. Tel: 81-043-299-2309 Fax: 81-043-299-2408</p>
--	--	---	---

National does not assume any responsibility for use of any circuitry described, no circuit patent licenses are implied and National reserves the right at any time without notice to change said circuitry and specifications.