

RF Power Field Effect Transistors

N-Channel Enhancement-Mode Lateral MOSFETs

Designed for broadband commercial and industrial applications with frequencies to 1000 MHz. The high gain and broadband performance of these devices make them ideal for large-signal, common-source amplifier applications in 26 volt base station equipment.

- Typical Single-Carrier N-CDMA Performance @ 880 MHz: $V_{DD} = 26$ Volts, $I_{DQ} = 2400$ mA, $P_{out} = 40$ Watts Avg., IS-95 CDMA (Pilot, Sync, Paging, Traffic Codes 8 Through 13). Channel Bandwidth = 1.2288 MHz. Peak/Avg. = 9.8 dB @ 0.01% Probability on CCDF.
Power Gain — 17.5 dB
Drain Efficiency — 25%
ACPR @ 750 kHz Offset — -46.5 dBc in 30 kHz Bandwidth
- Capable of Handling 10:1 VSWR, @ 26 Vdc, 880 MHz, 40 Watts CW Output Power

Features

- Characterized with Series Equivalent Large-Signal Impedance Parameters
- Internally Matched for Ease of Use
- Integrated ESD Protection
- Low Gold Plating Thickness on Leads, 40 μ " Nominal.
- RoHS Compliant
- In Tape and Reel. R3 Suffix = 250 Units per 56 mm, 13 inch Reel.

MRF9200LR3
MRF9200LSR3

880 MHz, 40 W AVG., 26 V
SINGLE N-CDMA
LATERAL N-CHANNEL
RF POWER MOSFETS

CASE 465B-03, STYLE 1
NI-880
MRF9200LR3

CASE 465C-02, STYLE 1
NI-880S
MRF9200LSR3

Table 1. Maximum Ratings

Rating	Symbol	Value	Unit
Drain-Source Voltage	V_{DSS}	-0.5, +65	Vdc
Gate-Source Voltage	V_{GS}	-0.5, +15	Vdc
Total Device Dissipation @ $T_C = 25^\circ\text{C}$ Derate above 25 $^\circ\text{C}$	P_D	625 3.6	W W/ $^\circ\text{C}$
Storage Temperature Range	T_{stg}	- 65 to +150	$^\circ\text{C}$
Case Operating Temperature	T_C	150	$^\circ\text{C}$
Operating Junction Temperature	T_J	200	$^\circ\text{C}$

Table 2. Thermal Characteristics

Characteristic	Symbol	Value (1,2)	Unit
Thermal Resistance, Junction to Case Case Temperature 60 $^\circ\text{C}$, 200 W CW Case Temperature 80 $^\circ\text{C}$, 40 W CW	$R_{\theta JC}$	0.28 0.34	$^\circ\text{C}/\text{W}$

1. MTTF calculator available at <http://www.freescale.com/rf>. Select Tools/Software/Application Software/Calculators to access the MTTF calculators by product.
2. Refer to AN1955, *Thermal Measurement Methodology of RF Power Amplifiers*. Go to <http://www.freescale.com/rf>. Select Documentation/Application Notes - AN1955.

Table 3. ESD Protection Characteristics

Test Conditions	Class
Human Body Model (per JESD22-A114)	1C (Minimum)
Machine Model (per EIA/JESD22-A115)	B (Minimum)
Charge Device Model (per JESD22-C101)	IV (Minimum)

Table 4. Electrical Characteristics ($T_C = 25^\circ\text{C}$ unless otherwise noted)

Characteristic	Symbol	Min	Typ	Max	Unit
Off Characteristics					
Zero Gate Voltage Drain Leakage Current ($V_{DS} = 65\text{ Vdc}$, $V_{GS} = 0\text{ Vdc}$)	I_{DSS}	—	—	10	μA
Zero Gate Voltage Drain Leakage Current ($V_{DS} = 26\text{ Vdc}$, $V_{GS} = 0\text{ Vdc}$)	I_{DSS}	—	—	1	μA
Gate-Source Leakage Current ($V_{GS} = 5\text{ Vdc}$, $V_{DS} = 0\text{ Vdc}$)	I_{GSS}	—	—	1	μA
On Characteristics					
Gate Threshold Voltage ($V_{DS} = 10\text{ Vdc}$, $I_D = 100\ \mu\text{A}$)	$V_{GS(th)}$	1.5	2.7	3.5	Vdc
Gate Quiescent Voltage ($V_{DS} = 26\text{ Vdc}$, $I_D = 2400\ \text{mA}$)	$V_{GS(Q)}$	3	3.7	4.5	Vdc
Drain-Source On-Voltage ($V_{GS} = 10\text{ Vdc}$, $I_D = 6.0\ \text{A}$)	$V_{DS(on)}$	—	0.25	0.4	Vdc
Forward Transconductance ($V_{DS} = 10\text{ Vdc}$, $I_D = 6.7\ \text{A}$)	g_{fs}	—	8.8	—	S
Dynamic Characteristics ⁽¹⁾					
Reverse Transfer Capacitance ($V_{DS} = 26\text{ Vdc} \pm 30\ \text{mV(rms)}$ ac @ 1 MHz, $V_{GS} = 0\text{ Vdc}$)	C_{rss}	—	2.5	—	pF

Functional Tests (In Freescale Test Fixture, 50 ohm system) $V_{DD} = 26\text{ Vdc}$, $I_{DQ} = 2400\ \text{mA}$, $P_{out} = 40\ \text{W Avg. N-CDMA}$, $f = 880\ \text{MHz}$, Single-Carrier N-CDMA, 1.2288 MHz Channel Bandwidth Carrier. ACPR measured in 30 kHz Channel Bandwidth @ $\pm 750\ \text{kHz}$ Offset. Peak/Avg. = 9.8 dB @ 0.01% Probability on CCDF.

Power Gain	G_{ps}	16	17.5	—	dB
Drain Efficiency	η_D	22	25	—	%
Adjacent Channel Power Ratio	ACPR	—	-46.5	-45	dBc
Input Return Loss	IRL	—	-13	-9	dB

1. Part internally matched both on input and output.

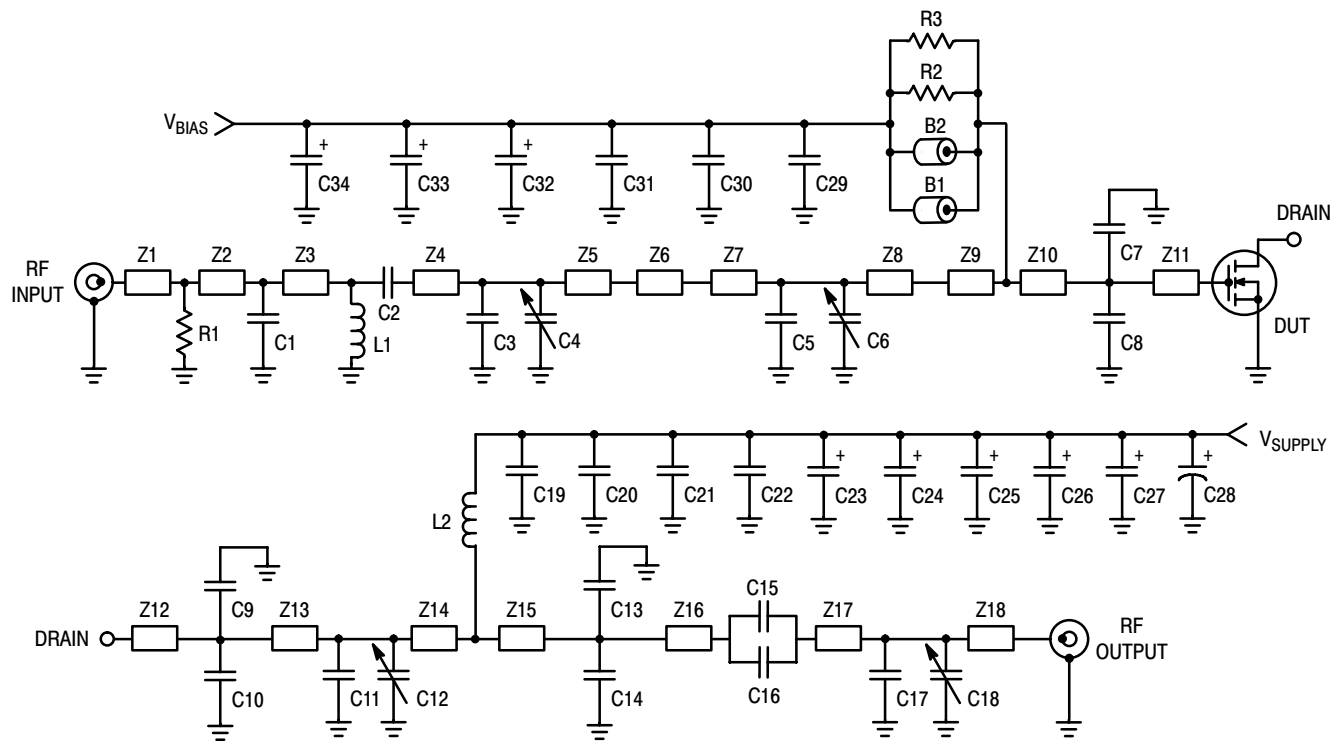

Z1	0.015" x 0.083" Microstrip	Z8	0.335" x 0.397" Microstrip	Z14	0.197" x 0.750" x 0.111" Taper
Z2	0.048" x 0.083" Microstrip	Z9	0.134" x 0.825" x 0.090" Taper	Z15	0.331" x 0.115" Microstrip
Z3	0.352" x 0.083" Microstrip	Z10	0.209" x 0.825" Microstrip	Z16	0.557" x 0.830" Microstrip
Z4	0.086" x 0.050" Microstrip	Z11	0.148" x 0.825" Microstrip	Z17	0.078" x 0.830" Microstrip
Z5	0.367" x 0.050" Microstrip	Z12	0.148" x 0.750" Microstrip	Z18	0.414" x 0.750" Microstrip
Z6	0.417" x 0.115" Microstrip	Z13	0.435" x 0.750" Microstrip	PCB	Arlon, 0.030", $\epsilon_r = 2.56$
Z7	0.068" x 0.397" Microstrip				

Figure 1. MRF9200LR3(SR3) Test Circuit Schematic

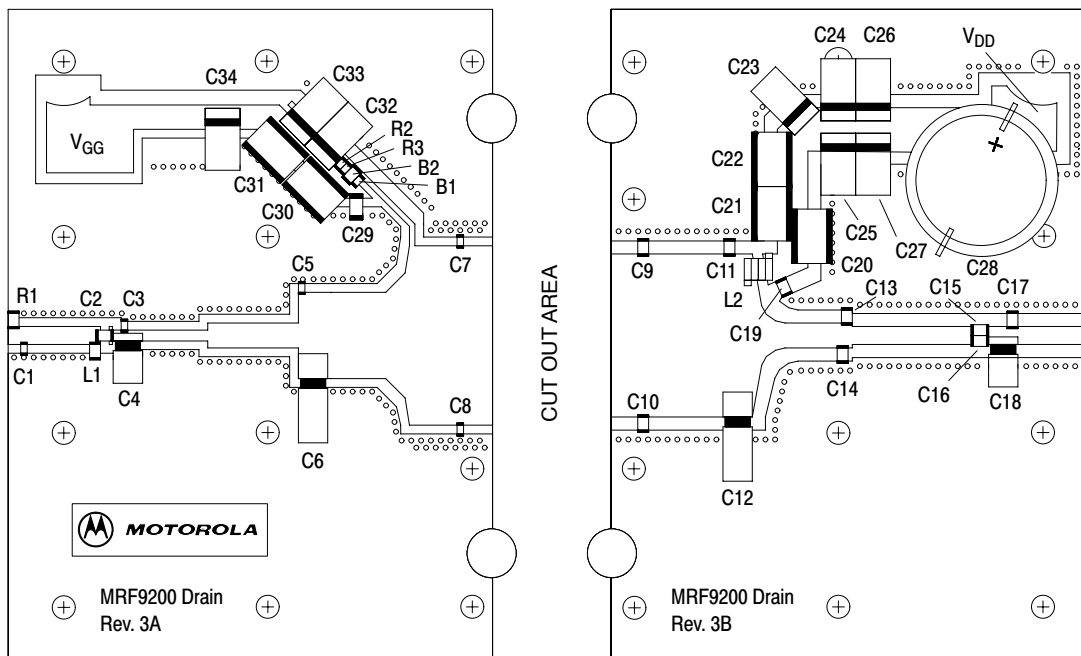

Freescale has begun the transition of marking Printed Circuit Boards (PCBs) with the Freescale Semiconductor signature/logo. PCBs may have either Motorola or Freescale markings during the transition period. These changes will have no impact on form, fit or function of the current product.

Figure 2. MRF9200LR3(SR3) Test Circuit Component Layout

Table 5. MRF9200LR3(SR3) Test Circuit Component Designations and Values

Part	Description	Part Number	Manufacturer
B1	RF Bead, Surface Mount (0603)	2506033007Y0	Fair-Rite
B2	RF Bead, Surface Mount (0805)	2508051107Y0	Fair-Rite
C1	2.2 pF Chip Capacitor (0603)	GQM1885C2A2R2CB01B	Murata
C2, C19	47 pF Chip Capacitors (0805)	GQM2195C1H470JB01B	Murata
C3	2.0 pF Chip Capacitor (0603)	GQM1885C2A2R0BB01B	Murata
C4, C18	0.4 - 2.5 pF Variable Capacitors	27283PC	Gigatronics
C5	8.2 pF Chip Capacitor (0603)	GQM1885C1H8R2DB01B	Murata
C6, C12	0.8 - 8.0 pF Variable Capacitors	27291SL	Gigatronics
C7, C8	12 pF Chip Capacitors (0603)	GQM1885C1H120JB01B	Murata
C9, C10	10 pF Chip Capacitors (0805)	GQM2195C2A100JB01B	Murata
C11	5.1 pF Chip Capacitor (0805)	GQM2195C2A5R1DB01B	Murata
C13	3.3 pF Chip Capacitor (0805)	GQM2195C2A3R3CB01B	Murata
C14, C17	1.5 pF Chip Capacitors (0805)	GQM2195C2A1R5CB01B	Murata
C15, C16	22 pF Chip Capacitors (0805)	GQM2195C1H220JB01B	Murata
C20	0.56 μ F Chip Capacitor (1825)	C1825C564J5RAC	Kemet
C21, C22, C31	2.2 μ F Chip Capacitors (1825)	C1825C225J5RAC	Kemet
C23	10 μ F, 50 V Tantalum Chip Capacitor	522Z-050/100MTRE	Tecate
C24, C25, C26, C27	22 μ F, 35 V Tantalum Chip Capacitors	T491X226K035AS	Kemet
C28	330 μ F, 63 V Electrolytic Capacitor	NACZF331M100V (18X22)	Nippon
C29	10 μ F Chip Capacitor (1206)	GRM31MF51A106ZA01B	Murata
C30	0.01 μ F Chip Capacitor (1825)	C1825C103J1RAC	Kemet
C32, C33	22 μ F, 25 V Tantalum Chip Capacitors	ECS-T1ED226R	Panasonic TE series
C34	47 μ F, 16 V Tantalum Chip Capacitor	T491D476K016AS	Kemet
L1	22 nH Chip Inductor (0805)	L0805220JEW	AVX
L2	8 nH Inductor	A03T-5	CoilCraft
R1	510 Ω , 1/10 W Chip Resistor (0805)		Dale/Vishay
R2, R3	11 Ω , 1/8 W Chip Resistors (1206)		Dale/Vishay

MRF9200LR3 MRF9200LSR3

RF Device Data
Freescale Semiconductor

TYPICAL CHARACTERISTICS

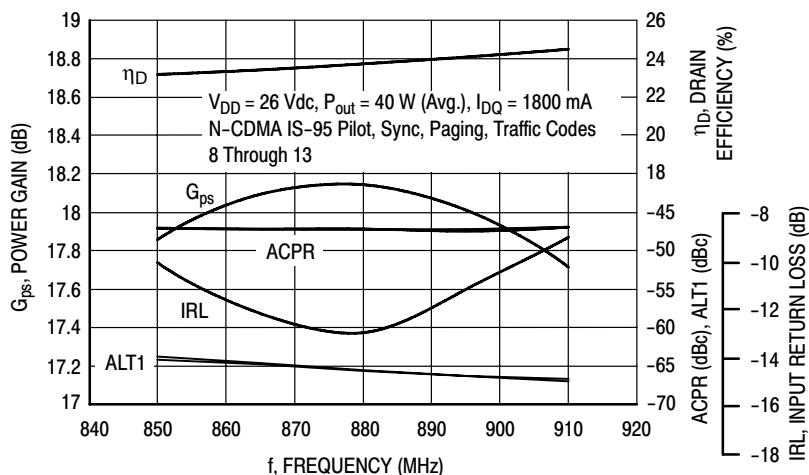

Figure 3. Single-Carrier N-CDMA Broadband Performance @ $P_{out} = 40$ Watts Avg.

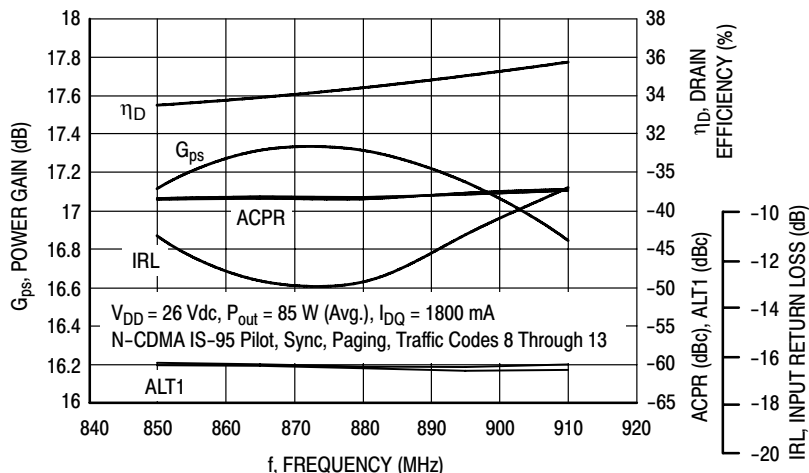

Figure 4. Single-Carrier N-CDMA Broadband Performance @ $P_{out} = 85$ Watts Avg.

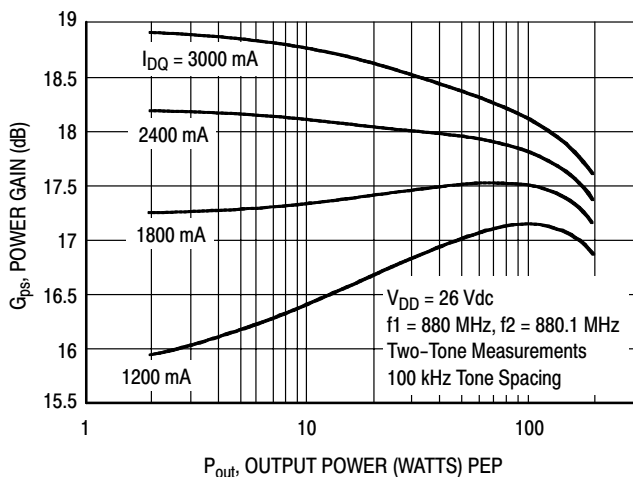

Figure 5. Two-Tone Power Gain versus Output Power

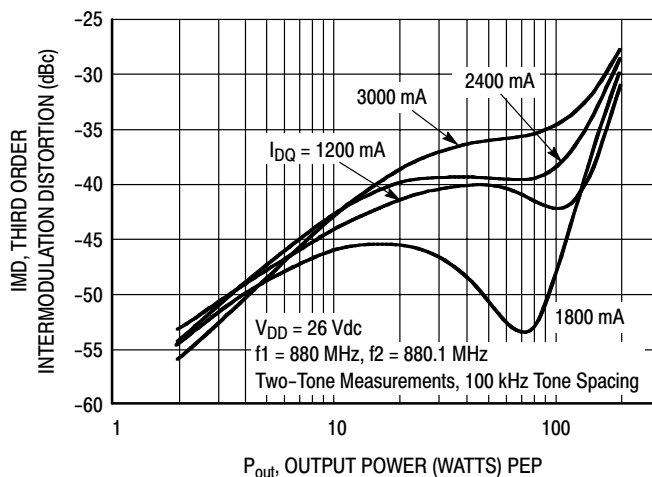

Figure 6. Third Order Intermodulation Distortion versus Output Power

TYPICAL CHARACTERISTICS

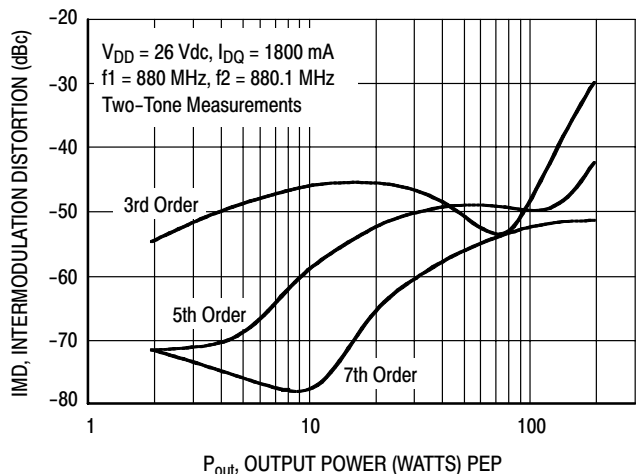

Figure 7. Intermodulation Distortion Products versus Output Power

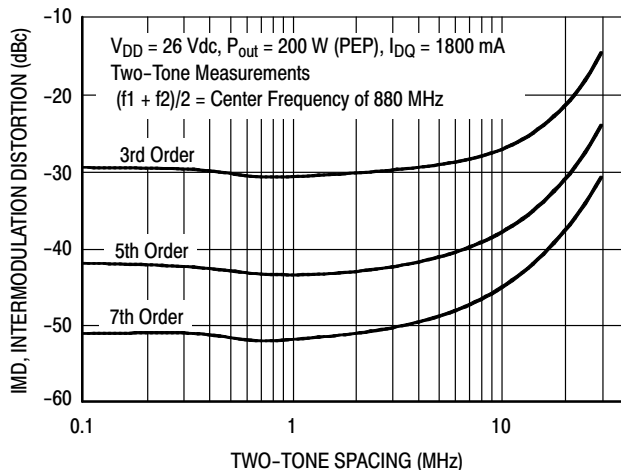

Figure 8. Intermodulation Distortion Products versus Tone Spacing

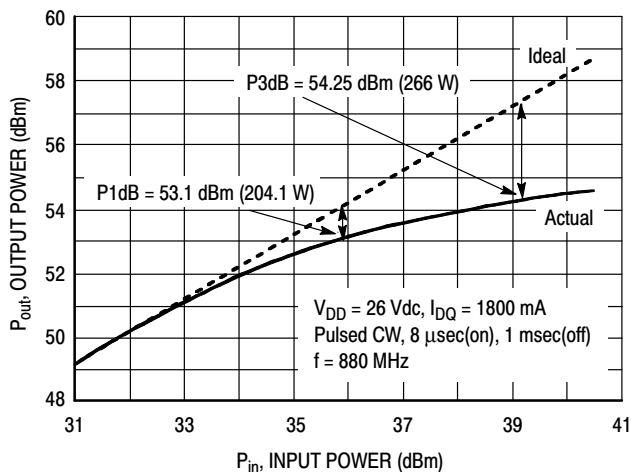

Figure 9. Pulse CW Output Power versus Input Power

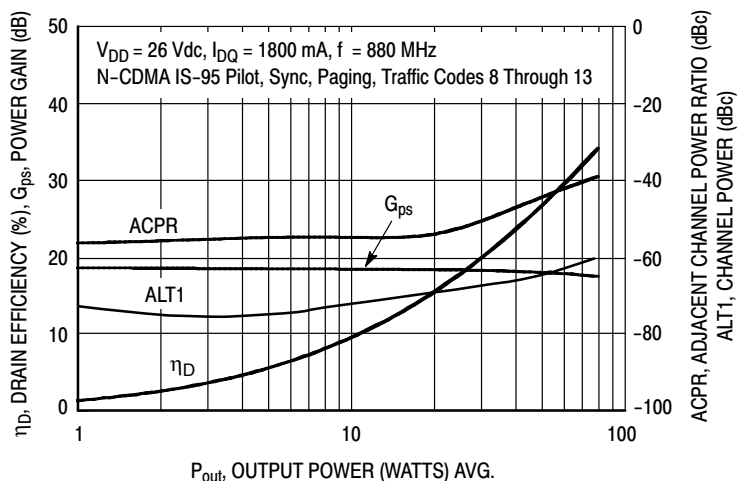

Figure 10. Single-Carrier N-CDMA ACPR, ALT1, Power Gain and Drain Efficiency versus Output Power

TYPICAL CHARACTERISTICS

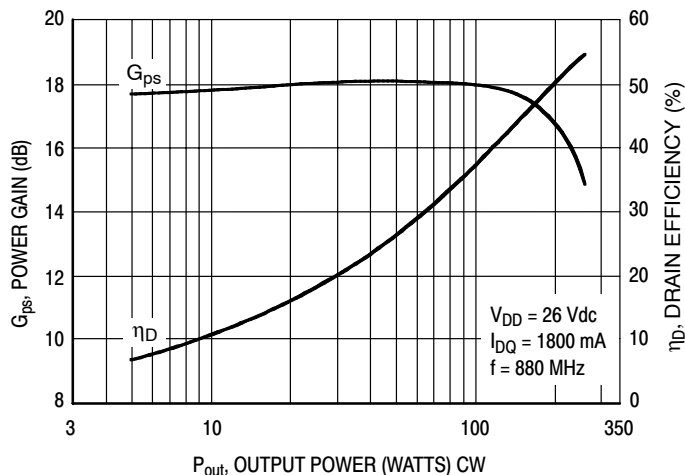

Figure 11. Power Gain and Drain Efficiency versus CW Output Power

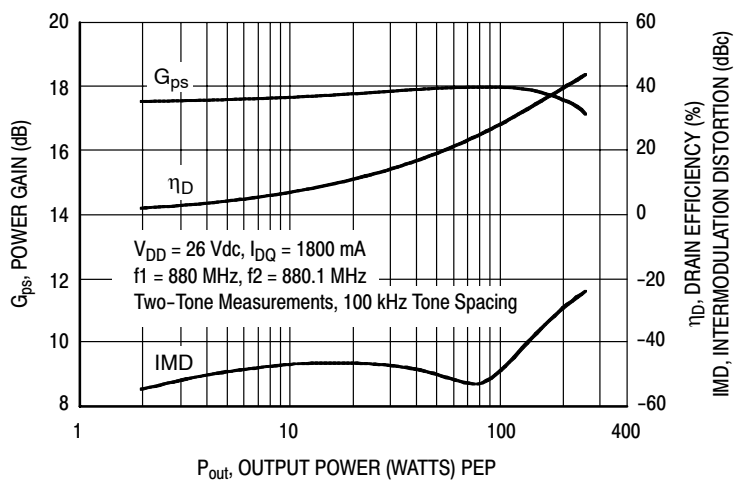

Figure 12. Power Gain, Efficiency and IMD versus Output Power

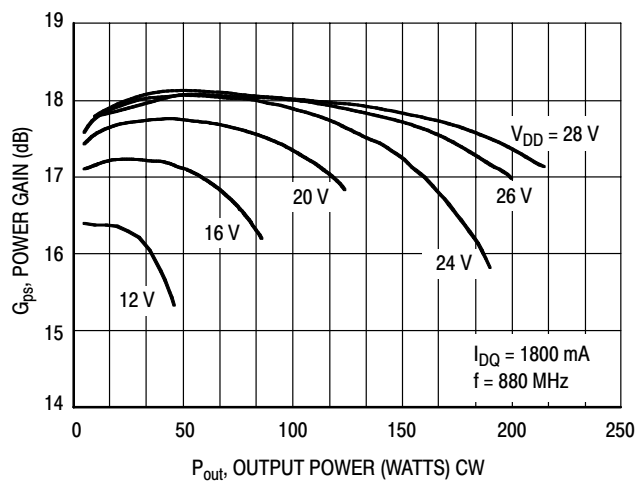
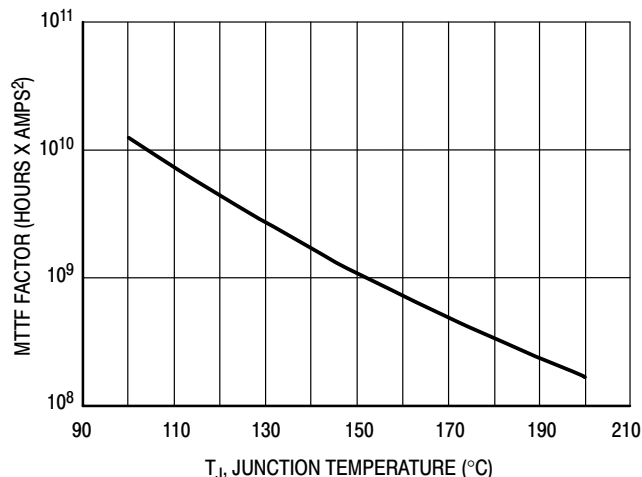

Figure 13. Power Gain versus Output Power

TYPICAL CHARACTERISTICS



This above graph displays calculated MTTF in hours x ampere² drain current. Life tests at elevated temperatures have correlated to better than $\pm 10\%$ of the theoretical prediction for metal failure. Divide MTTF factor by I_D^2 for MTTF in a particular application.

Figure 14. MTTF Factor versus Junction Temperature

N-CDMA TEST SIGNAL

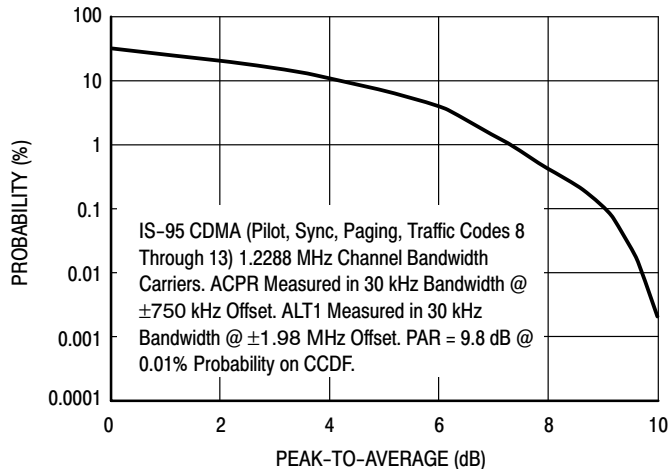

Figure 15. Single-Carrier CCDF N-CDMA

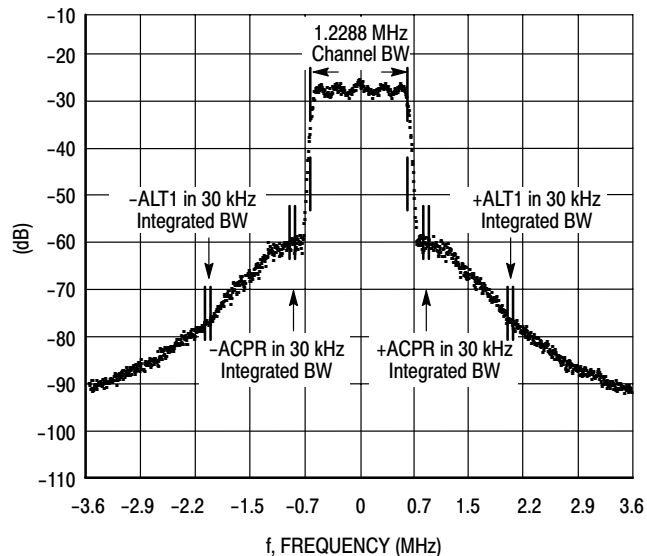
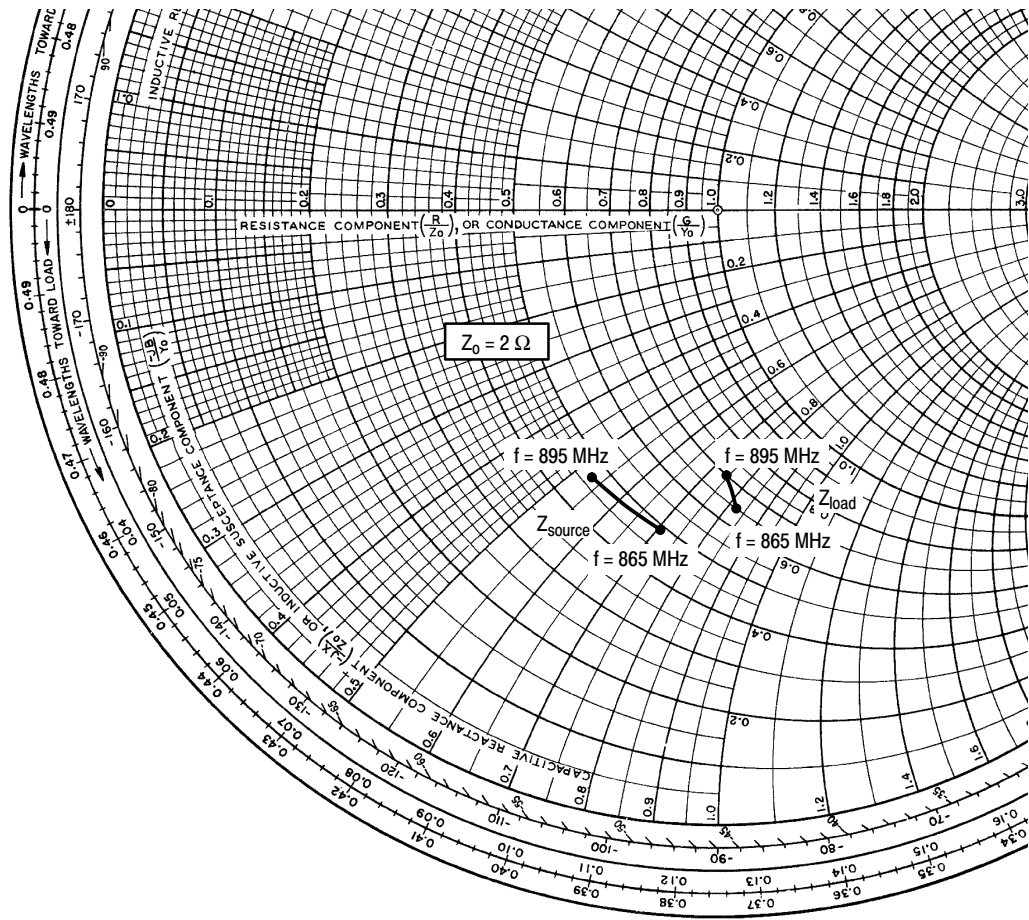

Figure 16. Single-Carrier N-CDMA Spectrum



$V_{DD} = 26 \text{ Vdc}$, $I_{DQ} = 2400 \text{ mA}$, $P_{out} = 40 \text{ W Avg.}$

f MHz	$Z_{source} \Omega$	$Z_{load} \Omega$
865	$0.98 - j1.41$	$1.30 - j1.66$
880	$0.96 - j1.23$	$1.36 - j1.58$
895	$0.94 - j1.06$	$1.40 - j1.50$

Z_{source} = Test circuit impedance as measured from gate to ground.

Z_{load} = Test circuit impedance as measured from drain to ground.

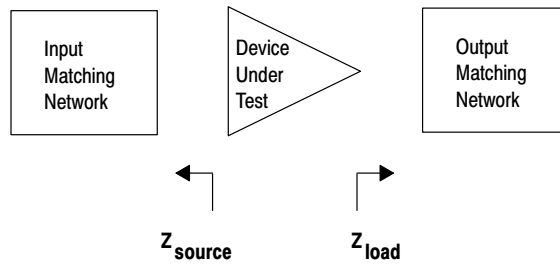
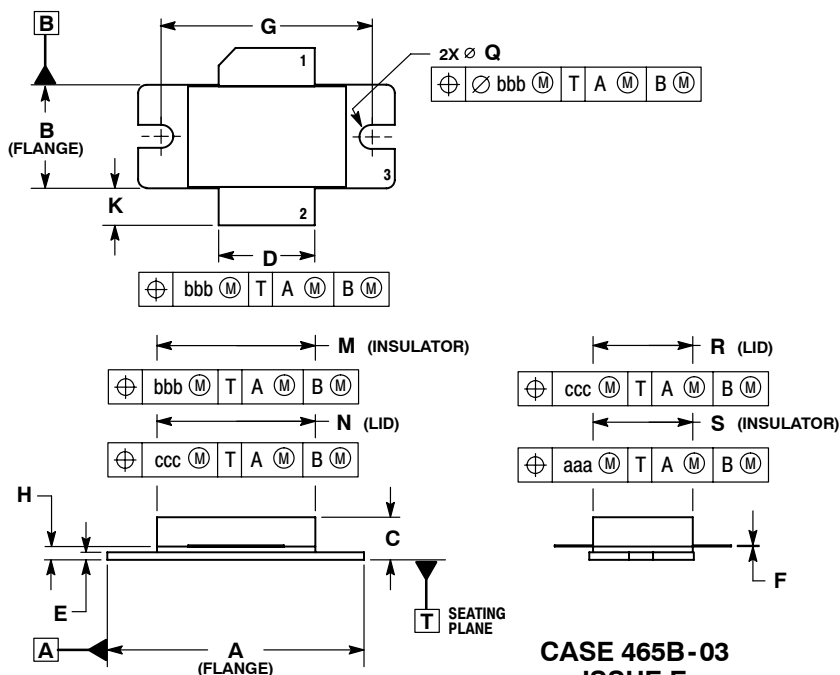

Figure 17. Series Equivalent Source and Load Impedance

NOTES

PACKAGE DIMENSIONS



**CASE 465B-03
ISSUE E
NI-880
MRF9200LR3**

- NOTES:
1. DIMENSIONING AND TOLERANCING PER ANSI Y14.5M-1994.
 2. CONTROLLING DIMENSION: INCH.
 3. DIMENSION H IS MEASURED 0.030 (0.762) AWAY FROM PACKAGE BODY.
 4. DELETED

DIM	INCHES		MILLIMETERS	
	MIN	MAX	MIN	MAX
A	1.335	1.345	33.91	34.16
B	0.535	0.545	13.6	13.8
C	0.147	0.200	3.73	5.08
D	0.495	0.505	12.57	12.83
E	0.035	0.045	0.89	1.14
F	0.003	0.006	0.08	0.15
G	1.100	BSC	27.94	BSC
H	0.057	0.067	1.45	1.70
K	0.170	0.210	4.32	5.33
M	0.872	0.888	22.15	22.55
N	0.871	0.889	19.30	22.60
Q	∅.118	∅.138	∅3.00	∅3.51
R	0.515	0.525	13.10	13.30
S	0.515	0.525	13.10	13.30
aaa	0.007 REF		0.178 REF	
bbb	0.010 REF		0.254 REF	
ccc	0.015 REF		0.381 REF	

- STYLE 1:
PIN 1. DRAIN
2. GATE
3. SOURCE

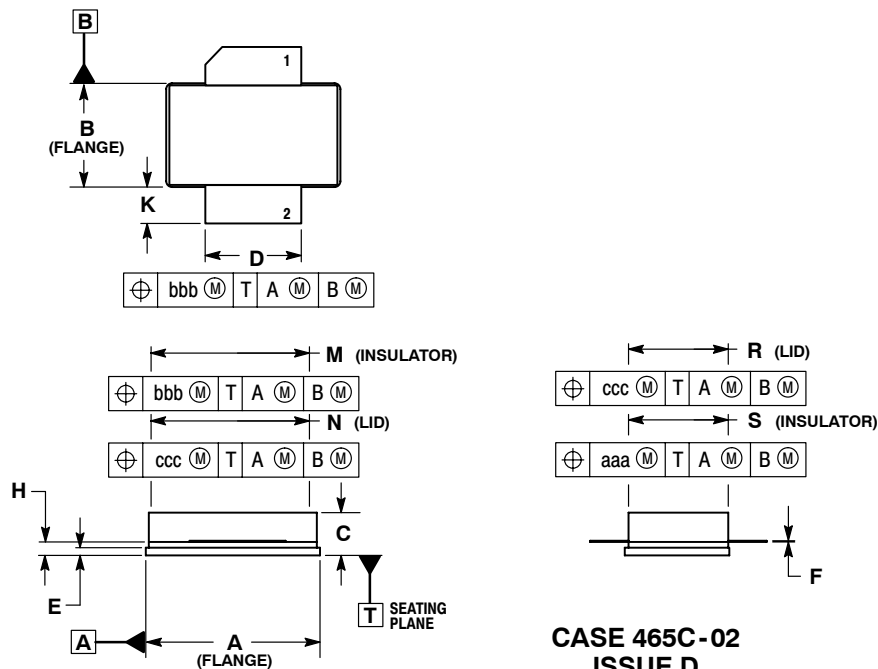

**CASE 465C-02
ISSUE D
NI-880S
MRF9200LSR3**

- NOTES:
1. DIMENSIONING AND TOLERANCING PER ANSI Y14.5M-1994.
 2. CONTROLLING DIMENSION: INCH.
 3. DIMENSION H IS MEASURED 0.030 (0.762) AWAY FROM PACKAGE BODY.

DIM	INCHES		MILLIMETERS	
	MIN	MAX	MIN	MAX
A	0.905	0.915	22.99	23.24
B	0.535	0.545	13.60	13.80
C	0.147	0.200	3.73	5.08
D	0.495	0.505	12.57	12.83
E	0.035	0.045	0.89	1.14
F	0.003	0.006	0.08	0.15
H	0.057	0.067	1.45	1.70
K	0.170	0.210	4.32	5.33
M	0.872	0.888	22.15	22.55
N	0.871	0.889	19.30	22.60
R	0.515	0.525	13.10	13.30
S	0.515	0.525	13.10	13.30
aaa	0.007 REF		0.178 REF	
bbb	0.010 REF		0.254 REF	
ccc	0.015 REF		0.381 REF	

- STYLE 1:
PIN 1. DRAIN
2. GATE
3. SOURCE

How to Reach Us:

Home Page:
www.freescale.com

E-mail:
support@freescale.com

USA/Europe or Locations Not Listed:
Freescale Semiconductor
Technical Information Center, CH370
1300 N. Alma School Road
Chandler, Arizona 85224
+1-800-521-6274 or +1-480-768-2130
support@freescale.com

Europe, Middle East, and Africa:
Freescale Halbleiter Deutschland GmbH
Technical Information Center
Schatzbogen 7
81829 Muenchen, Germany
+44 1296 380 456 (English)
+46 8 52200080 (English)
+49 89 92103 559 (German)
+33 1 69 35 48 48 (French)
support@freescale.com

Japan:
Freescale Semiconductor Japan Ltd.
Headquarters
ARCO Tower 15F
1-8-1, Shimo-Meguro, Meguro-ku,
Tokyo 153-0064
Japan
0120 191014 or +81 3 5437 9125
support.japan@freescale.com

Asia/Pacific:
Freescale Semiconductor Hong Kong Ltd.
Technical Information Center
2 Dai King Street
Tai Po Industrial Estate
Tai Po, N.T., Hong Kong
+800 2666 8080
support.asia@freescale.com

For Literature Requests Only:
Freescale Semiconductor Literature Distribution Center
P.O. Box 5405
Denver, Colorado 80217
1-800-441-2447 or 303-675-2140
Fax: 303-675-2150
LDCForFreescaleSemiconductor@hibbertgroup.com

Information in this document is provided solely to enable system and software implementers to use Freescale Semiconductor products. There are no express or implied copyright licenses granted hereunder to design or fabricate any integrated circuits or integrated circuits based on the information in this document.

Freescale Semiconductor reserves the right to make changes without further notice to any products herein. Freescale Semiconductor makes no warranty, representation or guarantee regarding the suitability of its products for any particular purpose, nor does Freescale Semiconductor assume any liability arising out of the application or use of any product or circuit, and specifically disclaims any and all liability, including without limitation consequential or incidental damages. "Typical" parameters that may be provided in Freescale Semiconductor data sheets and/or specifications can and do vary in different applications and actual performance may vary over time. All operating parameters, including "Typicals", must be validated for each customer application by customer's technical experts. Freescale Semiconductor does not convey any license under its patent rights nor the rights of others. Freescale Semiconductor products are not designed, intended, or authorized for use as components in systems intended for surgical implant into the body, or other applications intended to support or sustain life, or for any other application in which the failure of the Freescale Semiconductor product could create a situation where personal injury or death may occur. Should Buyer purchase or use Freescale Semiconductor products for any such unintended or unauthorized application, Buyer shall indemnify and hold Freescale Semiconductor and its officers, employees, subsidiaries, affiliates, and distributors harmless against all claims, costs, damages, and expenses, and reasonable attorney fees arising out of, directly or indirectly, any claim of personal injury or death associated with such unintended or unauthorized use, even if such claim alleges that Freescale Semiconductor was negligent regarding the design or manufacture of the part.

Freescale™ and the Freescale logo are trademarks of Freescale Semiconductor, Inc. All other product or service names are the property of their respective owners.
© Freescale Semiconductor, Inc. 2006. All rights reserved.

