

Glass Passivated Single-Phase Bridge Rectifier, 20A

KBJ2004 Thru KBJ2012

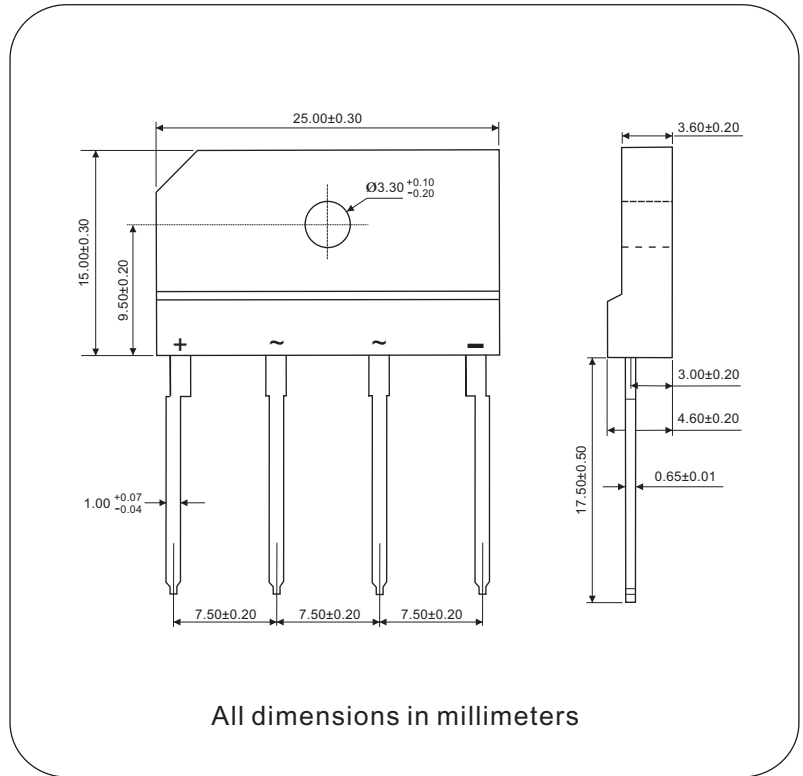
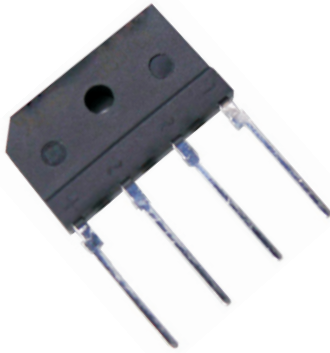

FEATURES

- UL recognition file number E320098
- Typical IR less than 2.0 μA
- High surge current capability
- Low thermal resistance
- Compliant to RoHS
- Isolation voltage up to 2500V

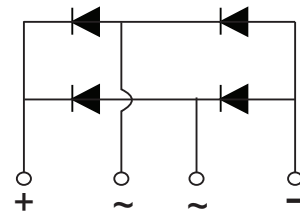

TYPICAL APPLICATIONS

General purpose use in AC/DC bridge full wave rectification for big power supply, field supply for DC motor, industrial automation applications.

ADVANTAGE

- International standard package
- Epoxy meets UL 94 V-O flammability rating
- Small volume, light weight
- Small thermal resistance
- High heat-conduction rate
- Low temperature rise
- High temperature soldering guaranteed : 260°C/10 second, 2.3kg tension force
- Weight: 4.0g (0.14 ozs)

PRIMARY CHARACTERISTICS	
$I_{F(AV)}$	20A
V_{RRM}	400V to 1200V
I_{FSM}	300A
I_R	5 μA
V_F	1.10V
$T_{Jmax.}$	150°C

Nell High Power Products

MAJOR RATINGS AND CHARACTERISTICS ($T_A = 25^\circ\text{C}$ unless otherwise noted)							
PARAMETER	SYMBOL	KBJ20					UNIT
		04	06	08	10	12	
Maximum repetitive peak reverse voltage	V_{RRM}	400	600	800	1000	1200	V
Peak reverse non-repetitive voltage	V_{RSM}	500	700	900	1100	1300	V
Maximum DC blocking voltage	V_{DC}	400	600	800	1000	1200	V
Maximum average forward rectified output current, $T_c = 85^\circ\text{C}$	$I_{F(AV)}$	20					A
Peak forward surge current single sine-wave superimposed on rated load	I_{FSM}	300					A
Rating (non-repetitive, for t greater than 1 ms and less than 8.3 ms) for fusing	I^2t	374					A ² s
RMS isolation voltage from case to leads	V_{ISO}	2500					V
Operating junction storage temperature range	T_J	-40 to 150					$^\circ\text{C}$
Storage temperature range	T_{STG}	-40 to 150					$^\circ\text{C}$

ELECTRICAL CHARACTERISTICS ($T_A = 25^\circ\text{C}$ unless otherwise noted)								
PARAMETER	TEST CONDITIONS	SYMBOL	KBJ20					UNIT
			04	06	08	10	12	
Maximum instantaneous forward drop per diode	$I_F = 10\text{A}$	V_F	1.10					V
Maximum reverse DC current at rated DC blocking voltage per diode	$T_A = 25^\circ\text{C}$	I_R	5					μA
	$T_A = 150^\circ\text{C}$		500					

THERMAL AND MECHANICAL ($T_A = 25^\circ\text{C}$ unless otherwise noted)								
PARAMETER	TEST CONDITIONS	SYMBOL	KBJ20					UNIT
			04	06	08	10	12	
Typical thermal resistance junction to case	Single-side heat dissipation, sine half wave	$R_{\theta JC}^{(1)}$	1.0					$^\circ\text{C}/\text{W}$
Mounting torque to heatsink M3 $\pm 10\%$	A mounting compound is recommended and the torque should be rechecked after a period of 3 hours to allow for the spread of the compound.		0.8					Nm
Approximate weight			4.0					g

Notes

(1) With heatsink, single side heat dissipation, half sine wave.

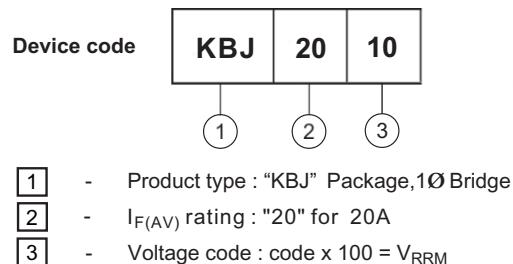

Fig.1 Derating curve for output rectified current

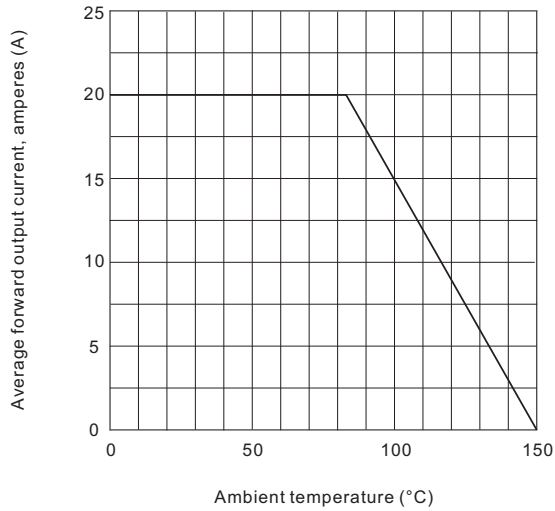

Fig.2 Maximum non-repetitive peak forward surge current per bridge element

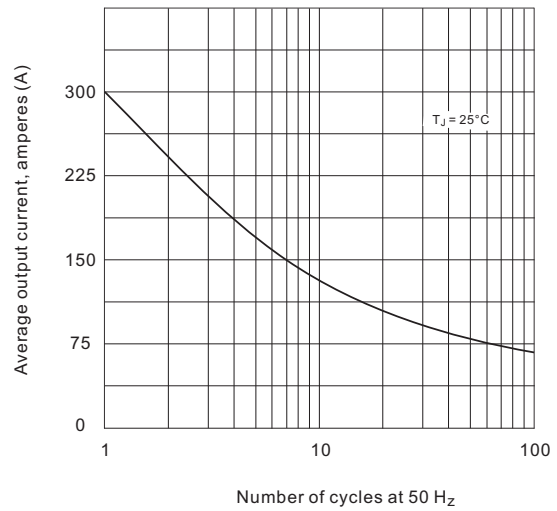

Fig.3 Typical reverse characteristics per bridge element

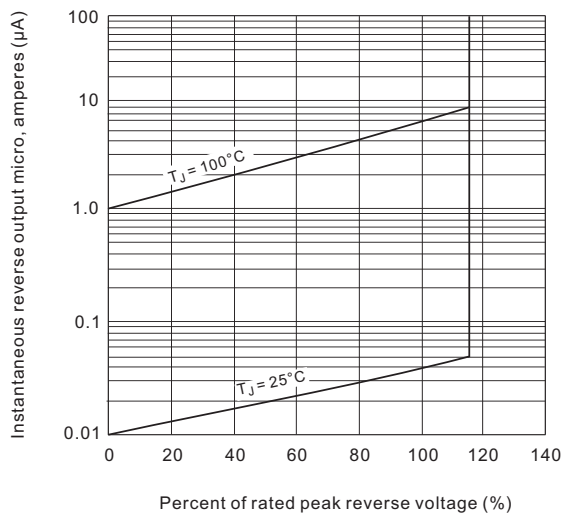

Fig.4 Typical forward characteristics per bridge element

