



# RF Power Field Effect Transistors

## N-Channel Enhancement-Mode Lateral MOSFETs

Designed for WiMAX base station applications with frequencies up to 2700 MHz. Suitable for WiMAX, WiBro, BWA, and OFDM multicarrier Class AB and Class C amplifier applications.

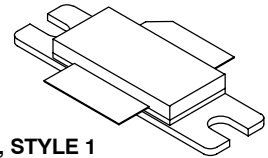
- Typical WiMAX Performance:  $V_{DD} = 28$  Volts,  $I_{DQ} = 1500$  mA,  $P_{out} = 23$  Watts Avg.,  $f = 2500$  and  $2700$  MHz, 802.16d, 64 QAM  $3/4$ , 4 bursts, 7 MHz Channel Bandwidth, Input Signal PAR = 9.5 dB @ 0.01% Probability on CCDF.  
Power Gain — 16.5 dB  
Drain Efficiency — 20%  
Device Output Signal PAR — 8.2 dB @ 0.01% Probability on CCDF  
ACPR @ 5.25 MHz Offset — -49 dBc in 0.5 MHz Channel Bandwidth
- Capable of Handling 10:1 VSWR, @ 32 Vdc, 2600 MHz, 105 Watts CW Output Power

### Features

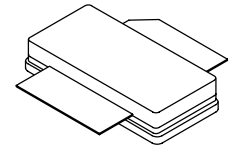
- Characterized with Series Equivalent Large-Signal Impedance Parameters
- Internally Matched for Ease of Use
- Integrated ESD Protection
- Greater Negative Gate-Source Voltage Range for Improved Class C Operation
- RoHS Compliant
- In Tape and Reel. R3 Suffix = 250 Units per 56 mm, 13 inch Reel.

**MRF7S27130HR3**  
**MRF7S27130HSR3**

**2500-2700 MHz, 23 W AVG., 28 V**  
**WiMAX**  
**LATERAL N-CHANNEL**  
**RF POWER MOSFETs**



**CASE 465-06, STYLE 1**  
**NI-780**  
**MRF7S27130HR3**



**CASE 465A-06, STYLE 1**  
**NI-780S**  
**MRF7S27130HSR3**

**Table 1. Maximum Ratings**

Rating	Symbol	Value	Unit
Drain-Source Voltage	$V_{DS}$	-0.5, +65	Vdc
Gate-Source Voltage	$V_{GS}$	-6.0, +10	Vdc
Operating Voltage	$V_{DD}$	32, +0	Vdc
Storage Temperature Range	$T_{stg}$	-65 to +150	°C
Case Operating Temperature	$T_C$	150	°C
Operating Junction Temperature (1,2)	$T_J$	225	°C
CW Operation @ $T_C = 25^\circ\text{C}$ Derate above $25^\circ\text{C}$	CW	150 0.83	W W/°C

**Table 2. Thermal Characteristics**

Characteristic	Symbol	Value (2,3)	Unit
Thermal Resistance, Junction to Case Case Temperature $80^\circ\text{C}$ , 104 W CW Case Temperature $69^\circ\text{C}$ , 23 W CW	$R_{\theta JC}$	0.32 0.36	°C/W

1. Continuous use at maximum temperature will affect MTTF.
2. MTTF calculator available at <http://www.freescale.com/rf>. Select Software & Tools/Development Tools/Calculators to access MTTF calculators by product.
3. Refer to AN1955, *Thermal Measurement Methodology of RF Power Amplifiers*. Go to <http://www.freescale.com/rf>. Select Documentation/Application Notes - AN1955.

**Table 3. ESD Protection Characteristics**

Test Methodology	Class
Human Body Model (per JESD22-A114)	1B (Minimum)
Machine Model (per EIA/JESD22-A115)	A (Minimum)
Charge Device Model (per JESD22-C101)	IV (Minimum)

**Table 4. Electrical Characteristics** ( $T_C = 25^\circ\text{C}$  unless otherwise noted)

Characteristic	Symbol	Min	Typ	Max	Unit
----------------	--------	-----	-----	-----	------

**Off Characteristics**

Zero Gate Voltage Drain Leakage Current ( $V_{DS} = 65\text{ Vdc}$ , $V_{GS} = 0\text{ Vdc}$ )	$I_{DSS}$	—	—	10	$\mu\text{Adc}$
Zero Gate Voltage Drain Leakage Current ( $V_{DS} = 28\text{ Vdc}$ , $V_{GS} = 0\text{ Vdc}$ )	$I_{DSS}$	—	—	1	$\mu\text{Adc}$
Gate-Source Leakage Current ( $V_{GS} = 5\text{ Vdc}$ , $V_{DS} = 0\text{ Vdc}$ )	$I_{GSS}$	—	—	1	$\mu\text{Adc}$

**On Characteristics**

Gate Threshold Voltage ( $V_{DS} = 10\text{ Vdc}$ , $I_D = 348\ \mu\text{Adc}$ )	$V_{GS(th)}$	1.2	2	2.7	Vdc
Gate Quiescent Voltage ( $V_{DS} = 28\text{ Vdc}$ , $I_D = 1500\text{ mAdc}$ )	$V_{GS(Q)}$	—	2.7	—	Vdc
Fixture Gate Quiescent Voltage <sup>(1)</sup> ( $V_{DD} = 28\text{ Vdc}$ , $I_D = 1500\text{ mAdc}$ , Measured in Functional Test)	$V_{GG(Q)}$	4	5.4	7	Vdc
Drain-Source On-Voltage ( $V_{GS} = 10\text{ Vdc}$ , $I_D = 3.4\text{ Adc}$ )	$V_{DS(on)}$	0.1	0.24	0.3	Vdc

**Dynamic Characteristics <sup>(2)</sup>**

Reverse Transfer Capacitance ( $V_{DS} = 28\text{ Vdc} \pm 30\text{ mV(rms)ac}$ @ 1 MHz, $V_{GS} = 0\text{ Vdc}$ )	$C_{rss}$	—	10.4	—	pF
Output Capacitance ( $V_{DS} = 28\text{ Vdc} \pm 30\text{ mV(rms)ac}$ @ 1 MHz, $V_{GS} = 0\text{ Vdc}$ )	$C_{oss}$	—	711	—	pF
Input Capacitance ( $V_{DS} = 28\text{ Vdc}$ , $V_{GS} = 0\text{ Vdc} \pm 30\text{ mV(rms)ac}$ @ 1 MHz)	$C_{iss}$	—	326	—	pF

**Functional Tests** (In Freescale Test Fixture, 50 ohm system)  $V_{DD} = 28\text{ Vdc}$ ,  $I_{DQ} = 1500\text{ mA}$ ,  $P_{out} = 23\text{ W Avg.}$ ,  $f = 2500\text{ MHz}$  and  $f = 2700\text{ MHz}$ , WiMAX Signal, 802.16d, 7 MHz Channel Bandwidth, 64 QAM <sup>3/4</sup>, 4 Bursts, PAR = 9.5 dB @ 0.01% Probability on CCDF. ACPR measured in 0.5 MHz Channel Bandwidth @  $\pm 0.25\text{ MHz}$  Offset.

Power Gain	$G_{ps}$	15	16.5	18.5	dB
Drain Efficiency	$\eta_D$	18	20	23	%
Output Peak-to-Average Ratio @ 0.01% Probability on CCDF	PAR	7.5	8.2	—	dB
Adjacent Channel Power Ratio	ACPR	—	-49	-46	dBc
Input Return Loss	IRL	—	-8	-5	dB

- $V_{GG} = 2 \times V_{GS(Q)}$ . Parameter measured on Freescale Test Fixture, due to resistive divider network on the board. Refer to Test Circuit schematic.
- Part internally matched both on input and output.

(continued)

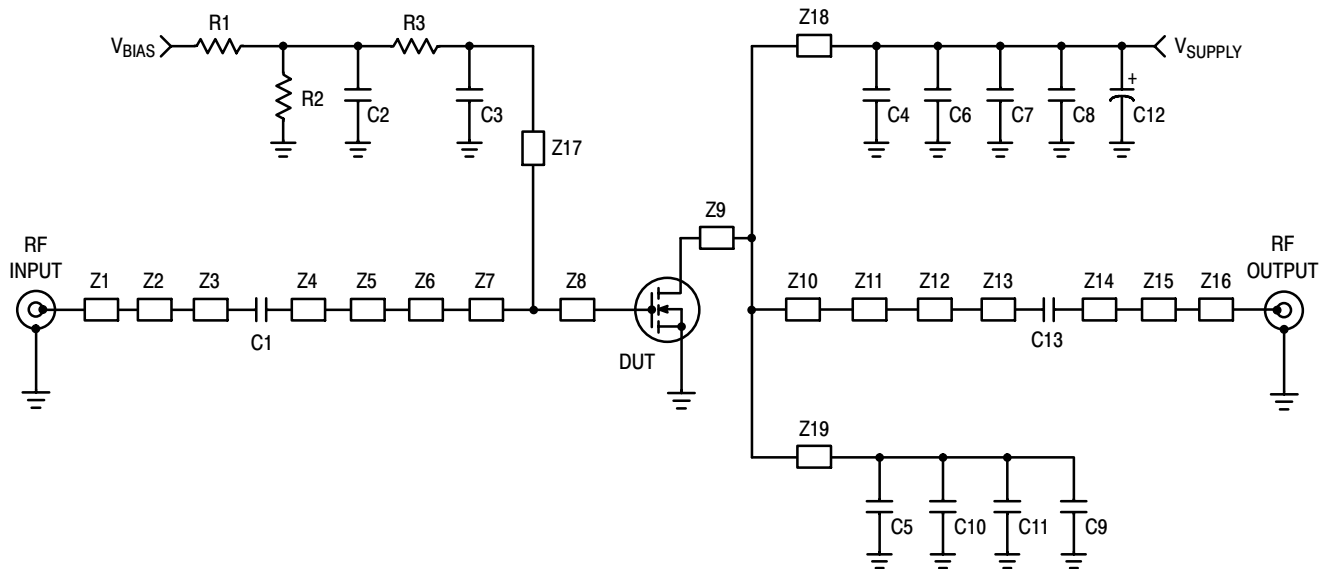
**Table 4. Electrical Characteristics** ( $T_C = 25^\circ\text{C}$  unless otherwise noted) (continued)

Characteristic	Symbol	Min	Typ	Max	Unit
<b>Typical Performances OFDM Signal</b> (In Freescale Test Fixture, 50 ohm system) $V_{DD} = 28\text{ Vdc}$ , $I_{DQ} = 1500\text{ mA}$ , $P_{out} = 23\text{ W Avg.}$ , $f = 2500\text{ MHz}$ and $f = 2700\text{ MHz}$ , WiMAX Signal, OFDM Single-Carrier, 7 MHz Channel Bandwidth, 64 QAM $3/4$ , 4 Bursts, PAR = 9.5 dB @ 0.01% Probability on CCDF.					
Mask System Type G @ $P_{out} = 23\text{ W Avg.}$ Point B at 3.5 MHz Offset Point C at 5 MHz Offset Point D at 7.4 MHz Offset Point E at 14 MHz Offset Point F at 17.5 MHz Offset	Mask	—	-27 -40 -44 -60 -60	—	dBc
Relative Constellation Error @ $P_{out} = 23\text{ W Avg.}$ <sup>(1)</sup>	RCE	—	-33	—	dB
Error Vector Magnitude <sup>(1)</sup> (Typical EVM Performance @ $P_{out} = 23\text{ W Avg.}$ with OFDM 802.16d Signal Call)	EVM	—	2.2	—	% rms

**Typical Performances** (In Freescale Test Fixture, 50 ohm system)  $V_{DD} = 28\text{ Vdc}$ ,  $I_{DQ} = 1500\text{ mA}$ , 2500-2700 MHz Bandwidth

Video Bandwidth @ 105 W PEP $P_{out}$ where $IM3 = -30\text{ dBc}$ (Tone Spacing from 100 kHz to VBW) $\Delta IMD3 = IMD3 @ \text{VBW frequency} - IMD3 @ 100\text{ kHz} < 1\text{ dBc}$ (both sidebands)	VBW	—	40	—	MHz
Gain Flatness in 200 MHz Bandwidth @ $P_{out} = 23\text{ W Avg.}$	$G_F$	—	1.2	—	dB
Average Deviation from Linear Phase in 200 MHz Bandwidth @ $P_{out} = 105\text{ W CW}$	$\Phi$	—	135	—	°
Average Group Delay @ $P_{out} = 105\text{ W CW}$ , $f = 2600\text{ MHz}$	Delay	—	1.5	—	ns
Part-to-Part Insertion Phase Variation @ $P_{out} = 105\text{ W CW}$ , $f = 2600\text{ MHz}$ , Six Sigma Window	$\Delta\Phi$	—	81.3	—	°
Gain Variation over Temperature ( $-30^\circ\text{C}$ to $+85^\circ\text{C}$ )	$\Delta G$	—	0.013	—	dB/°C
Output Power Variation over Temperature ( $-30^\circ\text{C}$ to $+85^\circ\text{C}$ )	$\Delta P_{1dB}$	—	0.01	—	dBm/°C

1.  $RCE = 20\text{Log}(EVM/100)$



Z1	0.320" x 0.084" Microstrip	Z11	0.251" x 0.084" Microstrip
Z2	0.380" x 0.240" Microstrip	Z12	0.160" x 0.162" Microstrip
Z3	0.046" x 0.084" Microstrip	Z13	0.566" x 0.084" Microstrip
Z4	0.273" x 0.084" Microstrip	Z14	0.059" x 0.084" Microstrip
Z5	0.360" x 0.600" Microstrip	Z15	0.080" x 0.123" Microstrip
Z6	0.260" x 0.394" Microstrip	Z16	0.583" x 0.084" Microstrip
Z7	0.145" x 0.922" Microstrip	Z17*	0.950" x 0.100" Microstrip
Z8	0.455" x 0.922" Microstrip	Z18, Z19*	0.560" x 0.100" Microstrip
Z9	0.106" x 0.716" Microstrip	PCB	Taconic TLX8 -0300, 0.030", $\epsilon_r = 2.55$
Z10	0.413" x 0.716" Microstrip		

\* Variable for tuning

**Figure 1. MRF7S27130HR3(HSR3) Test Circuit Schematic**

**Table 5. MRF7S27130HR3(HSR3) Test Circuit Component Designations and Values**

Part	Description	Part Number	Manufacturer
C1	2 pF Chip Capacitor	ATC100B2R0BT500XT	ATC
C2, C6, C7, C8, C9, C10, C11	10 $\mu$ F, 50 V Chip Capacitors	C5750X5R1H106M	TDK
C3	3 pF Chip Capacitor	ATC100B3R0BT500XT	ATC
C4, C5	3.6 pF Chip Capacitors	ATC100B3R6BT500XT	ATC
C12	470 $\mu$ F, 63 V Electrolytic Capacitor, Radial	EKME630ELL471MK25S	Nippon Chemi-Con
C13	5.6 pF Chip Capacitor	ATC100B5R6BT500XT	ATC
R1, R2	2 K $\Omega$ , 1/4 W Chip Resistors	CRCW12062001FKEA	Vishay
R3	10 $\Omega$ , 1/4 W Chip Resistor	CRCW120610R1FKEA	Vishay

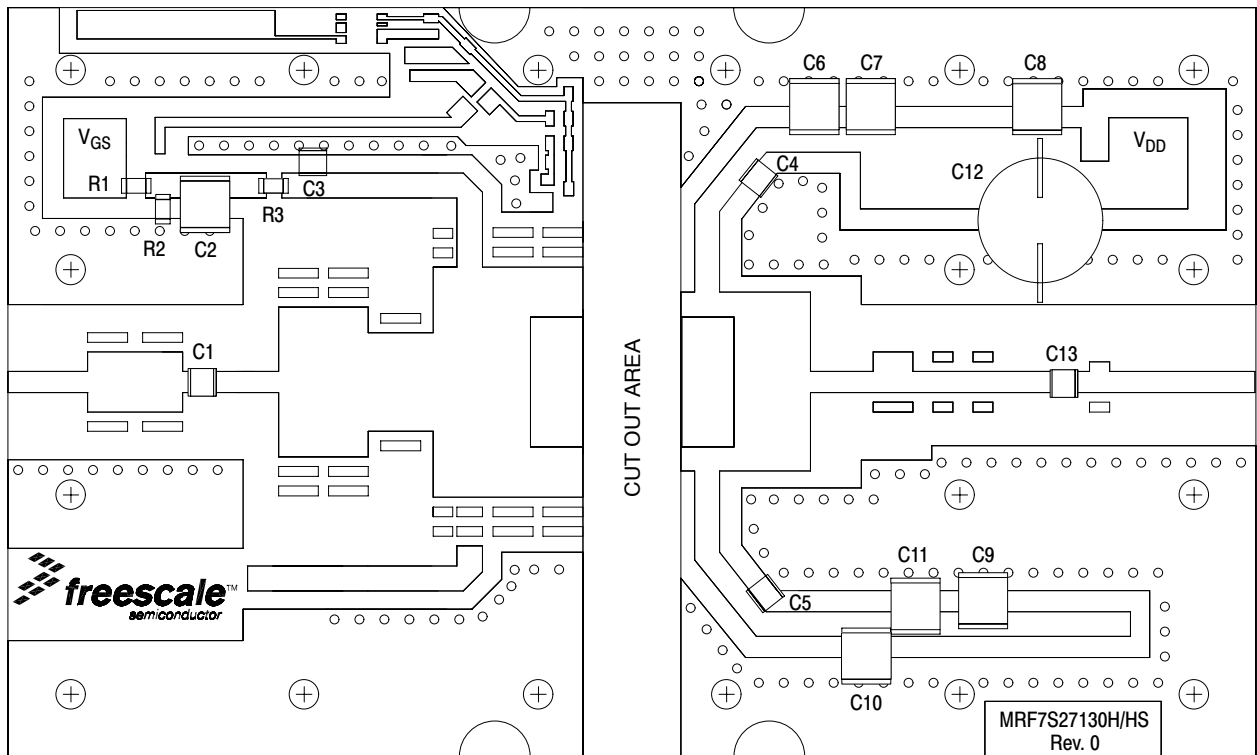


Figure 2. MRF7S27130HR3(HSR3) Test Circuit Component Layout

## TYPICAL CHARACTERISTICS

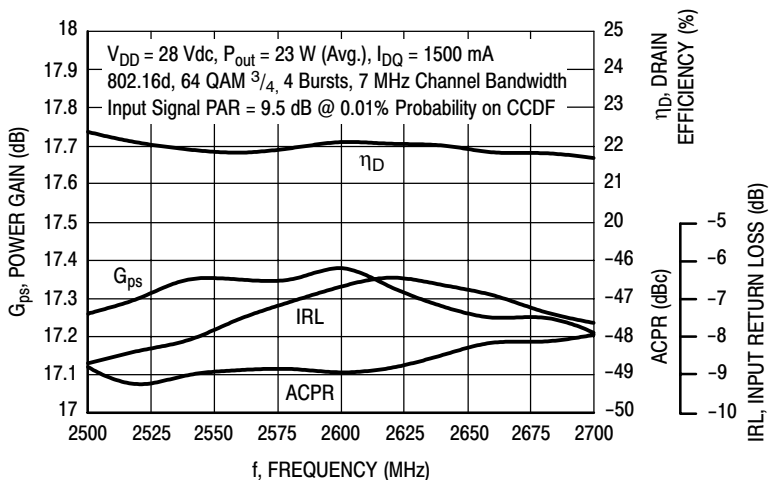


Figure 3. WiMAX Broadband Performance @  $P_{out} = 23 \text{ Watts Avg.}$

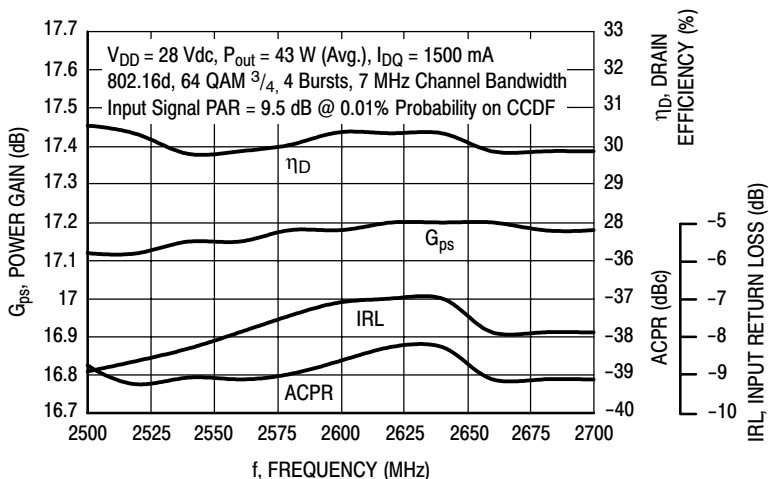


Figure 4. WiMAX Broadband Performance @  $P_{out} = 43 \text{ Watts Avg.}$

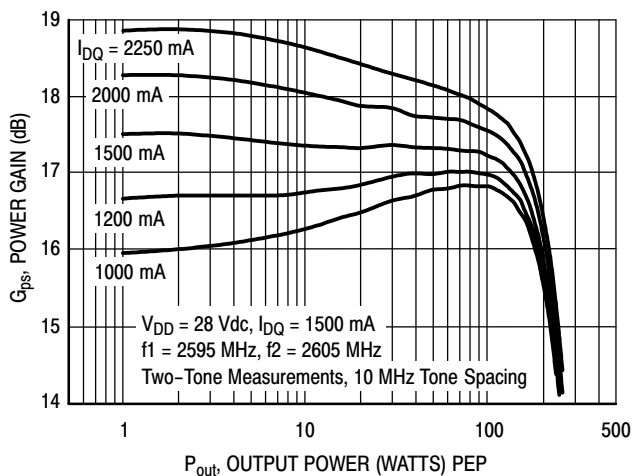


Figure 5. Two-Tone Power Gain versus Output Power

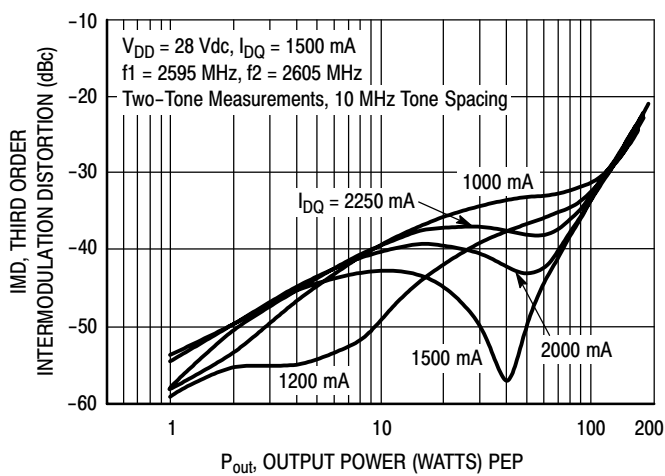


Figure 6. Third Order Intermodulation Distortion versus Output Power

## TYPICAL CHARACTERISTICS

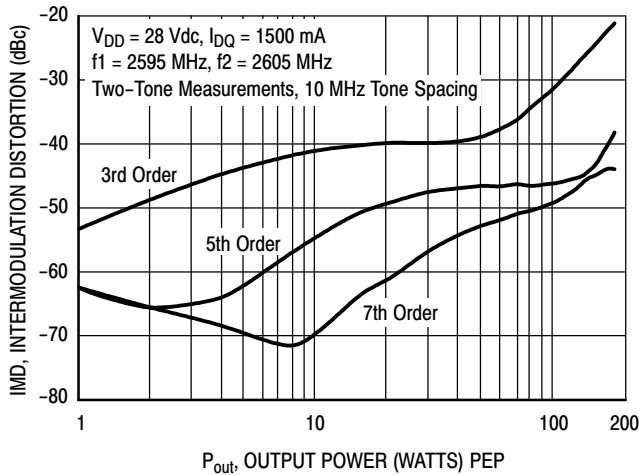


Figure 7. Intermodulation Distortion Products versus Output Power

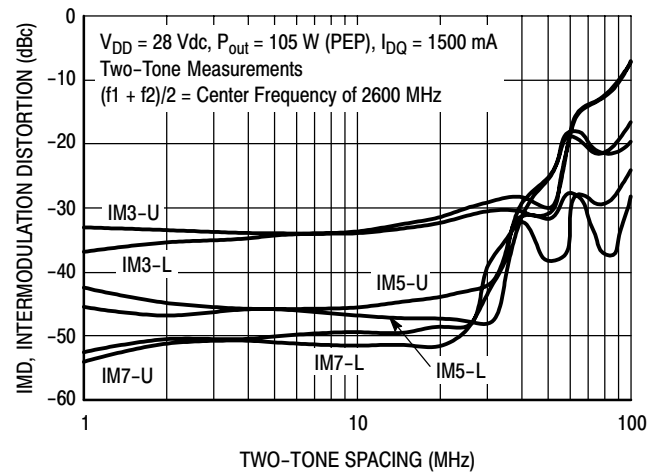


Figure 8. Intermodulation Distortion Products versus Tone Spacing

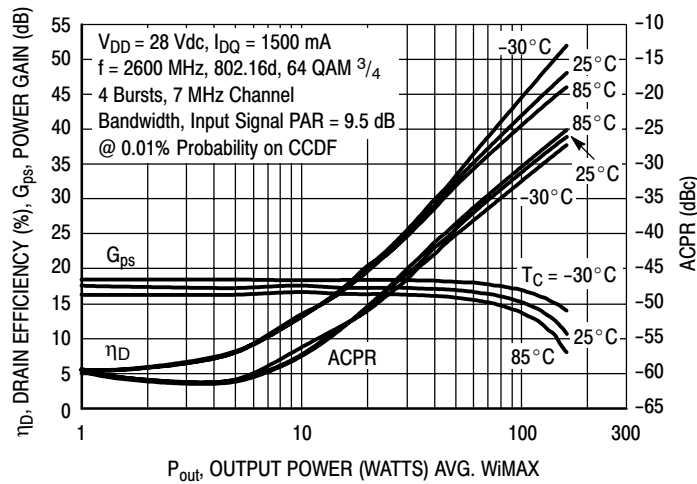


Figure 9. WiMAX, ACPR, Power Gain and Drain Efficiency versus Output Power

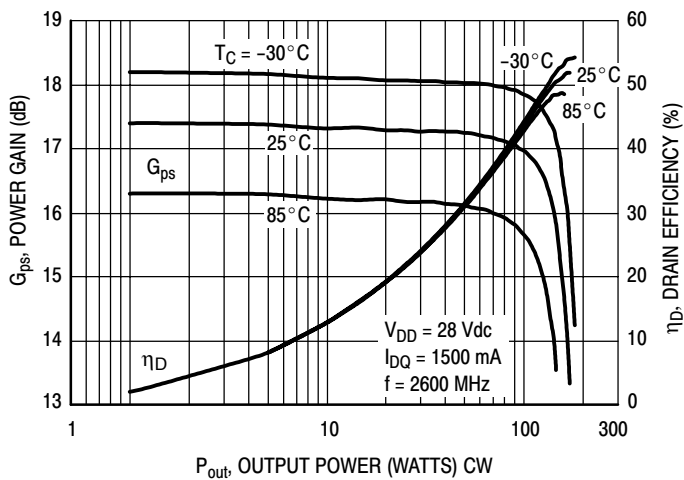


Figure 10. Power Gain and Drain Efficiency versus CW Output Power

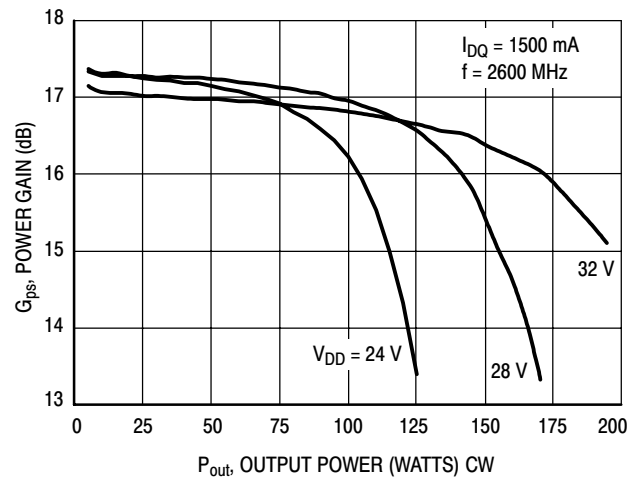
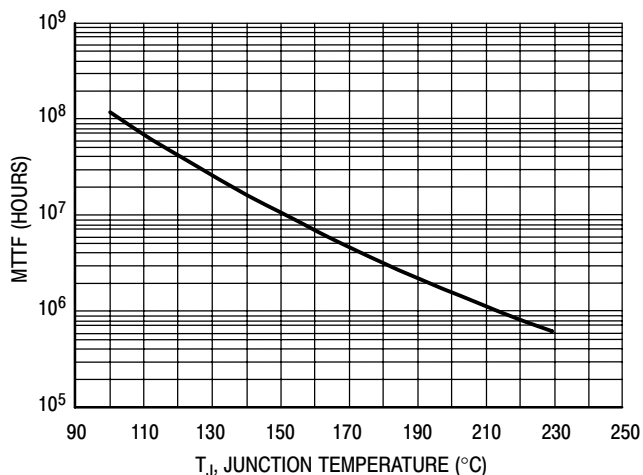


Figure 11. Power Gain versus Output Power

MRF7S27130HR3 MRF7S27130HSR3

## TYPICAL CHARACTERISTICS

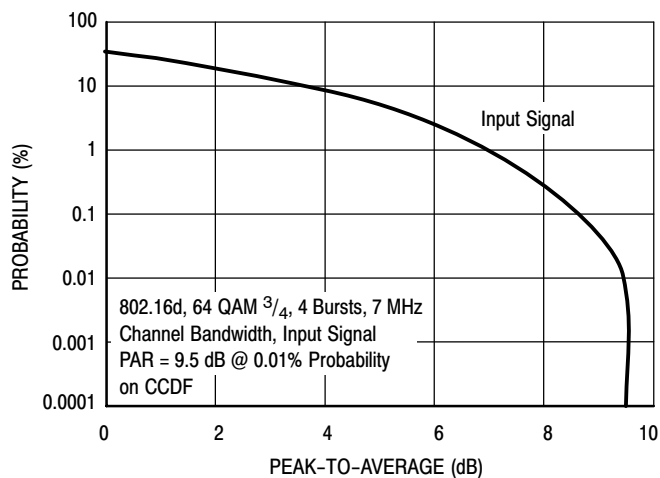


This above graph displays calculated MTTF in hours when the device is operated at  $V_{DD} = 28$  Vdc,  $P_{out} = 23$  W Avg., and  $\eta_D = 20\%$ .

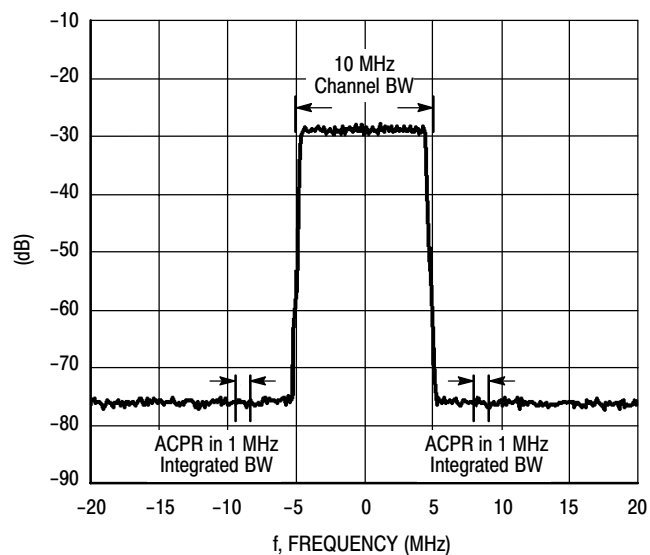
MTTF calculator available at <http://www.freescale.com/rf>. Select Software & Tools/Development Tools/Calculators to access MTTF calculators by product.

**Figure 12. MTTF versus Junction Temperature**

## WiMAX TEST SIGNAL

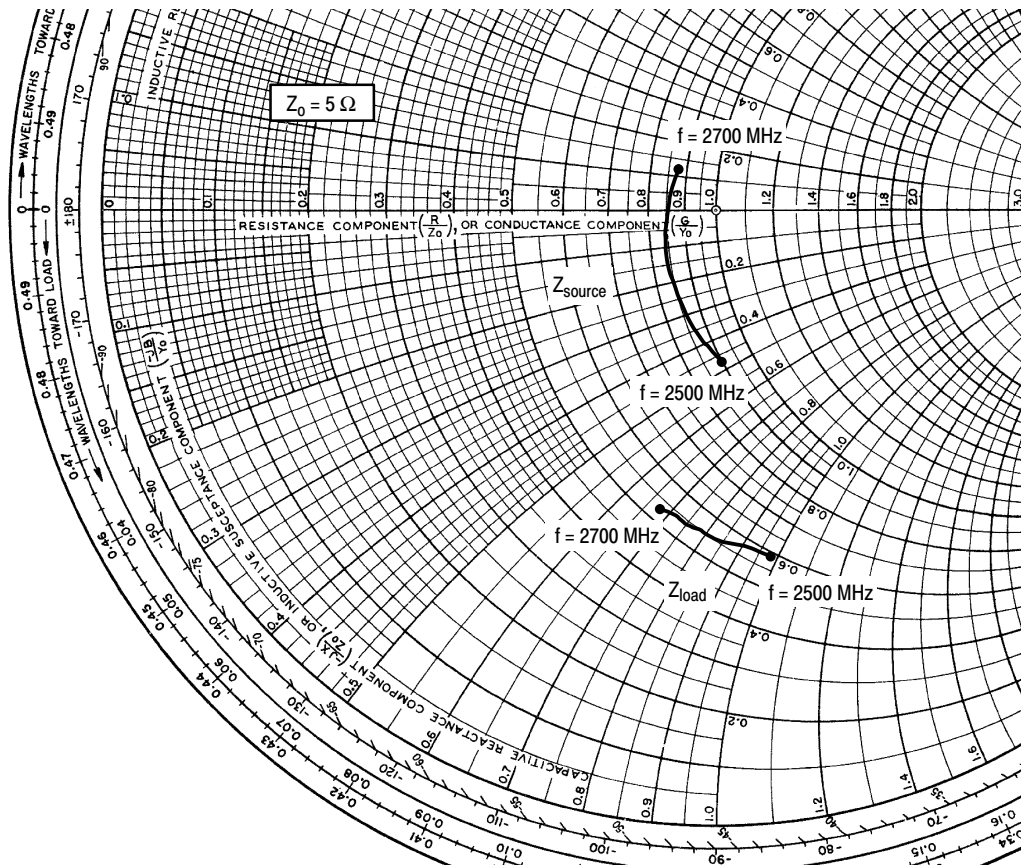


**Figure 13. OFDM 802.16d Test Signal**



**Figure 14. WiMAX Spectrum Mask Specifications**





$V_{DD} = 28 \text{ Vdc}$ ,  $I_{DQ} = 1500 \text{ mA}$ ,  $P_{out} = 23 \text{ W Avg.}$

f MHz	$Z_{source}$ $\Omega$	$Z_{load}$ $\Omega$
2500	4.499 - j2.335	2.936 - j4.876
2525	4.382 - j1.944	2.885 - j4.666
2550	4.294 - j1.567	2.838 - j4.467
2575	4.234 - j1.194	2.797 - j4.273
2600	4.209 - j0.820	2.763 - j4.084
2625	4.219 - j0.447	2.733 - j3.903
2650	4.248 - j0.090	2.706 - j3.732
2675	4.304 + j0.261	2.678 - j3.570
2700	4.390 + j0.612	2.652 - j3.410

$Z_{source}$  = Test circuit impedance as measured from gate to ground.

$Z_{load}$  = Test circuit impedance as measured from drain to ground.

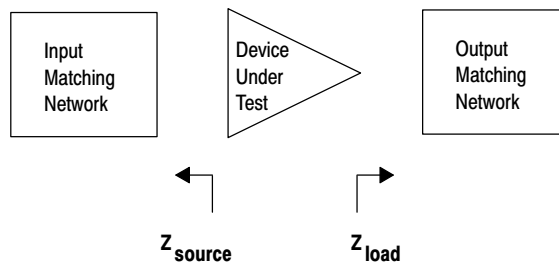
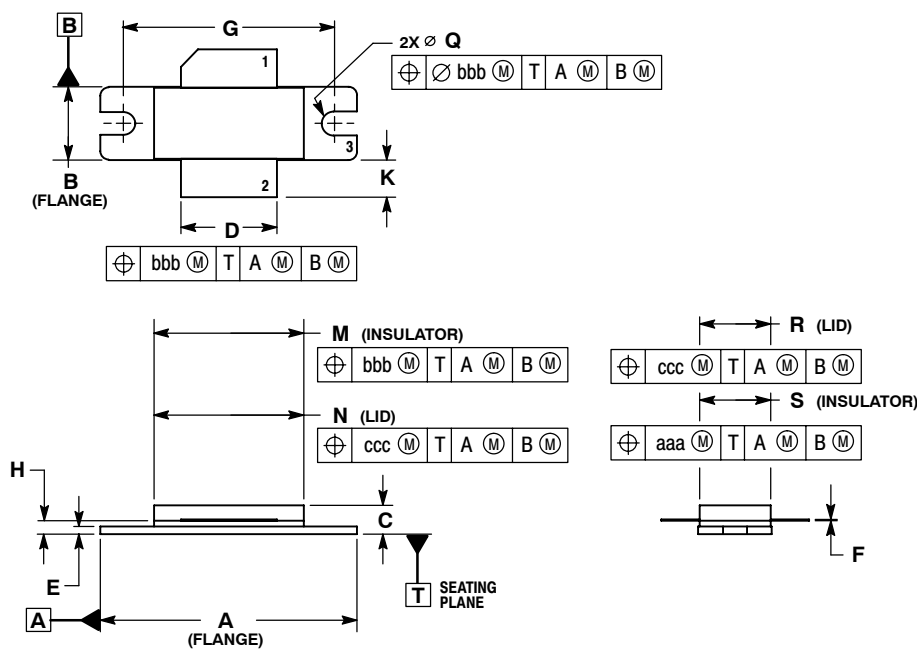


Figure 15. Series Equivalent Source and Load Impedance

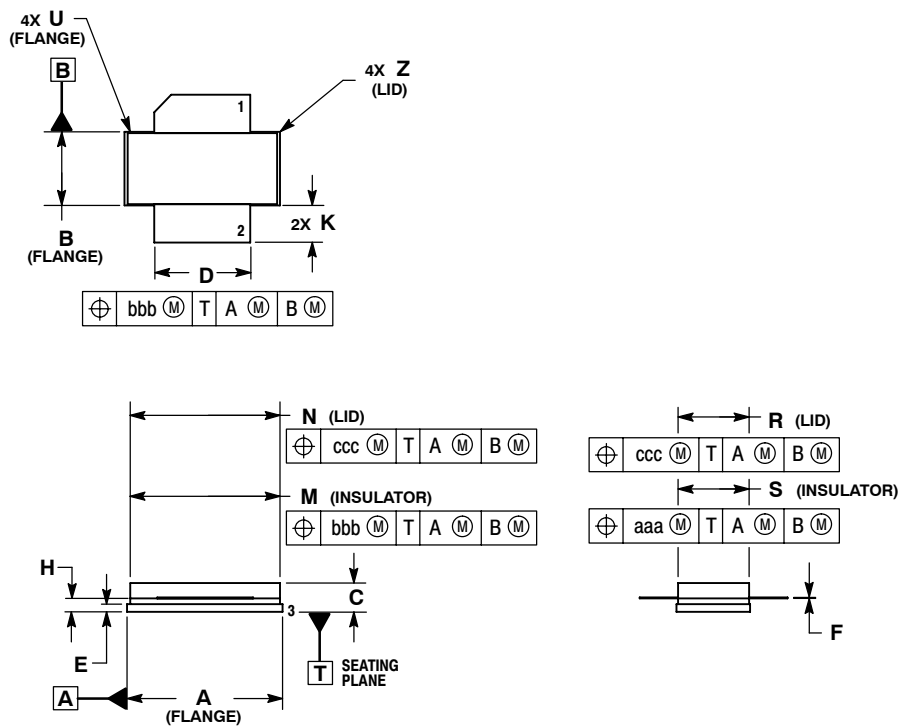
## PACKAGE DIMENSIONS



- NOTES:
1. DIMENSIONING AND TOLERANCING PER ANSI Y14.5M-1994.
  2. CONTROLLING DIMENSION: INCH.
  3. DELETED
  4. DIMENSION H IS MEASURED 0.030 (0.762) AWAY FROM PACKAGE BODY.

**CASE 465-06  
ISSUE G  
NI-780  
MRF7S27130HR3**

- STYLE 1:  
PIN 1. DRAIN  
2. GATE  
3. SOURCE



- NOTES:
1. DIMENSIONING AND TOLERANCING PER ANSI Y14.5M-1994.
  2. CONTROLLING DIMENSION: INCH.
  3. DELETED
  4. DIMENSION H IS MEASURED 0.030 (0.762) AWAY FROM PACKAGE BODY.

**CASE 465A-06  
ISSUE H  
NI-780S  
MRF7S27130HSR3**

- STYLE 1:  
PIN 1. DRAIN  
2. GATE  
5. SOURCE

MRF7S27130HR3 MRF7S27130HSR3

## PRODUCT DOCUMENTATION

Refer to the following documents to aid your design process.

### Application Notes

- AN1955: Thermal Measurement Methodology of RF Power Amplifiers

### Engineering Bulletins

- EB212: Using Data Sheet Impedances for RF LDMOS Devices

## REVISION HISTORY

The following table summarizes revisions to this document.

Revision	Date	Description
0	Sept. 2007	<ul style="list-style-type: none"><li>• Initial Release of Data Sheet</li></ul>
1	Dec. 2008	<ul style="list-style-type: none"><li>• Modified Fig. 13 to display Input Signal only, p. 8</li><li>• Updated Fig. 14, WiMAX Spectrum Mask Specification, to reflect the distortion free input test signal versus the distortion loaded output signal, p. 8</li></ul>

## **How to Reach Us:**

### **Home Page:**

[www.freescale.com](http://www.freescale.com)

### **Web Support:**

<http://www.freescale.com/support>

### **USA/Europe or Locations Not Listed:**

Freescale Semiconductor, Inc.  
Technical Information Center, EL516  
2100 East Elliot Road  
Tempe, Arizona 85284  
1-800-521-6274 or +1-480-768-2130  
[www.freescale.com/support](http://www.freescale.com/support)

### **Europe, Middle East, and Africa:**

Freescale Halbleiter Deutschland GmbH  
Technical Information Center  
Schatzbogen 7  
81829 Muenchen, Germany  
+44 1296 380 456 (English)  
+46 8 52200080 (English)  
+49 89 92103 559 (German)  
+33 1 69 35 48 48 (French)  
[www.freescale.com/support](http://www.freescale.com/support)

### **Japan:**

Freescale Semiconductor Japan Ltd.  
Headquarters  
ARCO Tower 15F  
1-8-1, Shimo-Meguro, Meguro-ku,  
Tokyo 153-0064  
Japan  
0120 191014 or +81 3 5437 9125  
[support.japan@freescale.com](mailto:support.japan@freescale.com)

### **Asia/Pacific:**

Freescale Semiconductor China Ltd.  
Exchange Building 23F  
No. 118 Jianguo Road  
Chaoyang District  
Beijing 100022  
China  
+86 10 5879 8000  
[support.asia@freescale.com](mailto:support.asia@freescale.com)

### **For Literature Requests Only:**

Freescale Semiconductor Literature Distribution Center  
P.O. Box 5405  
Denver, Colorado 80217  
1-800-441-2447 or +1-303-675-2140  
Fax: +1-303-675-2150  
[LDCForFreescaleSemiconductor@hibbertgroup.com](mailto:LDCForFreescaleSemiconductor@hibbertgroup.com)

Information in this document is provided solely to enable system and software implementers to use Freescale Semiconductor products. There are no express or implied copyright licenses granted hereunder to design or fabricate any integrated circuits or integrated circuits based on the information in this document.

Freescale Semiconductor reserves the right to make changes without further notice to any products herein. Freescale Semiconductor makes no warranty, representation or guarantee regarding the suitability of its products for any particular purpose, nor does Freescale Semiconductor assume any liability arising out of the application or use of any product or circuit, and specifically disclaims any and all liability, including without limitation consequential or incidental damages. "Typical" parameters that may be provided in Freescale Semiconductor data sheets and/or specifications can and do vary in different applications and actual performance may vary over time. All operating parameters, including "Typicals", must be validated for each customer application by customer's technical experts. Freescale Semiconductor does not convey any license under its patent rights nor the rights of others. Freescale Semiconductor products are not designed, intended, or authorized for use as components in systems intended for surgical implant into the body, or other applications intended to support or sustain life, or for any other application in which the failure of the Freescale Semiconductor product could create a situation where personal injury or death may occur. Should Buyer purchase or use Freescale Semiconductor products for any such unintended or unauthorized application, Buyer shall indemnify and hold Freescale Semiconductor and its officers, employees, subsidiaries, affiliates, and distributors harmless against all claims, costs, damages, and expenses, and reasonable attorney fees arising out of, directly or indirectly, any claim of personal injury or death associated with such unintended or unauthorized use, even if such claim alleges that Freescale Semiconductor was negligent regarding the design or manufacture of the part.

Freescale™ and the Freescale logo are trademarks of Freescale Semiconductor, Inc. All other product or service names are the property of their respective owners.

© Freescale Semiconductor, Inc. 2007-2008. All rights reserved.

