

**RADIATION HARDENED  
 POWER MOSFET  
 THRU-HOLE (SMD-2)**

**IRHNA57260SE  
 JANSR2N7473U2  
 200V, N CHANNEL  
 REF:MIL-PRF-19500/684**



**Product Summary**

Part Number	Radiation Level	RDS(on)	ID	QPL Part Number
IRHNA57260SE	100K Rads (Si)	0.038Ω	53.5A	JANSR2N7473U2

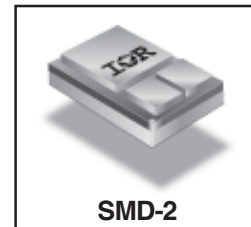

International Rectifier's R5™ technology provides high performance power MOSFETs for space applications. These devices have been characterized for Single Event Effects (SEE) with useful performance up to an LET of 80 (MeV/(mg/cm<sup>2</sup>)). The combination of low RDS(on) and low gate charge reduces the power losses in switching applications such as DC to DC converters and motor control. These devices retain all of the well established advantages of MOSFETs such as voltage control, fast switching, ease of paralleling and temperature stability of electrical parameters.

**Features:**

- Single Event Effect (SEE) Hardened
- Ultra Low RDS(on)
- Low Total Gate Charge
- Simple Drive Requirements
- Ease of Paralleling
- Hermetically Sealed
- Surface Mount
- Ceramic Package
- Light Weight

**Absolute Maximum Ratings**

**Pre-Irradiation**

	Parameter		Units
ID @ VGS = 12V, TC = 25°C	Continuous Drain Current	53.5	A
ID @ VGS = 12V, TC = 100°C	Continuous Drain Current	34	
IDM	Pulsed Drain Current ①	214	
PD @ TC = 25°C	Max. Power Dissipation	250	W
	Linear Derating Factor	2.0	W/°C
VGS	Gate-to-Source Voltage	±20	V
EAS	Single Pulse Avalanche Energy ②	380	mJ
IAR	Avalanche Current ①	53.5	A
EAR	Repetitive Avalanche Energy ①	25	mJ
dv/dt	Peak Diode Recovery dv/dt ③	9.2	V/ns
TJ	Operating Junction	-55 to 150	°C
TSTG	Storage Temperature Range		
	Pckg. Mounting Surface Temp.	300 (for 5s)	
	Weight	3.3 (Typical)	g

For footnotes refer to the last page

**Electrical Characteristics @ T<sub>j</sub> = 25°C (Unless Otherwise Specified)**

	Parameter	Min	Typ	Max	Units	Test Conditions
BV <sub>DSS</sub>	Drain-to-Source Breakdown Voltage	200	—	—	V	V <sub>GS</sub> = 0V, I <sub>D</sub> = 1.0mA
ΔBV <sub>DSS</sub> /ΔT <sub>J</sub>	Temperature Coefficient of Breakdown Voltage	—	0.26	—	V/°C	Reference to 25°C, I <sub>D</sub> = 1.0mA
R <sub>DS(on)</sub>	Static Drain-to-Source On-State Resistance	—	—	0.038	Ω	V <sub>GS</sub> = 12V, I <sub>D</sub> = 34A ④
V <sub>GS(th)</sub>	Gate Threshold Voltage	2.5	—	4.5	V	V <sub>DS</sub> = V <sub>GS</sub> , I <sub>D</sub> = 1.0mA
g <sub>fs</sub>	Forward Transconductance	35	—	—	S (r̄)	V <sub>DS</sub> > 15V, I <sub>DS</sub> = 34A ④
I <sub>DSS</sub>	Zero Gate Voltage Drain Current	—	—	10	μA	V <sub>DS</sub> = 160V, V <sub>GS</sub> = 0V
		—	—	25		V <sub>DS</sub> = 160V, V <sub>GS</sub> = 0V, T <sub>J</sub> = 125°C
I <sub>GSS</sub>	Gate-to-Source Leakage Forward	—	—	100	nA	V <sub>GS</sub> = 20V
I <sub>GSS</sub>	Gate-to-Source Leakage Reverse	—	—	-100		V <sub>GS</sub> = -20V
Q <sub>g</sub>	Total Gate Charge	—	—	155	nC	V <sub>GS</sub> = 12V, I <sub>D</sub> = 53.5A V <sub>DS</sub> = 100V
Q <sub>gs</sub>	Gate-to-Source Charge	—	—	45		
Q <sub>gd</sub>	Gate-to-Drain ('Miller') Charge	—	—	75		
t <sub>d(on)</sub>	Turn-On Delay Time	—	—	35	ns	V <sub>DD</sub> = 100V, I <sub>D</sub> = 53.5A, V <sub>GS</sub> = 12V, R <sub>G</sub> = 2.35Ω
t <sub>r</sub>	Rise Time	—	—	125		
t <sub>d(off)</sub>	Turn-Off Delay Time	—	—	80		
t <sub>f</sub>	Fall Time	—	—	50		
L <sub>S</sub> + L <sub>D</sub>	Total Inductance	—	4.0	—	nH	Measured from the center of drain pad to center of source pad
C <sub>iss</sub>	Input Capacitance	—	6044	—	pF	V <sub>GS</sub> = 0V, V <sub>DS</sub> = 25V f = 1.0MHz
C <sub>oss</sub>	Output Capacitance	—	913	—		
C <sub>rss</sub>	Reverse Transfer Capacitance	—	65	—		

**Source-Drain Diode Ratings and Characteristics**

	Parameter	Min	Typ	Max	Units	Test Conditions
I <sub>S</sub>	Continuous Source Current (Body Diode)	—	—	53.5	A	
I <sub>SM</sub>	Pulse Source Current (Body Diode) ①	—	—	214		
V <sub>SD</sub>	Diode Forward Voltage	—	—	1.2	V	T <sub>j</sub> = 25°C, I <sub>S</sub> = 53.5A, V <sub>GS</sub> = 0V ④
t <sub>rr</sub>	Reverse Recovery Time	—	—	450	nS	T <sub>j</sub> = 25°C, I <sub>F</sub> = 53.5A, di/dt ≤ 100A/μs
Q <sub>RR</sub>	Reverse Recovery Charge	—	—	7.0	μC	V <sub>DD</sub> ≤ 50V ④
t <sub>on</sub>	Forward Turn-On Time	Intrinsic turn-on time is negligible. Turn-on speed is substantially controlled by L <sub>S</sub> + L <sub>D</sub> .				

**Thermal Resistance**

	Parameter	Min	Typ	Max	Units	Test Conditions
R <sub>thJC</sub>	Junction-to-Case	—	—	0.5	°C/W	soldered to a 2" square copper-clad board
R <sub>thJ-PCB</sub>	Junction-to-PC board	—	1.6	—		

**Note:** Corresponding Spice and Saber models are available on International Rectifier Website.

For footnotes refer to the last page

## Radiation Characteristics

IRHNA57260SE, JANSR2N7473U2

International Rectifier Radiation Hardened MOSFETs are tested to verify their radiation hardness capability. The hardness assurance program at International Rectifier is comprised of two radiation environments. Every manufacturing lot is tested for total ionizing dose (per notes 5 and 6) using the TO-3 package. Both pre- and post-irradiation performance are tested and specified using the same drive circuitry and test conditions in order to provide a direct comparison.

**Table 1. Electrical Characteristics @ Tj = 25°C, Post Total Dose Irradiation ⑤⑥**

	Parameter	100K Rads (Si)		Units	Test Conditions
		Min	Max		
BV <sub>DSS</sub>	Drain-to-Source Breakdown Voltage	200	—	V	V <sub>GS</sub> = 0V, I <sub>D</sub> = 1.0mA
V <sub>GS(th)</sub>	Gate Threshold Voltage ④	2.0	4.5		V <sub>GS</sub> = V <sub>DS</sub> , I <sub>D</sub> = 1.0mA
I <sub>GSS</sub>	Gate-to-Source Leakage Forward	—	100	nA	V <sub>GS</sub> = 20V
I <sub>GSS</sub>	Gate-to-Source Leakage Reverse	—	-100		V <sub>GS</sub> = -20V
I <sub>DSS</sub>	Zero Gate Voltage Drain Current	—	10	μA	V <sub>DS</sub> =160V, V <sub>GS</sub> =0V
R <sub>DS(on)</sub>	Static Drain-to-Source ④ On-State Resistance (TO-3)	—	0.039	Ω	V <sub>GS</sub> = 12V, I <sub>D</sub> = 34A
R <sub>DS(on)</sub>	Static Drain-to-Source ④ On-State Resistance (SMD-2)	—	0.038	Ω	V <sub>GS</sub> = 12V, I <sub>D</sub> = 34A
V <sub>SD</sub>	Diode Forward Voltage ④	—	1.2	V	V <sub>GS</sub> = 0V, I <sub>D</sub> = 45A

International Rectifier radiation hardened MOSFETs have been characterized in heavy ion environment for Single Event Effects (SEE). Single Event Effects characterization is illustrated in Fig. a and Table 2.

**Table 2. Single Event Effect Safe Operating Area**

Ion	LET (MeV/(mg/cm <sup>2</sup> ))	Energy (MeV)	Range (μm)	V <sub>DS</sub> (V)				
				@ V <sub>GS</sub> =0V	@ V <sub>GS</sub> =-5V	@ V <sub>GS</sub> =-10V	@ V <sub>GS</sub> =-15V	@ V <sub>GS</sub> =-20V
Br	36.7	309	39.5	200	200	200	200	200
I	59.8	341	32.5	200	200	200	185	120
Au	82.3	350	28.4	200	200	150	50	25

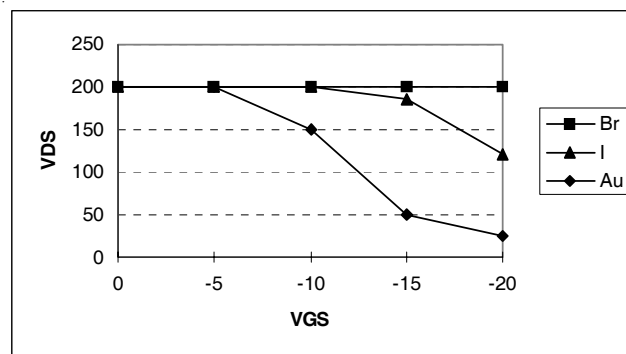

**Fig a. Single Event Effect, Safe Operating Area**

For footnotes refer to the last page

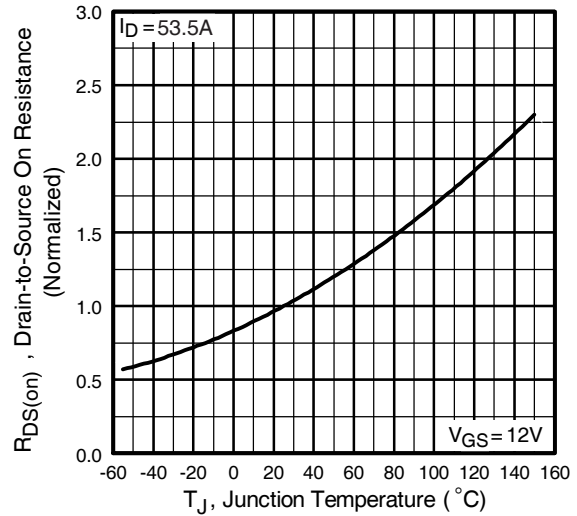
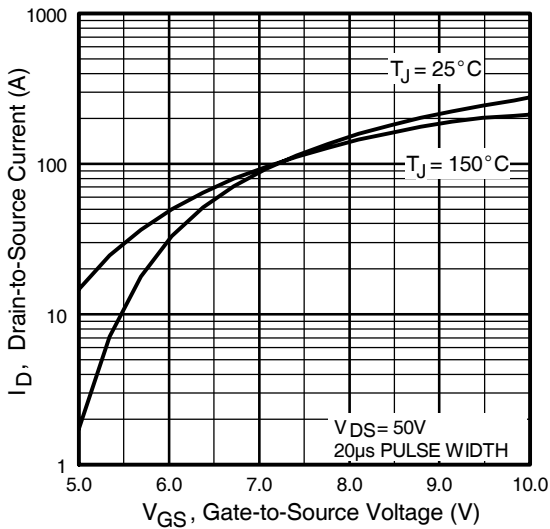
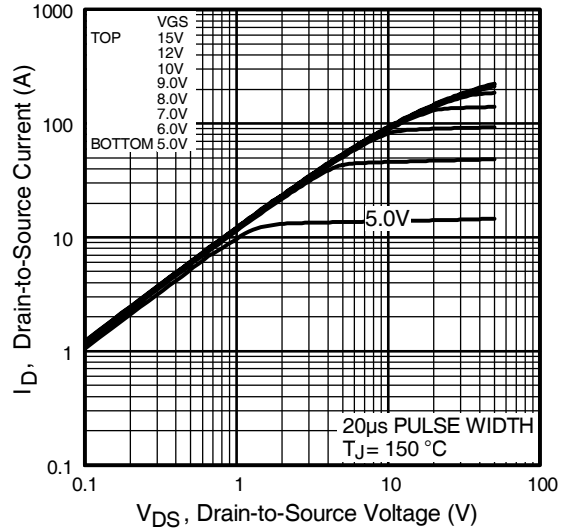
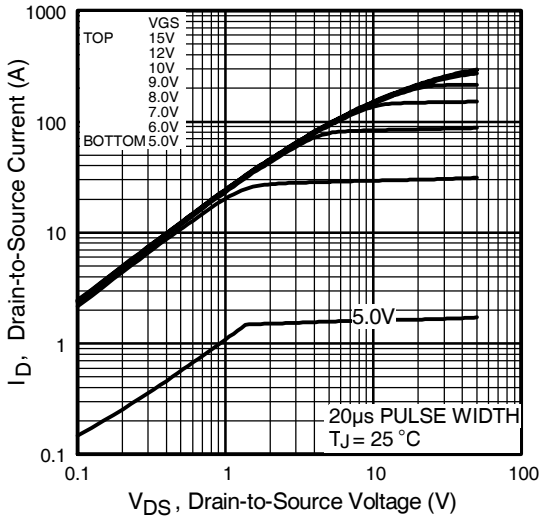

Fig 3. Typical Transfer Characteristics

Fig 4. Normalized On-Resistance Vs. Temperature

Pre-Irradiation

IRHNA57260SE, JANSR2N7473U2

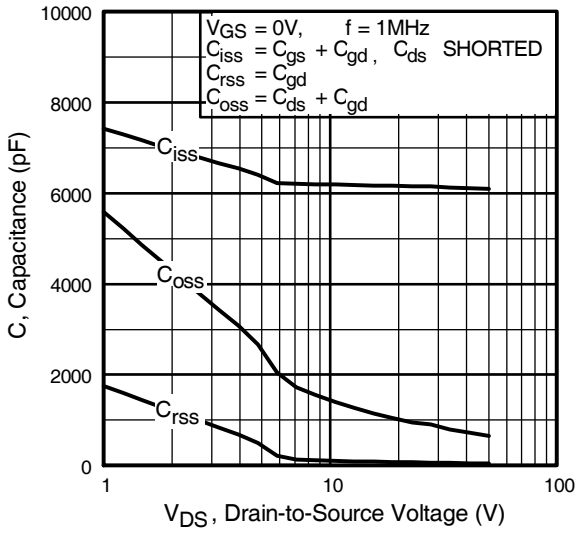

Fig 5. Typical Capacitance Vs. Drain-to-Source Voltage

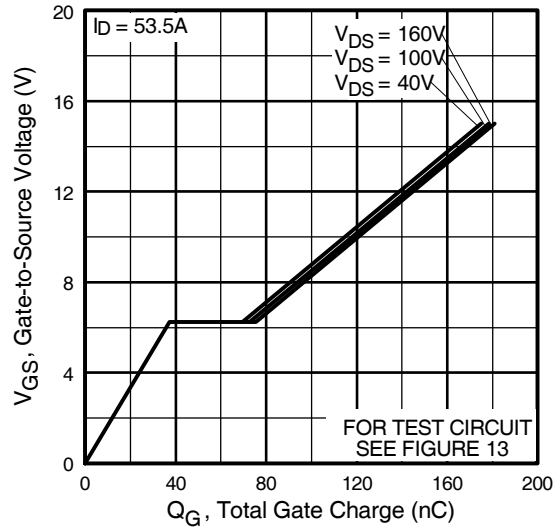

Fig 6. Typical Gate Charge Vs. Gate-to-Source Voltage

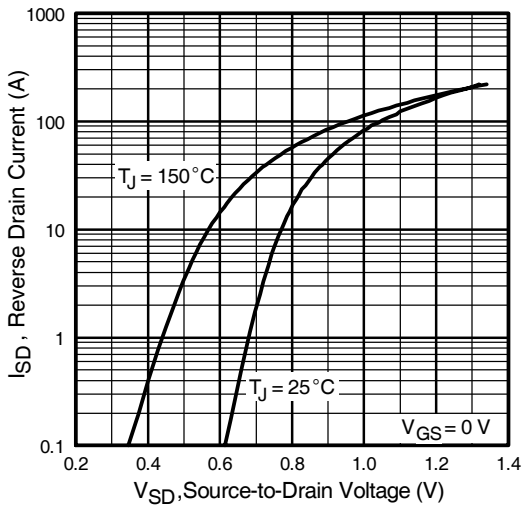

Fig 7. Typical Source-Drain Diode Forward Voltage

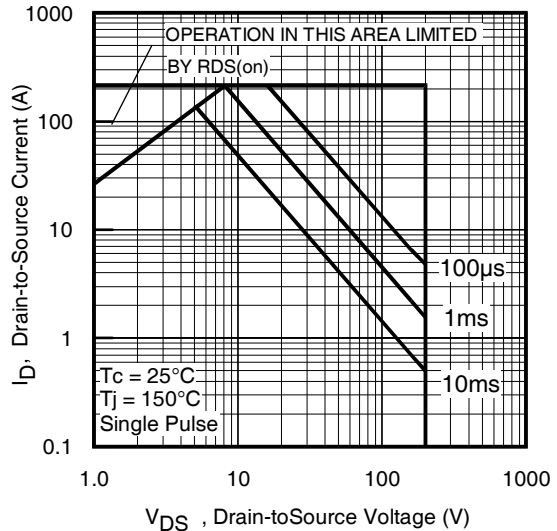

Fig 8. Maximum Safe Operating Area

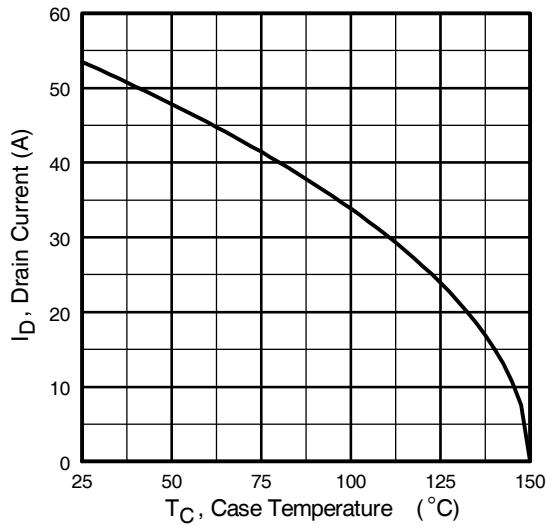

Fig 9. Maximum Drain Current Vs. Case Temperature

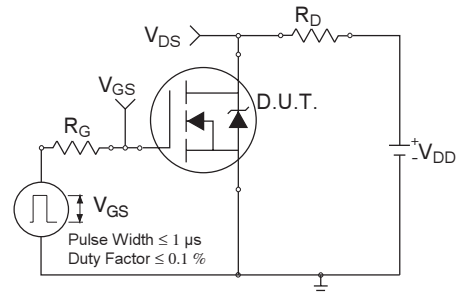

Fig 10a. Switching Time Test Circuit

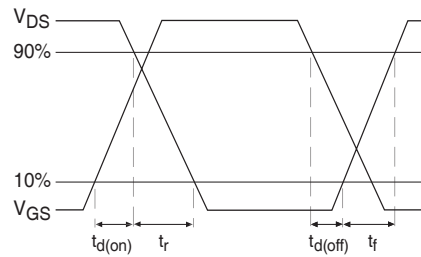

Fig 10b. Switching Time Waveforms

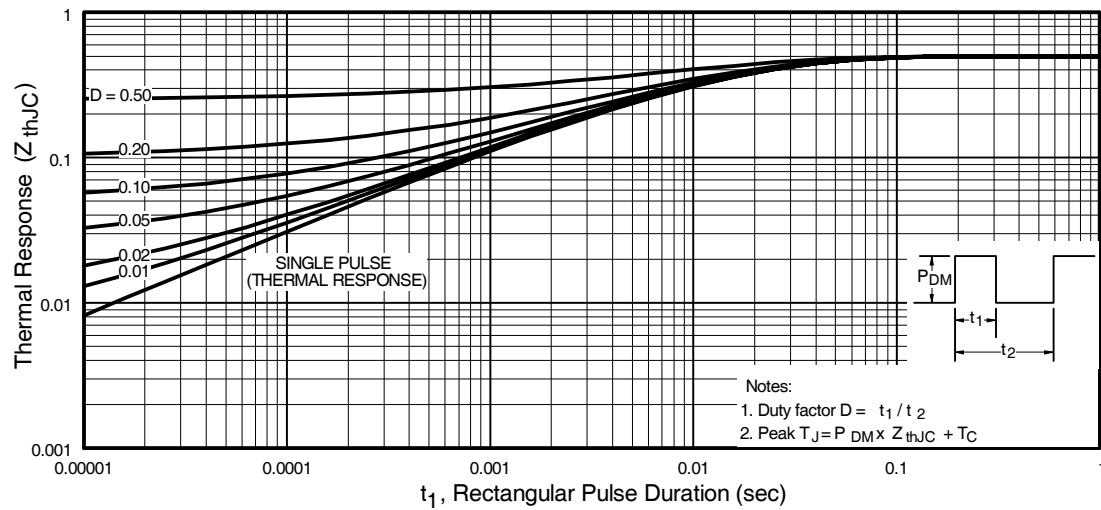

Fig 11. Maximum Effective Transient Thermal Impedance, Junction-to-Case

Pre-Irradiation

IRHNA57260SE, JANSR2N7473U2

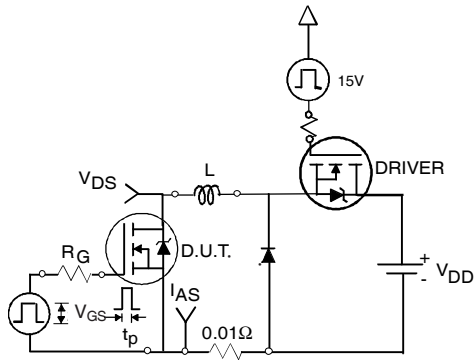

Fig 12a. Unclamped Inductive Test Circuit

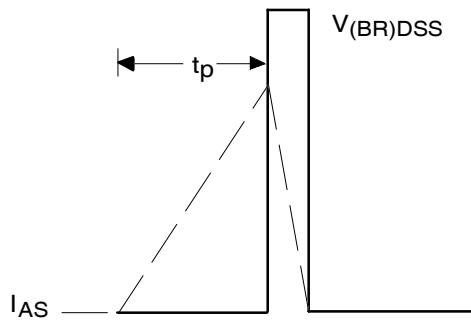

Fig 12b. Unclamped Inductive Waveforms

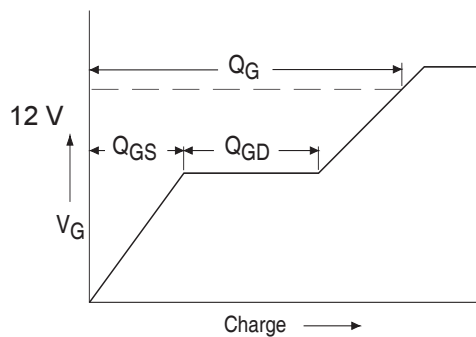

Fig 13a. Basic Gate Charge Waveform

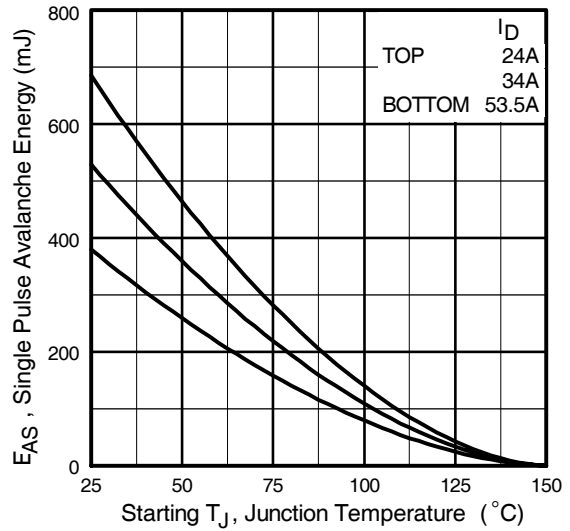

Fig 12c. Maximum Avalanche Energy Vs. Drain Current

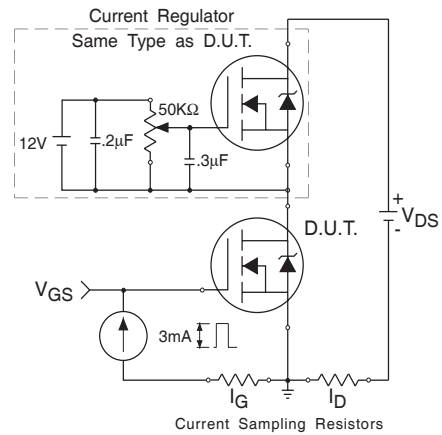
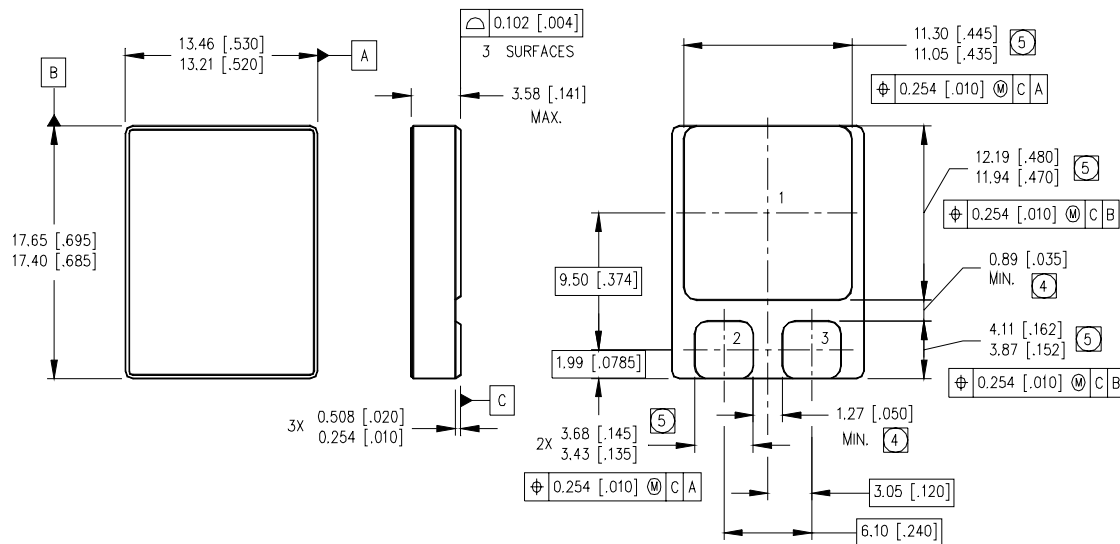

Fig 13b. Gate Charge Test Circuit

**Footnotes:**

- ① Repetitive Rating; Pulse width limited by maximum junction temperature.
- ②  $V_{DD} = 50V$ , starting  $T_J = 25^{\circ}C$ ,  $L = 0.27mH$   
Peak  $I_L = 53.5A$ ,  $V_{GS} = 12V$
- ③  $I_{SD} \leq 53.5A$ ,  $di/dt \leq 190A/\mu s$ ,  
 $V_{DD} \leq 200V$ ,  $T_J \leq 150^{\circ}C$
- ④ Pulse width  $\leq 300 \mu s$ ; Duty Cycle  $\leq 2\%$
- ⑤ **Total Dose Irradiation with  $V_{GS}$  Bias.**  
12 volt  $V_{GS}$  applied and  $V_{DS} = 0$  during irradiation per MIL-STD-750, method 1019, condition A.
- ⑥ **Total Dose Irradiation with  $V_{DS}$  Bias.**  
160 volt  $V_{DS}$  applied and  $V_{GS} = 0$  during irradiation per MIL-STD-750, method 1019, condition A.

**Case Outline and Dimensions — SMD-2**



NOTES:

- 1. DIMENSIONING & TOLERANCING PER ASME Y14.5M-1994.
- 2. CONTROLLING DIMENSION: INCH.
- 3. DIMENSIONS ARE SHOWN IN MILLIMETERS [INCHES].
- ④ DIMENSION INCLUDES METALLIZATION FLASH.
- ⑤ DIMENSION DOES NOT INCLUDE METALLIZATION FLASH.

PAD ASSIGNMENTS

- 1 = DRAIN
- 2 = GATE
- 3 = SOURCE

International  
**IOR** Rectifier

IR WORLD HEADQUARTERS: 233 Kansas St., El Segundo, California 90245, USA Tel: (310) 252-7105

IR LEOMINSTER : 205 Crawford St., Leominster, Massachusetts 01453, USA Tel: (978) 534-5776

TAC Fax: (310) 252-7903

Visit us at [www.irf.com](http://www.irf.com) for sales contact information.

Data and specifications subject to change without notice. 04/2006