

# The RF Line

## NPN Silicon

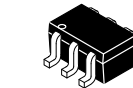
### Low Noise Transistors

## MRF2947AT1,T2 MRF2947RAT1,T2

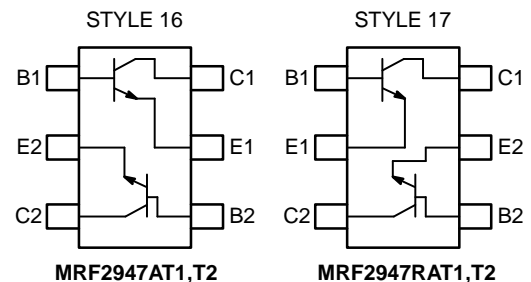
Motorola's MRF2947 device contains two high performance, low-noise NPN silicon bipolar transistors. This device has two 941 die housed in the high performance six leaded SC-70ML package; yielding a 9 GHz current gain-bandwidth product.

The RF performance at levels of 1 volt and 1 mA makes the MRF2947 well suited for low-voltage, low-current, front-end applications such as paging, cellular, GSM, DECT, CT2 and other portable wireless systems. The MRF2947 is fully ion-implanted with gold metallization and nitride passivation for maximum device reliability, performance and uniformity.

- Low Noise Figure, NF = 1.5 dB (Typ) @ 1 GHz @ 5 mA
- High Current Gain-Bandwidth Product,  $f_t = 9$  GHz (Typ) @ 6 Volts, 15 mA
- Maximum Stable Gain, 18 dB @ 1 GHz @ 5 mA
- Output Third Order Intercept, OIP<sub>3</sub> = +27 dBm
- Available in Tape and Reel Packaging Options:  
T1 Suffix = 3,000 Units per 8 mm, 7 inch Reel  
T2 Suffix = 3,000 Units per 8 mm, 7 inch Reel (reverse device orientation in tape)



CASE 419B-01, STYLES 16 & 17  
SC-70ML/SOT-363



#### MAXIMUM RATINGS

Rating	Symbol	Value	Unit
Collector-Emitter Voltage	$V_{CEO}$	10	Vdc
Collector-Base Voltage	$V_{CBO}$	20	Vdc
Emitter-Base Voltage	$V_{EBO}$	1.5	Vdc
Power Dissipation (1) $T_C = 75^\circ\text{C}$ Derate linearly above $T_C = 75^\circ\text{C}$ @	$P_{Dmax}$	0.188 2.5	Watts mW/ $^\circ\text{C}$
Collector Current — Continuous (2)	$I_C$	50	mA
Maximum Junction Temperature	$T_{Jmax}$	150	$^\circ\text{C}$
Storage Temperature	$T_{stg}$	-55 to +150	$^\circ\text{C}$
Thermal Resistance, Junction to Case	$R_{\theta JC}$	400	$^\circ\text{C}/\text{W}$

#### DEVICE MARKINGS

MRF2947AT1,T2 = WU  
MRF2947RAT1,T2 = XR

(1) To calculate the junction temperature use  $T_J = P_D \times R_{\theta JC} + T_C$ . The case temperature is measured on collector lead adjacent to the package body.

(2)  $I_C$  — Continuous (MTBF > 10 years).

**ELECTRICAL CHARACTERISTICS** ( $T_A = 25^\circ\text{C}$  unless otherwise noted)

Characteristic	Symbol	Min	Typ	Max	Unit
<b>OFF CHARACTERISTICS (3)</b>					
Collector–Emitter Breakdown Voltage ( $I_C = 0.1\text{ mA}$ , $I_B = 0$ )	$V_{(BR)CEO}$	10	12	—	Vdc
Collector–Base Breakdown Voltage ( $I_C = 0.1\text{ mA}$ , $I_E = 0$ )	$V_{(BR)CBO}$	20	23	—	Vdc
Emitter Cutoff Current ( $V_{EB} = 1\text{ V}$ , $I_C = 0$ )	$I_{EBO}$	—	—	0.1	$\mu\text{A}$
Collector Cutoff Current ( $V_{CB} = 10\text{ V}$ , $I_E = 0$ )	$I_{CBO}$	—	—	0.1	$\mu\text{A}$

**ON CHARACTERISTICS (3)**

DC Current Gain ( $V_{CE} = 1\text{ V}$ , $I_C = 500\text{ }\mu\text{A}$ )	$h_{FE1}$	50	—	—	—
DC Current Gain ( $V_{CE} = 6\text{ V}$ , $I_C = 5\text{ mA}$ )	$h_{FE3}$	75	—	150	—

**DYNAMIC CHARACTERISTICS**

Collector–Base Capacitance ( $V_{CB} = 1\text{ V}$ , $I_E = 0$ , $f = 1\text{ MHz}$ )	$C_{cb}$	—	0.42	—	pF
Current Gain — Bandwidth Product ( $V_{CE} = 6\text{ V}$ , $I_C = 15\text{ mA}$ , $f = 1\text{ GHz}$ )	$f_T$	—	9	—	GHz

**PERFORMANCE CHARACTERISTICS**

Conditions	Symbol	Min	Typ	Max	Unit
Insertion Gain ( $V_{CE} = 1\text{ V}$ , $I_C = 1\text{ mA}$ , $f = 1\text{ GHz}$ ) ( $V_{CE} = 6\text{ V}$ , $I_C = 15\text{ mA}$ , $f = 1\text{ GHz}$ )	$ S_{21} ^2$	— —	7 15	— —	dB
Maximum Unilateral Gain (4) ( $V_{CE} = 1\text{ V}$ , $I_C = 1\text{ mA}$ , $f = 1\text{ GHz}$ ) ( $V_{CE} = 6\text{ V}$ , $I_C = 15\text{ mA}$ , $f = 1\text{ GHz}$ )	$G_{Umax}$	— —	13 17	— —	dB
Maximum Stable Gain and/or Maximum Available Gain (5) ( $V_{CE} = 1\text{ V}$ , $I_C = 1\text{ mA}$ , $f = 1\text{ GHz}$ ) ( $V_{CE} = 6\text{ V}$ , $I_C = 15\text{ mA}$ , $f = 1\text{ GHz}$ )	MSG MAG	— —	12 18	— —	dB
Noise Figure — Minimum ( $V_{CE} = 1\text{ V}$ , $I_C = 1\text{ mA}$ , $f = 1\text{ GHz}$ ) ( $V_{CE} = 6\text{ V}$ , $I_C = 5\text{ mA}$ , $f = 1\text{ GHz}$ )	$NF_{min}$	— —	1.8 1.5	— —	dB
Noise Resistance ( $V_{CE} = 1\text{ V}$ , $I_C = 1\text{ mA}$ , $f = 1\text{ GHz}$ ) ( $V_{CE} = 6\text{ V}$ , $I_C = 5\text{ mA}$ , $f = 1\text{ GHz}$ )	$R_N$	— —	22 17	— —	$\Omega$
Associated Gain at Minimum NF ( $V_{CE} = 1\text{ V}$ , $I_C = 1\text{ mA}$ , $f = 1\text{ GHz}$ ) ( $V_{CE} = 6\text{ V}$ , $I_C = 5\text{ mA}$ , $f = 1\text{ GHz}$ )	$G_{NF}$	— —	9 14	— —	dB
Output Power at 1 dB Gain Compression (6) ( $V_{CE} = 6\text{ V}$ , $I_C = 15\text{ mA}$ , $f = 1\text{ GHz}$ )	$P_{1dB}$	—	+13	—	dBm
Output Third Order Intercept (6) ( $V_{CE} = 6\text{ V}$ , $I_C = 15\text{ mA}$ , $f = 1\text{ GHz}$ )	$OIP_3$	—	+27	—	dBm

(3) Pulse width  $\leq 300\text{ }\mu\text{s}$ , duty cycle  $\leq 2\%$  pulsed.

(4) Maximum unilateral gain is  $G_{Umax} = \frac{|S_{21}|^2}{(1-|S_{11}|^2)(1-|S_{22}|^2)}$

(5) Maximum available gain and maximum stable gain are defined by the K factor as follows:  $MAG = \frac{|S_{21}|}{|S_{12}|} (K \pm \sqrt{K^2 - 1})$ , if  $K > 1$

(6)  $Z_O = 50\text{ }\Omega$  and  $Z_{Out}$  matched for small signal maximum gain.

$$MSG = \frac{|S_{21}|}{|S_{12}|}, \text{ if } K < 1$$

## TYPICAL CHARACTERISTICS

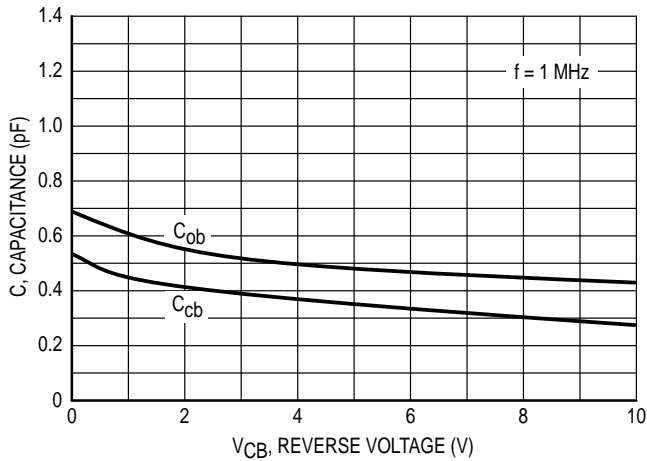


Figure 1. Capacitance versus Voltage

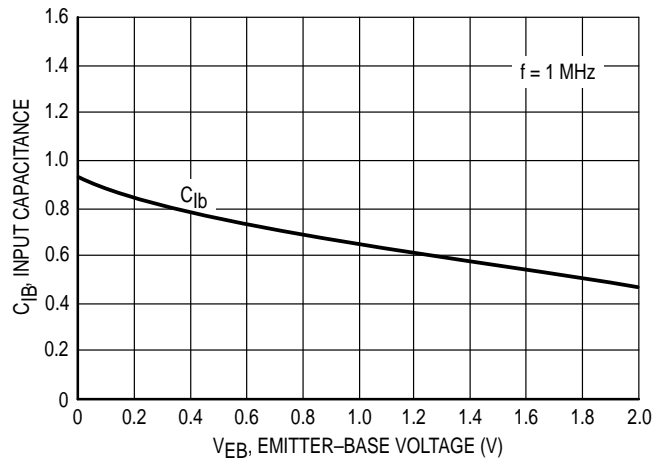


Figure 2. Input Capacitance versus Voltage

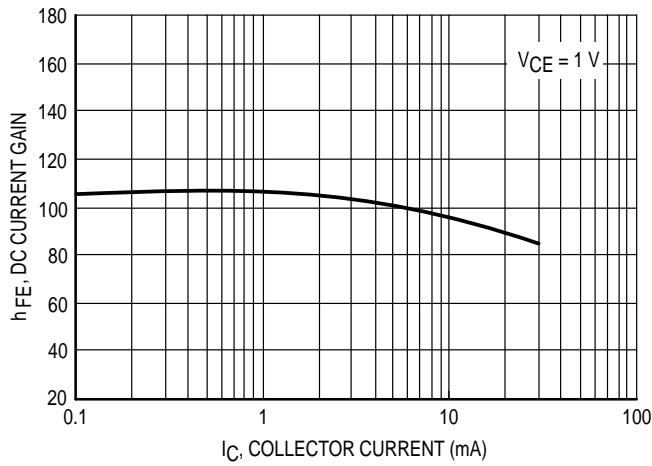


Figure 3. DC Current Gain versus Collector Current

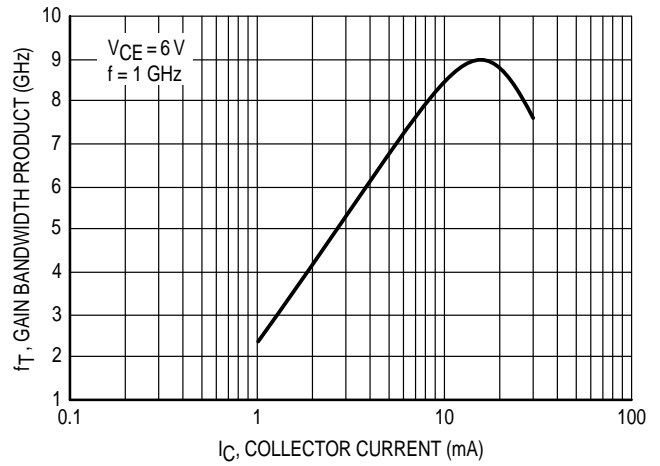


Figure 4. Gain-Bandwidth Product versus Collector Current

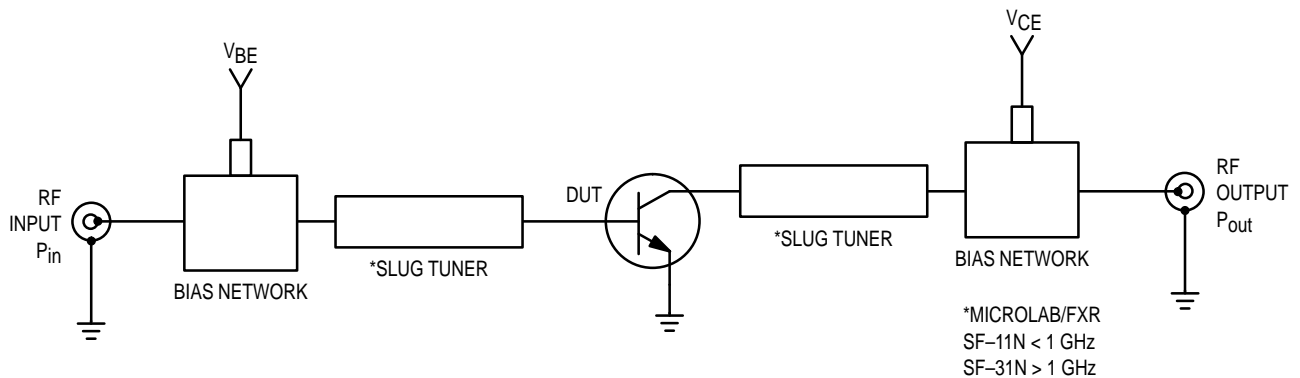
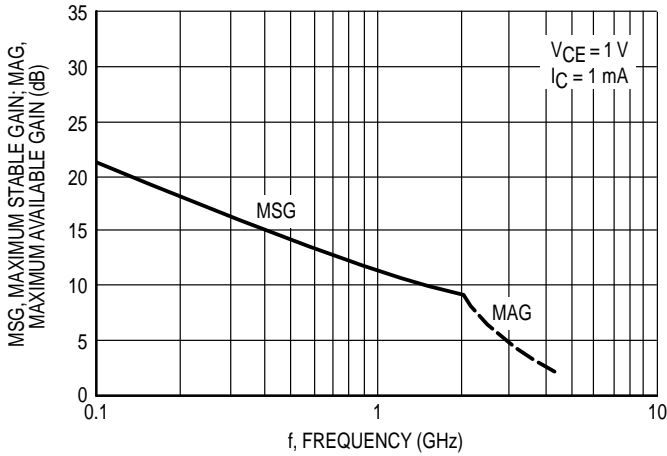
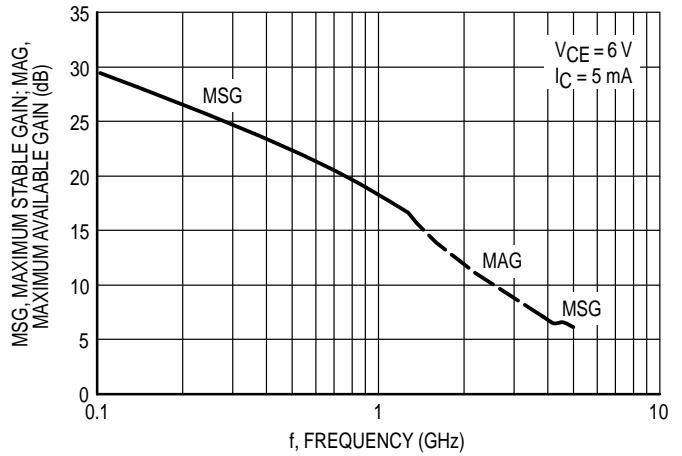


Figure 5. Functional Circuit Schematic

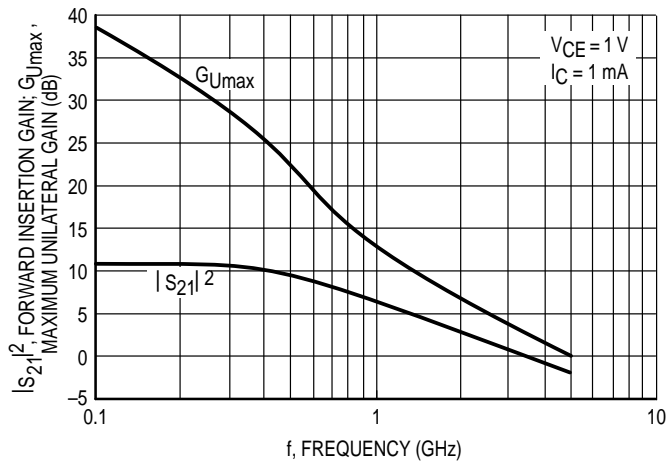
## TYPICAL CHARACTERISTICS



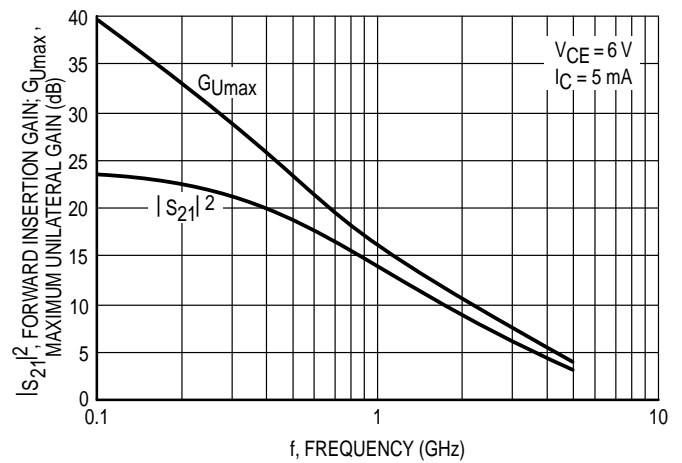
**Figure 6. Maximum Stable/Available Gain versus Frequency**



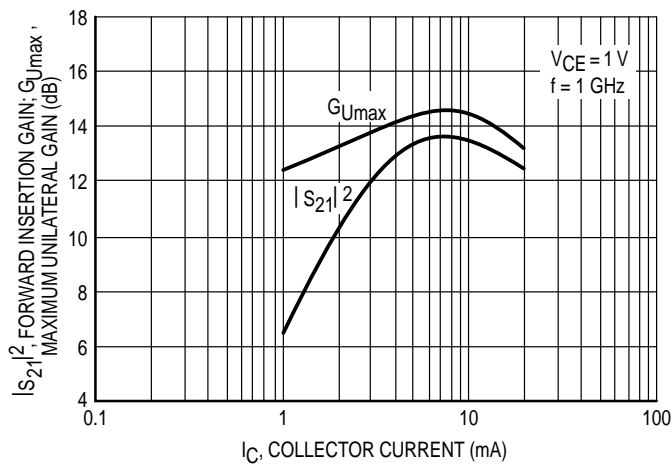
**Figure 7. Maximum Stable/Available Gain versus Frequency**



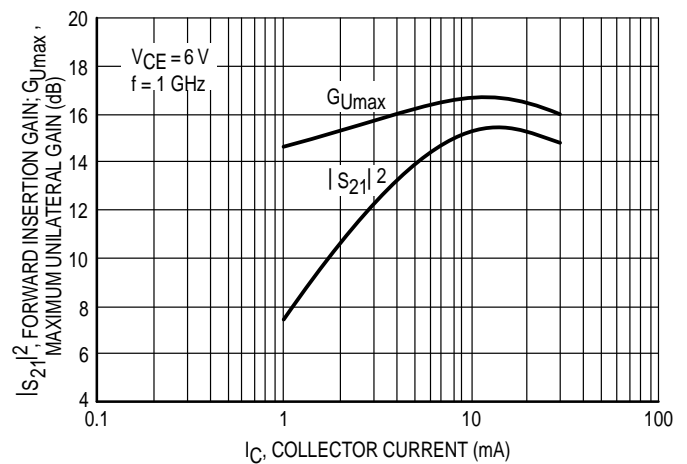
**Figure 8. Maximum Unilateral Gain and Forward Insertion Gain versus Frequency**



**Figure 9. Maximum Unilateral Gain and Forward Insertion Gain versus Frequency**

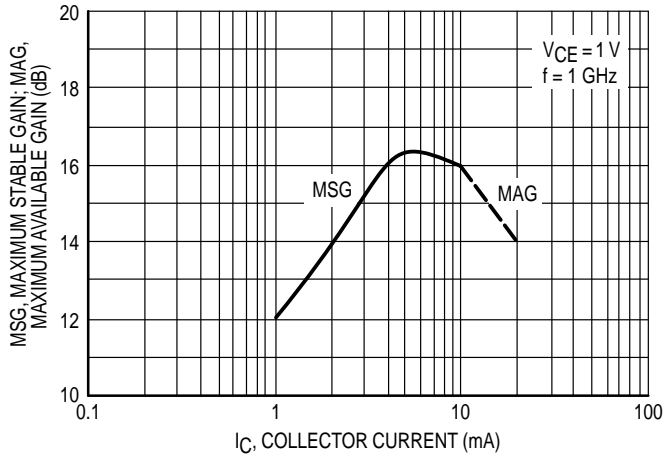


**Figure 10. Maximum Unilateral Gain and Forward Insertion Gain versus Collector Current**

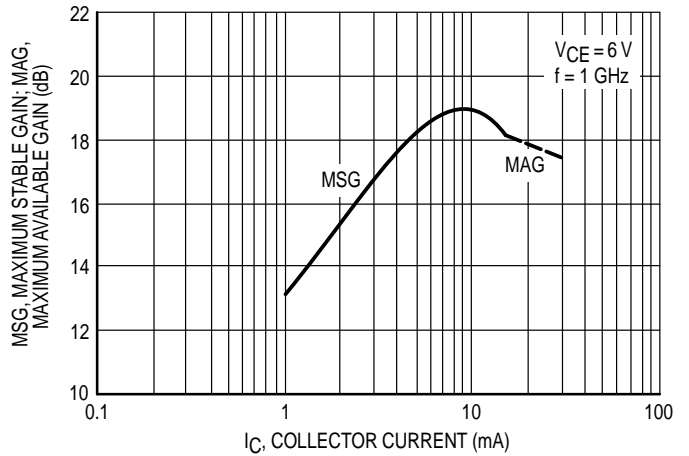


**Figure 11. Maximum Unilateral Gain and Forward Insertion Gain versus Collector Current**

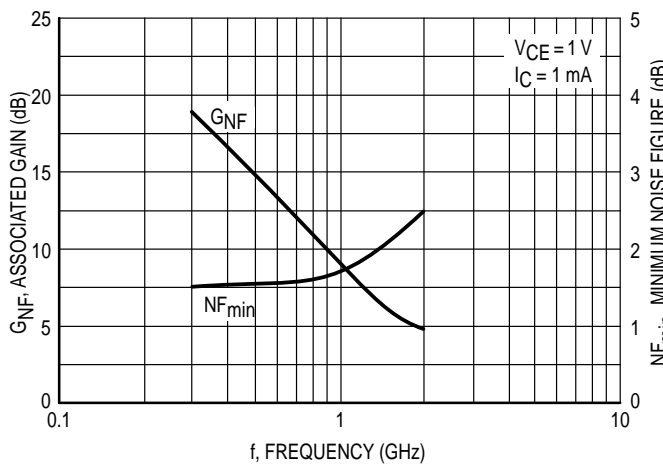
## TYPICAL CHARACTERISTICS



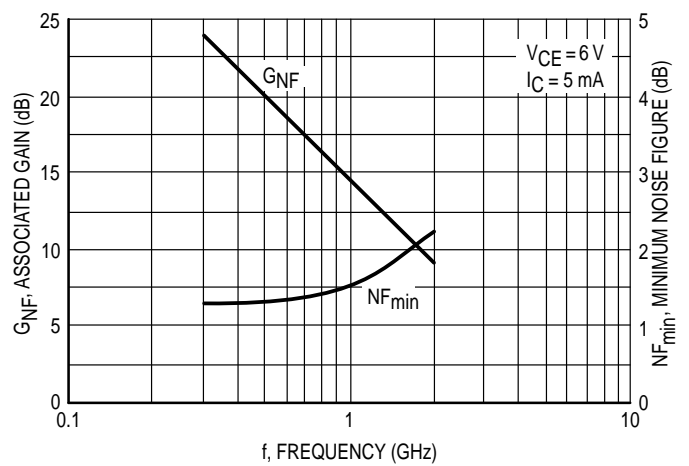
**Figure 12. Maximum Stable/Available Gain versus Collector Current**



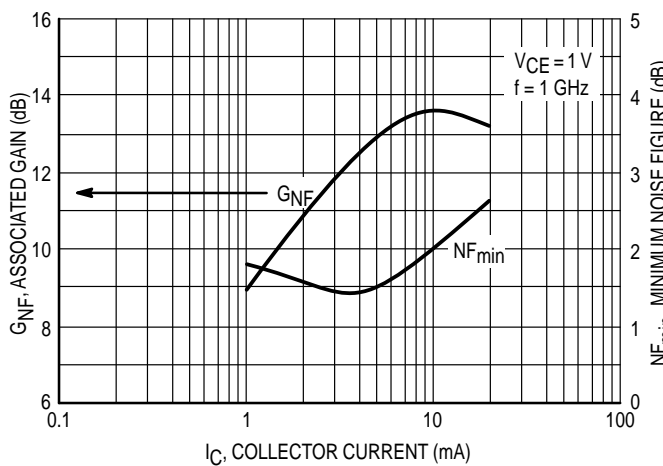
**Figure 13. Maximum Stable/Available Gain versus Collector Current**



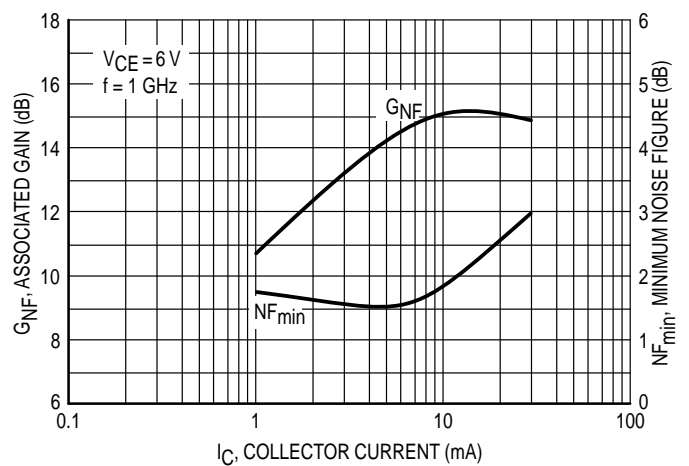
**Figure 14. Minimum Noise Figure and Associated Gain versus Frequency**



**Figure 15. Minimum Noise Figure and Associated Gain versus Frequency**

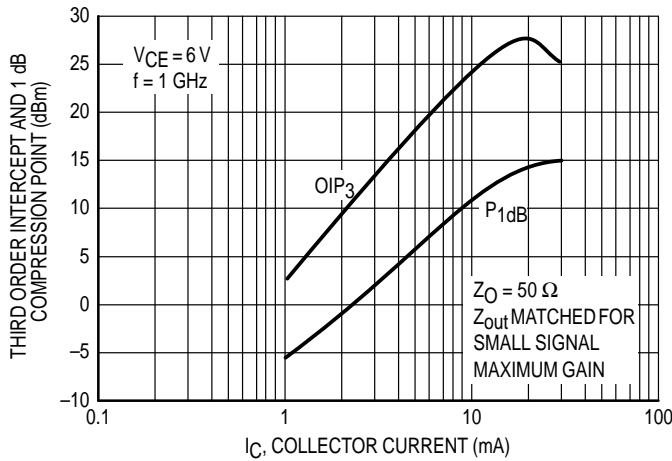


**Figure 16. Minimum Noise Figure and Associated Gain versus Collector Current**

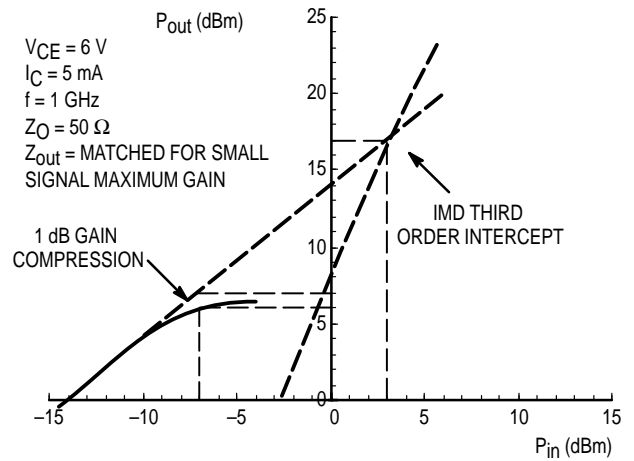


**Figure 17. Minimum Noise Figure and Associated Gain versus Collector Current**

## TYPICAL CHARACTERISTICS



**Figure 18. Output Third Order Intercept and Output Power at 1 dB Gain Compression versus Collector Current**



**Figure 19. 1 dB Gain Compression and Third Order Intercept**

VCE (Vdc)	IC (mA)	f (GHz)	S11		S21		S12		S22		
			S11	∠φ	S21	∠φ	S12	∠φ	S22	∠φ	
0.5	1.0	0.1	0.957	-15	3.60	168	0.035	81	0.985	-8	
		0.3	0.907	-42	3.33	147	0.098	64	0.932	-22	
		0.5	0.833	-65	2.87	127	0.139	50	0.845	-31	
		0.7	0.738	-85	2.50	112	0.165	39	0.770	-40	
		0.9	0.668	-102	2.20	99	0.181	31	0.707	-46	
		1.0	0.640	-110	2.07	94	0.186	28	0.680	-49	
		1.3	0.579	-132	1.75	78	0.194	20	0.617	-57	
		1.5	0.555	-144	1.58	70	0.197	16	0.593	-62	
		2.0	0.521	-171	1.27	50	0.191	10	0.555	-72	
		2.5	0.500	165	1.09	34	0.184	10	0.535	-83	
		3.0	0.504	145	0.95	21	0.185	14	0.526	-95	
		3.5	0.501	126	0.83	9	0.202	18	0.528	-107	
4.0	0.461	114	0.74	0	0.226	18	0.528	-121			
4.5	0.526	101	0.70	-8	0.262	20	0.521	-134			
5.0	0.559	85	0.64	-14	0.309	17	0.530	-148			
1.0	1.0	0.1	0.961	-13	3.60	170	0.028	82	0.989	-7	
		0.3	0.919	-37	3.38	150	0.078	67	0.950	-19	
		0.5	0.855	-58	2.96	132	0.114	54	0.878	-27	
		0.7	0.762	-77	2.62	117	0.138	44	0.814	-34	
		0.9	0.692	-93	2.35	105	0.154	36	0.757	-41	
		1.0	0.661	-101	2.22	99	0.159	33	0.731	-43	
		1.3	0.591	-122	1.90	83	0.168	26	0.671	-50	
		1.5	0.562	-133	1.72	75	0.171	22	0.645	-55	
		2.0	0.512	-160	1.40	56	0.169	17	0.603	-65	
		2.5	0.479	177	1.20	40	0.166	19	0.578	-75	
		3.0	0.474	156	1.06	27	0.172	23	0.561	-86	
		3.5	0.469	139	0.94	15	0.195	28	0.555	-99	
	4.0	0.455	124	0.84	5	0.230	29	0.545	-112		
	4.5	0.487	109	0.80	-3	0.281	29	0.526	-126		
	5.0	0.504	94	0.74	-11	0.341	25	0.519	-140		
	5.0	5.0	0.1	0.807	-28	14.46	158	0.026	75	0.930	-17
			0.3	0.638	-73	10.62	127	0.058	57	0.716	-38
			0.5	0.497	-99	7.61	109	0.074	50	0.558	-44
0.7			0.423	-120	5.85	96	0.087	48	0.470	-48	
0.9			0.379	-136	4.72	87	0.099	48	0.419	-51	
1.0			0.366	-143	4.30	83	0.105	48	0.398	-53	
1.3	0.342	-162	3.42	72	0.123	47	0.358	-56			

**Table 1. Common Emitter S-Parameters**

V <sub>CE</sub> (Vdc)	I <sub>C</sub> (mA)	f (GHz)	S <sub>11</sub>		S <sub>21</sub>		S <sub>12</sub>		S <sub>22</sub>				
			S <sub>11</sub>	∠φ	S <sub>21</sub>	∠φ	S <sub>12</sub>	∠φ	S <sub>22</sub>	∠φ			
		1.5	0.334	-171	3.01	66	0.135	47	0.343	-59			
		2.0	0.329	168	2.33	52	0.168	45	0.323	-67			
		2.5	0.323	150	1.93	39	0.203	42	0.310	-75			
		3.0	0.334	135	1.67	28	0.239	37	0.300	-85			
		3.5	0.339	122	1.48	17	0.277	32	0.294	-97			
		4.0	0.338	112	1.33	8	0.309	26	0.280	-110			
		4.5	0.374	101	1.24	-2	0.348	22	0.274	-122			
		5.0	0.392	89	1.16	-11	0.390	15	0.272	-135			
3.0	1.0	0.1	0.962	-12	3.64	171	0.020	83	0.992	-6			
		0.3	0.927	-34	3.44	153	0.058	69	0.966	-15			
		0.5	0.868	-54	3.05	135	0.085	57	0.910	-22			
		0.7	0.781	-72	2.74	121	0.105	47	0.863	-28			
		0.9	0.710	-88	2.49	109	0.118	40	0.818	-34			
		1.0	0.677	-96	2.37	104	0.123	37	0.795	-36			
		1.3	0.601	-117	2.04	88	0.130	29	0.747	-42			
		1.5	0.567	-129	1.85	80	0.134	26	0.723	-47			
		2.0	0.509	-158	1.49	60	0.131	21	0.691	-56			
		2.5	0.470	177	1.27	44	0.129	24	0.673	-65			
		3.0	0.463	154	1.11	31	0.135	30	0.665	-74			
		3.5	0.458	134	0.96	18	0.155	35	0.667	-85			
	4.0	0.441	119	0.85	9	0.183	37	0.663	-97				
	4.5	0.483	104	0.81	0	0.225	37	0.653	-108				
	5.0	0.512	87	0.73	-8	0.274	34	0.657	-120				
	3.0	3.0	0.1	0.890	-18	9.77	165	0.020	80	0.973	-10		
			0.3	0.784	-51	8.36	140	0.050	63	0.874	-24		
			0.5	0.651	-74	6.66	121	0.069	52	0.756	-31		
			0.7	0.548	-95	5.43	107	0.080	47	0.678	-36		
			0.9	0.473	-111	4.54	97	0.088	44	0.625	-39		
			1.0	0.446	-119	4.19	92	0.092	43	0.600	-41		
			1.3	0.389	-139	3.39	79	0.103	42	0.556	-45		
			1.5	0.366	-151	3.00	73	0.110	41	0.538	-48		
			2.0	0.340	-177	2.34	57	0.128	41	0.516	-56		
			2.5	0.323	160	1.94	43	0.150	41	0.505	-64		
			3.0	0.331	141	1.66	31	0.175	40	0.500	-72		
			3.5	0.335	124	1.45	20	0.204	37	0.502	-83		
			4.0	0.333	112	1.29	10	0.229	33	0.495	-93		
			4.5	0.377	99	1.20	0	0.263	31	0.492	-103		
			5.0	0.408	84	1.10	-9	0.300	26	0.499	-114		
			5.0	5.0	0.1	0.823	-24	14.80	161	0.018	77	0.952	-13
					0.3	0.666	-63	11.47	131	0.045	60	0.790	-29
					0.5	0.514	-87	8.47	113	0.058	53	0.653	-34
	0.7	0.425			-108	6.60	100	0.069	51	0.577	-38		
	0.9	0.366			-124	5.37	91	0.078	50	0.532	-40		
	1.0	0.347			-132	4.91	86	0.083	50	0.512	-42		
1.3	0.309	-152			3.91	75	0.098	50	0.479	-44			
1.5	0.295	-163			3.44	70	0.108	49	0.465	-48			
2.0	0.284	172			2.65	55	0.134	48	0.449	-55			
2.5	0.277	151			2.18	43	0.161	45	0.442	-63			
3.0	0.291	134			1.87	31	0.190	42	0.440	-71			
3.5	0.298	118			1.63	20	0.221	37	0.441	-82			
4.0	0.299	108			1.46	11	0.245	32	0.431	-92			
4.5	0.343	96			1.35	1	0.278	29	0.430	-102			
5.0	0.373	82			1.24	-8	0.313	23	0.436	-113			

Table 1. Common Emitter S-Parameters (continued)

V <sub>CE</sub> (Vdc)	I <sub>C</sub> (mA)	f (GHz)	S <sub>11</sub>		S <sub>21</sub>		S <sub>12</sub>		S <sub>22</sub>	
			S <sub>11</sub>	∠φ	S <sub>21</sub>	∠φ	S <sub>12</sub>	∠φ	S <sub>22</sub>	∠φ
6.0	1.0	0.1	0.968	-11	3.66	171	0.017	83	0.993	-5
		0.3	0.933	-32	3.48	154	0.049	71	0.970	-14
		0.5	0.878	-50	3.10	137	0.073	59	0.924	-20
		0.7	0.789	-67	2.81	123	0.091	50	0.881	-26
		0.9	0.716	-82	2.56	112	0.103	43	0.839	-31
		1.0	0.683	-89	2.44	106	0.107	40	0.820	-33
		1.3	0.600	-109	2.11	91	0.115	34	0.775	-39
		1.5	0.564	-120	1.92	83	0.118	31	0.753	-43
		2.0	0.492	-148	1.57	64	0.118	28	0.721	-52
		2.5	0.444	-172	1.34	48	0.119	32	0.701	-60
		3.0	0.428	165	1.17	34	0.129	39	0.691	-70
		3.5	0.417	146	1.03	22	0.155	44	0.688	-81
		4.0	0.402	130	0.92	12	0.190	46	0.682	-92
		4.5	0.432	114	0.88	3	0.240	45	0.668	-103
		5.0	0.451	97	0.80	-5	0.302	41	0.662	-115
	5.0	0.1	0.850	-21	14.49	162	0.016	78	0.959	-11
		0.3	0.691	-57	11.47	133	0.039	63	0.820	-25
		0.5	0.533	-79	8.58	115	0.052	56	0.699	-29
		0.7	0.430	-97	6.74	102	0.062	54	0.629	-32
		0.9	0.362	-111	5.50	92	0.072	53	0.588	-35
		1.0	0.337	-118	5.04	88	0.076	53	0.570	-36
		1.3	0.286	-137	4.02	77	0.090	53	0.540	-39
		1.5	0.268	-147	3.54	71	0.100	53	0.528	-42
		2.0	0.242	-173	2.75	57	0.125	52	0.512	-49
		2.5	0.226	167	2.27	45	0.152	50	0.504	-56
		3.0	0.232	149	1.95	33	0.182	47	0.499	-64
		3.5	0.236	133	1.71	23	0.214	43	0.497	-74
		4.0	0.240	123	1.54	13	0.242	39	0.486	-84
		4.5	0.276	110	1.43	4	0.280	35	0.482	-93
		5.0	0.296	97	1.33	-6	0.321	30	0.481	-104
	15.0	0.1	0.656	-37	28.03	149	0.014	74	0.879	-17
		0.3	0.423	-83	16.63	115	0.030	63	0.639	-29
		0.5	0.293	-105	10.92	100	0.041	64	0.547	-28
		0.7	0.240	-123	8.09	91	0.052	65	0.509	-28
		0.9	0.209	-138	6.41	83	0.065	65	0.490	-30
		1.0	0.201	-145	5.82	80	0.071	65	0.481	-31
		1.3	0.186	-162	4.56	71	0.089	63	0.469	-34
		1.5	0.183	-171	3.99	66	0.102	62	0.462	-37
		2.0	0.184	168	3.06	54	0.133	58	0.456	-45
		2.5	0.182	150	2.51	43	0.164	54	0.454	-53
		3.0	0.197	136	2.15	32	0.196	49	0.451	-61
		3.5	0.206	124	1.88	22	0.230	44	0.449	-71
		4.0	0.215	115	1.69	13	0.258	38	0.436	-80
		4.5	0.252	105	1.57	4	0.294	34	0.433	-90
		5.0	0.272	92	1.46	-6	0.334	28	0.432	-100

Table 1. Common Emitter S-Parameters (continued)

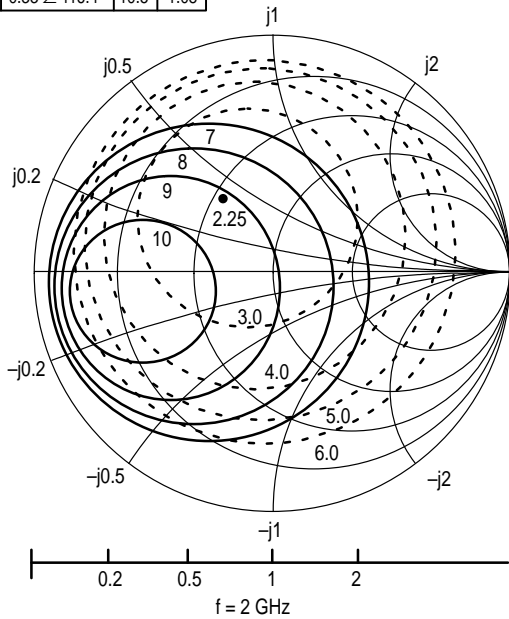


V <sub>CE</sub> (V <sub>dc</sub> )	I <sub>C</sub> (mA)	f (GHz)	NF <sub>min</sub> (dB)	Γ <sub>o</sub>		R <sub>N</sub> (Ω)	R <sub>N</sub>	GNF (dB)
				MAG	∠φ			
1.0	1.0	0.3	1.50	0.67	18	27	0.54	18.1
		0.5	1.53	0.62	31	26	0.52	14.6
		0.7	1.56	0.59	44	25	0.49	11.9
		0.9	1.70	0.56	57	23	0.45	9.7
		1.0	1.81	0.53	64	22	0.44	8.8
		1.5	2.19	0.50	97	16	0.31	5.7
		2.0	2.57	0.48	131	9	0.19	4.8
3.0	3.0	0.3	1.19	0.53	15	19	0.37	21.9
		0.5	1.19	0.49	26	18	0.36	18.3
		0.7	1.22	0.45	37	17	0.34	15.6
		0.9	1.36	0.42	49	16	0.32	13.8
		1.0	1.46	0.41	56	16	0.31	12.7
		1.5	1.82	0.37	89	13	0.25	9.6
		2.0	2.13	0.35	127	9	0.18	7.9
6.0	5.0	0.3	1.28	0.49	16	19	0.38	24.8
		0.5	1.28	0.46	24	18	0.37	20.4
		0.7	1.33	0.43	34	18	0.35	17.7
		0.9	1.45	0.41	44	17	0.34	15.6
		1.0	1.55	0.40	50	17	0.34	14.3
		1.5	1.95	0.36	81	14	0.28	11.3
		2.0	2.25	0.33	116	11	0.21	9.2

Table 2. Common Emitter Noise Parameters

$V_{CE} = 6\text{ V}$   
 $I_C = 5\text{ mA}$

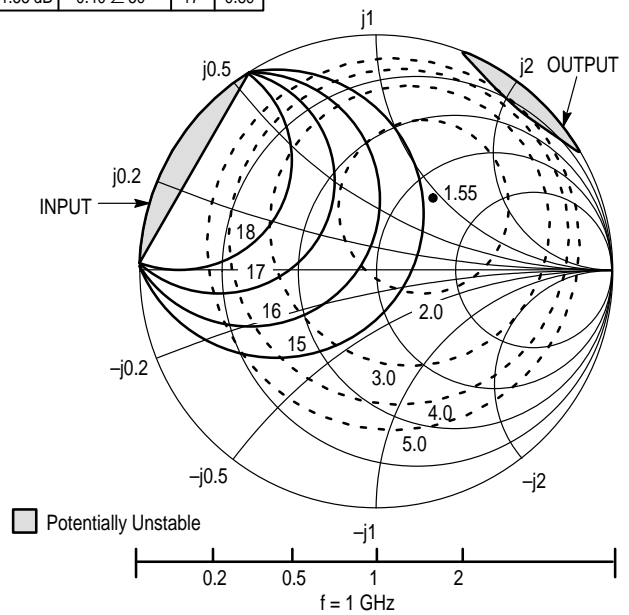
f (GHz)	NF OPT	$\Gamma_O$	$R_N$	K
2.0	2.25 dB	$0.33 \angle 116.4^\circ$	10.5	1.08



**Figure 20. MRF2947 Series Constant Gain and Noise Figure Contours**

$V_{CE} = 6\text{ V}$   
 $I_C = 5\text{ mA}$

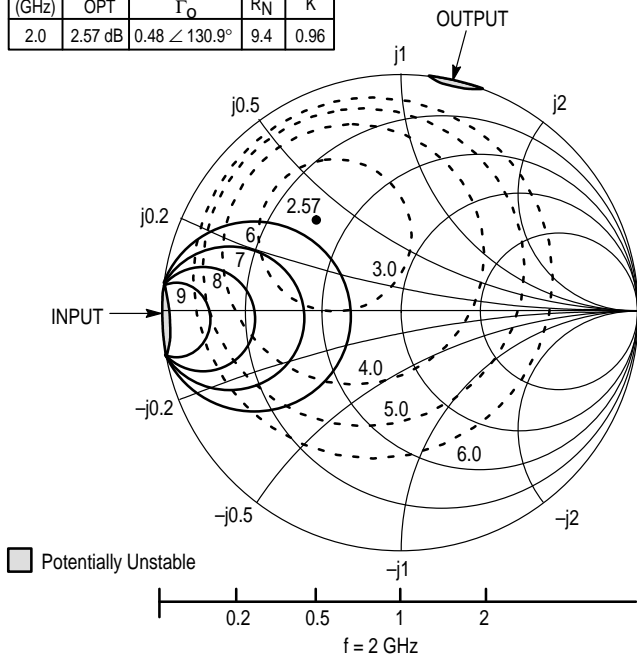
f (GHz)	NF OPT	$\Gamma_O$	$R_N$	K
1.0	1.55 dB	$0.40 \angle 50^\circ$	17	0.89



**Figure 21. MRF2947 Series Constant Gain and Noise Figure Contours**

$V_{CE} = 1\text{ V}$   
 $I_C = 1\text{ mA}$

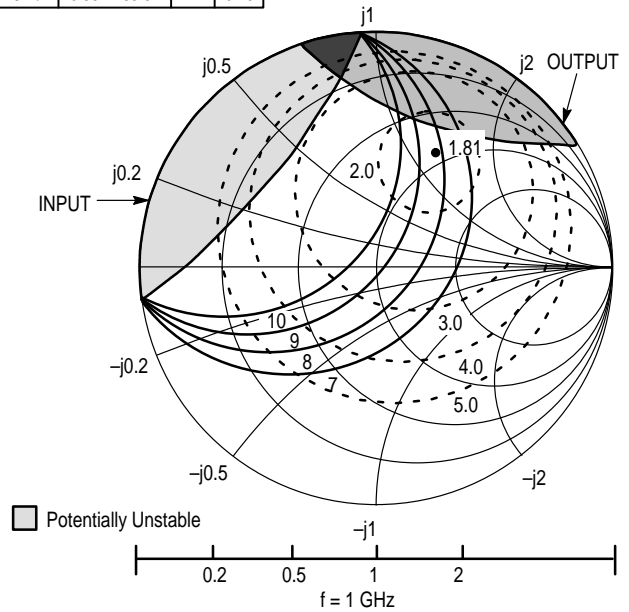
f (GHz)	NF OPT	$\Gamma_O$	$R_N$	K
2.0	2.57 dB	$0.48 \angle 130.9^\circ$	9.4	0.96



**Figure 22. MRF2947 Series Constant Gain and Noise Figure Contours**

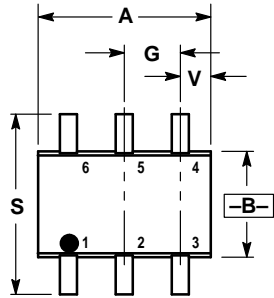
$V_{CE} = 1\text{ V}$   
 $I_C = 1\text{ mA}$

f (GHz)	NF OPT	$\Gamma_O$	$R_N$	K
1.0	1.81 dB	$0.53 \angle 63.5^\circ$	22	0.49

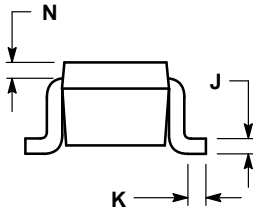
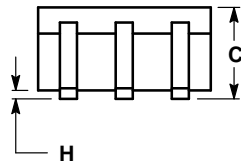


**Figure 23. MRF2947 Series Constant Gain and Noise Figure Contours**

# PACKAGE DIMENSIONS



D 6 PL  $\oplus$  0.2 (0.008) (M) B (M)




- NOTES:  
 1. DIMENSIONING AND TOLERANCING PER ANSI Y14.5M, 1982.  
 2. CONTROLLING DIMENSION: INCH.

DIM	INCHES		MILLIMETERS	
	MIN	MAX	MIN	MAX
A	0.071	0.087	1.80	2.20
B	0.045	0.053	1.15	1.35
C	0.031	0.043	0.80	1.10
D	0.004	0.012	0.10	0.30
G	0.026 BSC		0.65 BSC	
H	—	0.004	—	0.10
J	0.004	0.010	0.10	0.25
K	0.004	0.012	0.10	0.30
N	0.008 REF		0.20 REF	
S	0.079	0.087	2.00	2.20
V	0.012	0.016	0.30	0.40

- STYLE 16:  
 PIN 1. BASE 1  
 2. EMITTER 2  
 3. COLLECTOR 2  
 4. BASE 2  
 5. EMITTER 1  
 6. COLLECTOR 1
- STYLE 17:  
 PIN 1. BASE 1  
 2. EMITTER 1  
 3. COLLECTOR 2  
 4. BASE 2  
 5. EMITTER 2  
 6. COLLECTOR 1

**CASE 419B-01  
 ISSUE G**

Motorola reserves the right to make changes without further notice to any products herein. Motorola makes no warranty, representation or guarantee regarding the suitability of its products for any particular purpose, nor does Motorola assume any liability arising out of the application or use of any product or circuit, and specifically disclaims any and all liability, including without limitation consequential or incidental damages. "Typical" parameters which may be provided in Motorola data sheets and/or specifications can and do vary in different applications and actual performance may vary over time. All operating parameters, including "Typicals" must be validated for each customer application by customer's technical experts. Motorola does not convey any license under its patent rights nor the rights of others. Motorola products are not designed, intended, or authorized for use as components in systems intended for surgical implant into the body, or other applications intended to support or sustain life, or for any other application in which the failure of the Motorola product could create a situation where personal injury or death may occur. Should Buyer purchase or use Motorola products for any such unintended or unauthorized application, Buyer shall indemnify and hold Motorola and its officers, employees, subsidiaries, affiliates, and distributors harmless against all claims, costs, damages, and expenses, and reasonable attorney fees arising out of, directly or indirectly, any claim of personal injury or death associated with such unintended or unauthorized use, even if such claim alleges that Motorola was negligent regarding the design or manufacture of the part. Motorola and  are registered trademarks of Motorola, Inc. Motorola, Inc. is an Equal Opportunity/Affirmative Action Employer.

Mfax is a trademark of Motorola, Inc.

**How to reach us:**

**USA/EUROPE/Locations Not Listed:** Motorola Literature Distribution;  
P.O. Box 5405, Denver, Colorado 80217. 1-303-675-2140 or 1-800-441-2447

**JAPAN:** Nippon Motorola Ltd.: SPD, Strategic Planning Office, 4-32-1,  
Nishi-Gotanda, Shinagawa-ku, Tokyo 141, Japan. 81-3-5487-8488

**Customer Focus Center: 1-800-521-6274**

**Mfax™:** RMFAX0@email.sps.mot.com – TOUCHTONE 1-602-244-6609  
Motorola Fax Back System – US & Canada ONLY 1-800-774-1848  
– http://sps.motorola.com/mfax/

**ASIA/PACIFIC:** Motorola Semiconductors H.K. Ltd.; 8B Tai Ping Industrial Park,  
51 Ting Kok Road, Tai Po, N.T., Hong Kong. 852-26629298

**HOME PAGE:** <http://motorola.com/sps/>



**MRF2947/D**