



RF Power Field Effect Transistors

N-Channel Enhancement-Mode Lateral MOSFETs

Designed for Class AB PCN and PCS base station applications with frequencies from 1900 to 2000 MHz. Suitable for CDMA, TDMA, GSM, and multicarrier amplifier applications.

- Typical CDMA Performance: 1990 MHz, 26 Volts
 IS-95 CDMA Pilot, Sync, Paging, Traffic Codes 8 Through 13
 Output Power — 9 Watts Avg.
 Power Gain — 10 dB
 Adjacent Channel Power —
 885 kHz: -47 dBc @ 30 kHz BW
 1.25 MHz: -55 dBc @ 12.5 kHz BW
 2.25 MHz: -55 dBc @ 1 MHz BW
- Capable of Handling 10:1 VSWR, @ 26 Vdc, 1960 MHz, 90 Watts CW Output Power

Features

- Internally Matched for Ease of Use
- High Gain, High Efficiency and High Linearity
- Integrated ESD Protection
- Designed for Maximum Gain and Insertion Phase Flatness
- Excellent Thermal Stability
- Characterized with Series Equivalent Large-Signal Impedance Parameters
- RoHS Compliant
- In Tape and Reel. R3 Suffix = 250 Units per 56 mm, 13 inch Reel.

MRF19090R3
MRF19090SR3

1930-1990 MHz, 90 W, 26 V
LATERAL N-CHANNEL
RF POWER MOSFETs

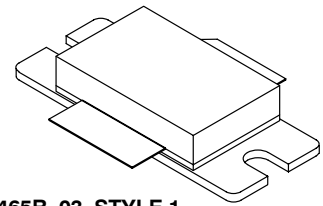

CASE 465B-03, STYLE 1
NI-880
MRF19090R3

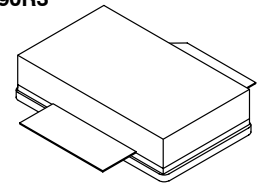

CASE 465C-02, STYLE 1
NI-880S
MRF19090SR3

Table 1. Maximum Ratings

Rating	Symbol	Value	Unit
Drain-Source Voltage	V_{DSS}	-0.5, +65	Vdc
Gate-Source Voltage	V_{GS}	-0.5, +15	Vdc
Total Device Dissipation @ $T_C = 25^\circ\text{C}$ Derate above 25°C	P_D	270 1.54	W W/ $^\circ\text{C}$
Storage Temperature Range	T_{stg}	- 65 to +150	$^\circ\text{C}$
Case Operating Temperature	T_C	150	$^\circ\text{C}$
Operating Junction Temperature	T_J	200	$^\circ\text{C}$

Table 2. Thermal Characteristics

Characteristic	Symbol	Value	Unit
Thermal Resistance, Junction to Case	$R_{\theta JC}$	0.65	$^\circ\text{C}/\text{W}$

Table 3. ESD Protection Characteristics

Test Conditions	Class
Human Body Model	1 (Minimum)
Machine Model	M3 (Minimum)

Table 4. Electrical Characteristics ($T_C = 25^\circ\text{C}$ unless otherwise noted)

Characteristic	Symbol	Min	Typ	Max	Unit
Off Characteristics					
Drain-Source Breakdown Voltage ($V_{GS} = 0\text{ Vdc}$, $I_D = 100\ \mu\text{A}$)	$V_{(BR)DSS}$	65	—	—	Vdc
Zero Gate Voltage Drain Current ($V_{DS} = 28\text{ Vdc}$, $V_{GS} = 0\text{ Vdc}$)	I_{DSS}	—	—	10	μAdc
Gate-Source Leakage Current ($V_{GS} = 5\text{ Vdc}$, $V_{DS} = 0\text{ Vdc}$)	I_{GSS}	—	—	1	μAdc
On Characteristics					
Forward Transconductance ($V_{DS} = 10\text{ Vdc}$, $I_D = 3\text{ Adc}$)	g_{fs}	—	7.2	—	S
Gate Threshold Voltage ($V_{DS} = 10\text{ Vdc}$, $I_D = 300\ \mu\text{Adc}$)	$V_{GS(th)}$	2.0	—	4.0	Vdc
Gate Quiescent Voltage ($V_{DS} = 26\text{ Vdc}$, $I_D = 750\text{ mAdc}$)	$V_{GS(Q)}$	2.5	3.8	4.5	Vdc
Drain-Source On-Voltage ($V_{GS} = 10\text{ Vdc}$, $I_D = 1\text{ Adc}$)	$V_{DS(on)}$	—	0.10	—	Vdc
Dynamic Characteristics					
Reverse Transfer Capacitance (1) ($V_{DS} = 26\text{ Vdc}$, $V_{GS} = 0$, $f = 1\text{ MHz}$)	C_{rss}	—	4.2	—	pF
Functional Tests (In Freescale Test Fixture)					
Two-Tone Common-Source Amplifier Power Gain ($V_{DD} = 26\text{ Vdc}$, $P_{out} = 90\text{ W PEP}$, $I_{DQ} = 750\text{ mA}$, $f = 1930\text{ MHz}$ and 1990 MHz , Tone Spacing = 100 kHz)	G_{ps}	10	11.5	—	dB
Two-Tone Drain Efficiency ($V_{DD} = 26\text{ Vdc}$, $P_{out} = 90\text{ W PEP}$, $I_{DQ} = 750\text{ mA}$, $f = 1930\text{ MHz}$ and 1990 MHz , Tone Spacing = 100 kHz)	η	33	35	—	%
3rd Order Intermodulation Distortion ($V_{DD} = 26\text{ Vdc}$, $P_{out} = 90\text{ W PEP}$, $I_{DQ} = 750\text{ mA}$, $f = 1930\text{ MHz}$ and 1990 MHz , Tone Spacing = 100 kHz)	IMD	—	-30	-28	dBc
Input Return Loss ($V_{DD} = 26\text{ Vdc}$, $P_{out} = 90\text{ W PEP}$, $I_{DQ} = 750\text{ mA}$, $f = 1930\text{ MHz}$ and 1990 MHz , Tone Spacing = 100 kHz)	IRL	—	-12	—	dB
P_{out} , 1 dB Compression Point ($V_{DD} = 26\text{ Vdc}$, $P_{out} = 90\text{ W CW}$, $f = 1990\text{ MHz}$)	P1dB	—	90	—	W

1. Part is internally matched both on input and output.

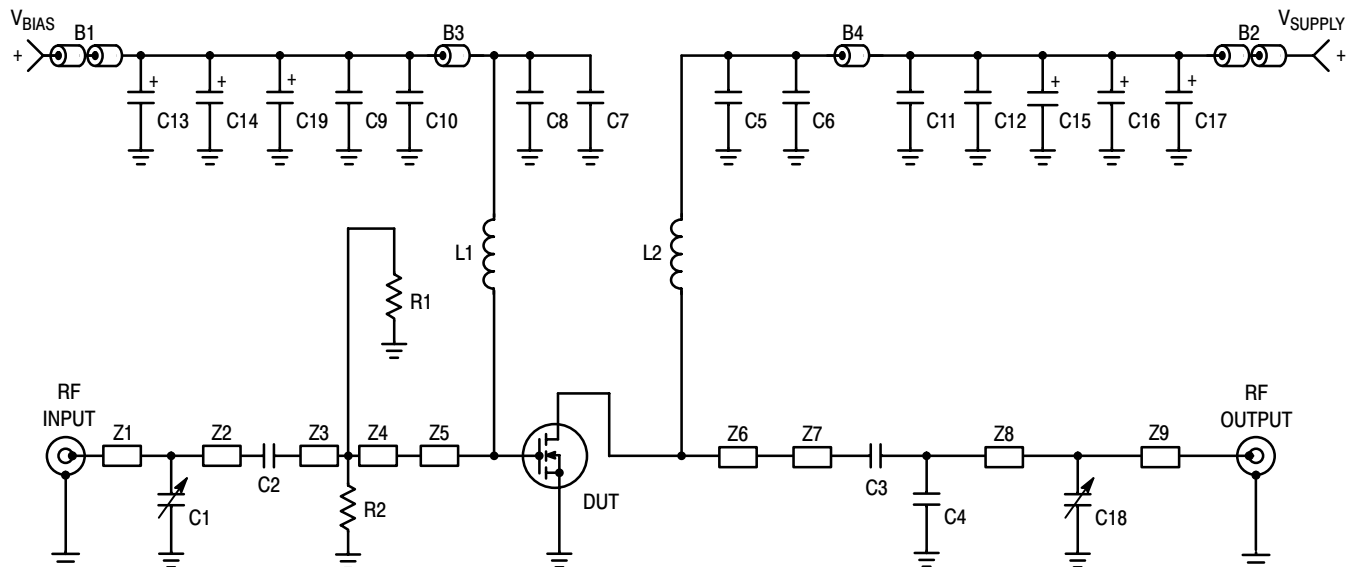

B1, B2	2 Ferrite Beads, Round, Ferroxcube #56-590-65-3B	L1, L2	8 Turns, #26 AWG, 0.085" OD, 0.330" Long, Copper Wire
B3, B34	Ferrite Beads, Surface Mount, Ferroxcube	R1, R2	270 Ω , 1/4 W Chip Resistors, Garrett Instruments #RM73B2B271JT
C1, C18	0.4 - 2.5 pF Variable Capacitors, Johanson Gigatrim #27285	Z1	ZO = 50 Ohms
C2, C5, C8	10 pF Chip Capacitors, ATC #100B100CCA500X	Z2	ZO = 50 Ohms, Lambda = 0.123
C3	12 pF Chip Capacitor, ATC #100B120CCA500X	Z3	ZO = 15.24 Ohms, Lambda = 0.0762
C4	0.3 pF Chip Capacitor, ATC #100B0R3CCA500X	Z4	ZO = 10.11 Ohms, Lambda = 0.0392
C6, C7	120 pF Chip Capacitors, ATC #100B12R1CCA500X	Z5	ZO = 6.34 Ohms, Lambda = 0.0711
C9, C12	0.1 μ F Chip Capacitors, Kemet #CDR33BX104AKWS	Z6	ZO = 5.02 Ohms, Lambda = 0.0476
C10, C11	1000 pF Chip Capacitors, ATC #100B102JCA50X	Z7	ZO = 5.54 Ohms, Lambda = 0.0972
C13, C17	22 μ F, 35 V Tantalum Chip Capacitors, Kemet #T491X226K035AS4394	Z8	ZO = 50.0 Ohms, Lambda = 0.194
C14, C16	10 μ F, 35 V Tantalum Chip Capacitors, Kemet #T495X106K035AS4394	Z9	ZO = 50.0 Ohms
C15, C19	1 μ F, 35 V Tantalum Chip Capacitors, Kemet #T495X105K035AS4394	Raw PCB Material	0.030" Glass Teflon [®] , $\epsilon_r = 2.55$, 2 oz Copper, 3" x 5" Dimensions

Figure 1. MRF19090 Test Circuit Schematic

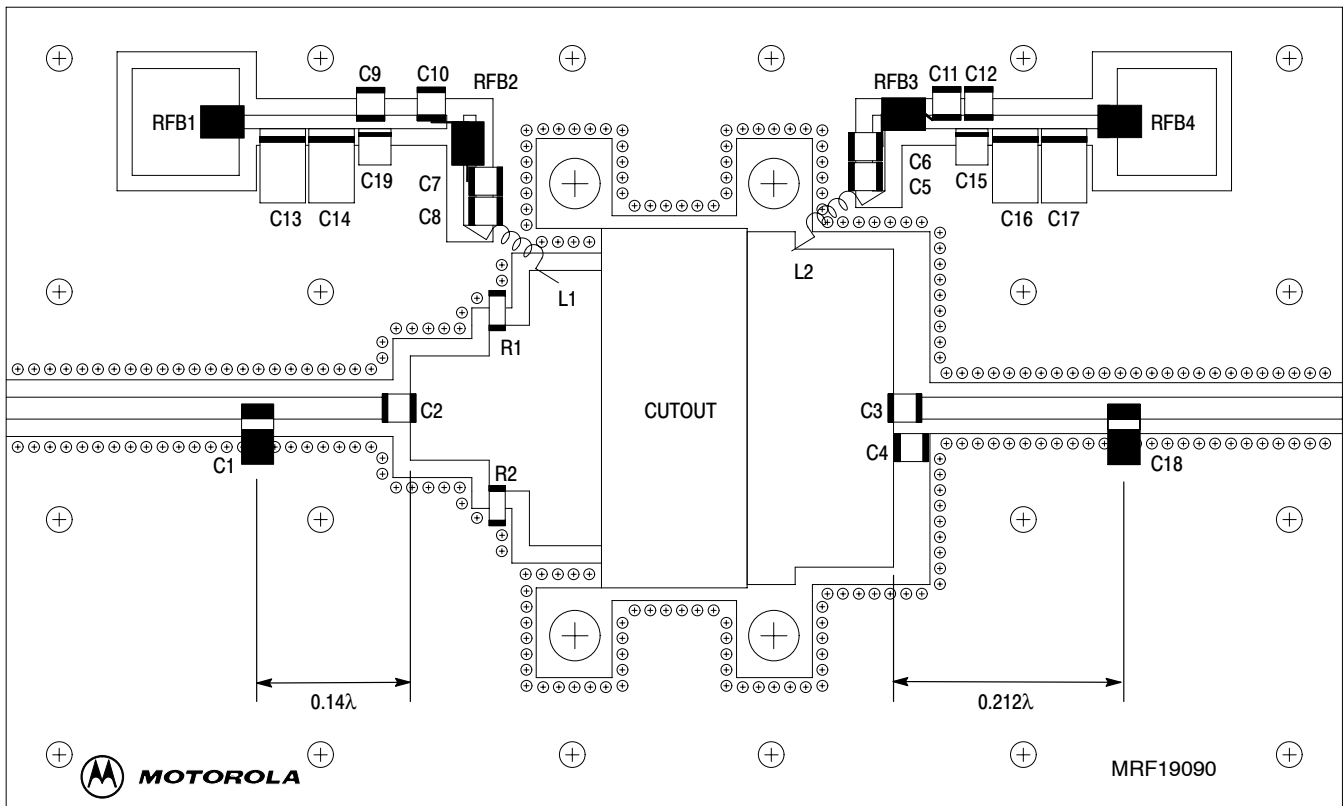

Freescall has begun the transition of marking Printed Circuit Boards (PCBs) with the Freescall Semiconductor signature/logo. PCBs may have either Motorola or Freescall markings during the transition period. These changes will have no impact on form, fit or function of the current product.

Figure 2. MRF19090 Test Circuit Component Layout

TYPICAL CHARACTERISTICS

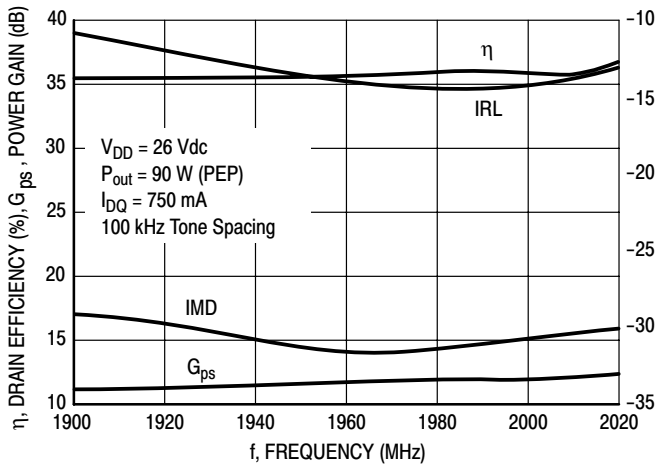

Figure 3. Class AB Performance versus Frequency

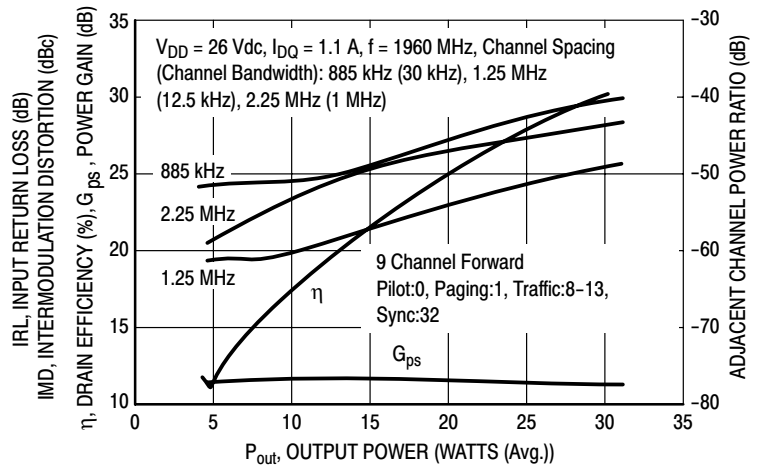

Figure 4. CDMA Performance ACPR, Gain and Drain Efficiency versus Output Power

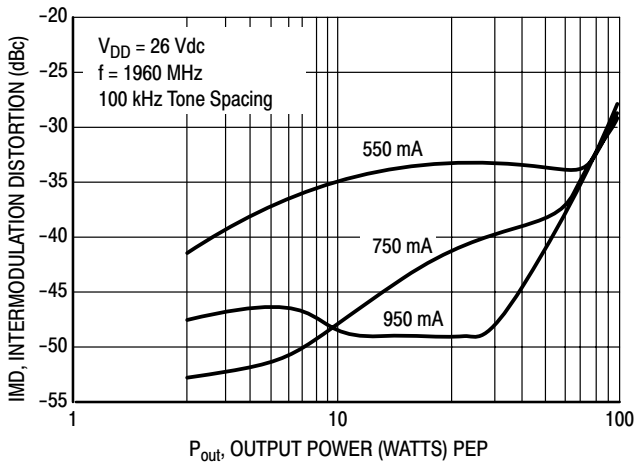

Figure 5. Third Order Intermodulation Distortion versus Output Power

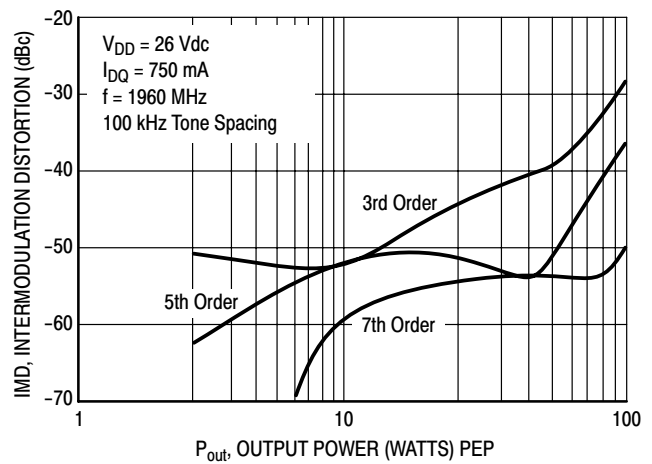

Figure 6. Intermodulation Products versus Output Power

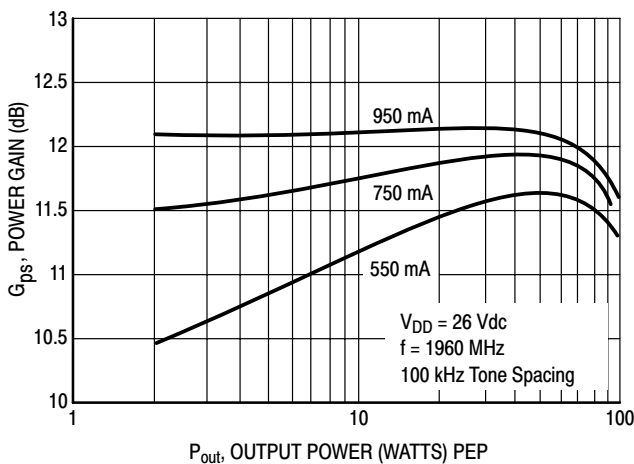

Figure 7. Power Gain versus Output Power

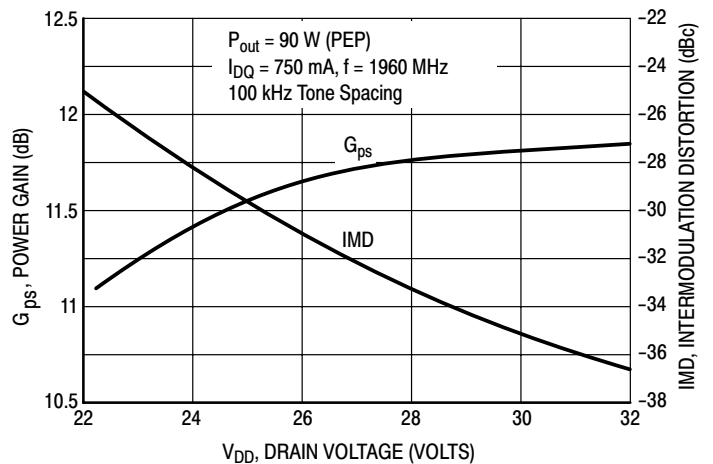
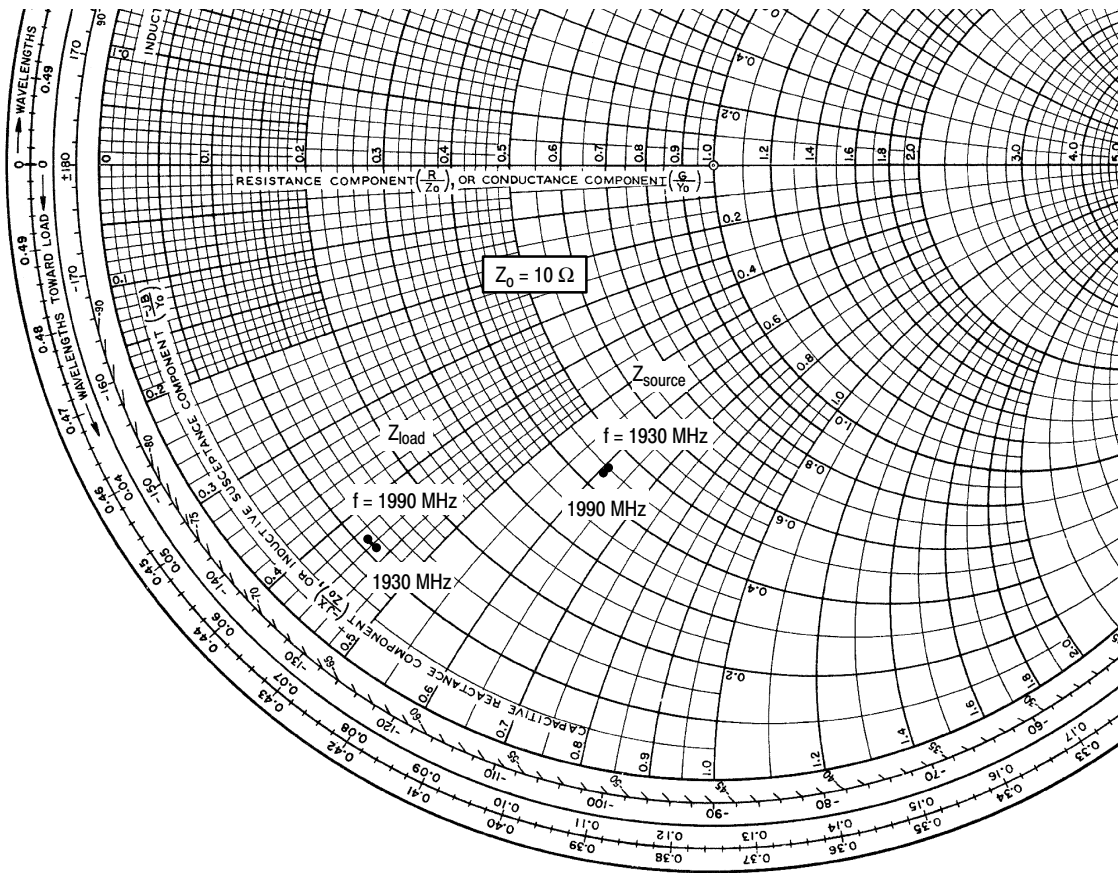

Figure 8. Third Order Intermodulation Distortion and Gain versus Supply Voltage

MRF19090R3 MRF19090SR3



$V_{DD} = 26\text{ V}$, $I_{DQ} = 750\text{ mA}$, $P_{out} = 90\text{ Watts (PEP)}$

f MHz	Z_{source} Ω	Z_{load} Ω
1930	$4.5 - j6.1$	$1.1 - j4.5$
1960	$4.4 - j6.0$	$1.1 - j4.4$
1990	$4.3 - j6.1$	$1.1 - j4.3$

Z_{source} = Test circuit impedance as measured from gate to ground.

Z_{load} = Test circuit impedance as measured from drain to ground.

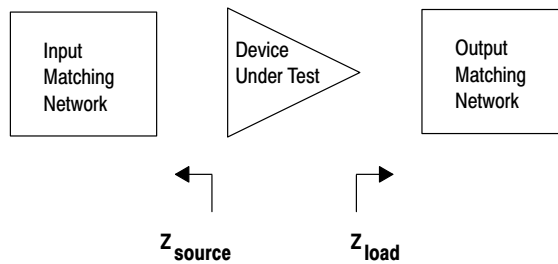
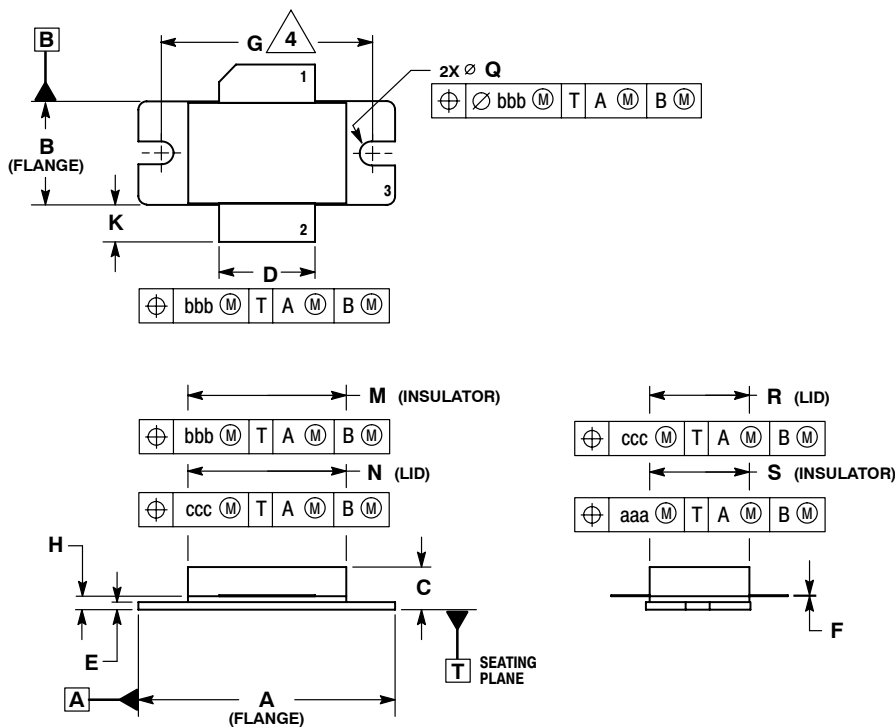

Figure 9. Series Equivalent Source and Load Impedance

PACKAGE DIMENSIONS



- NOTES:
1. DIMENSIONING AND TOLERANCING PER ANSI Y14.5M-1994.
 2. CONTROLLING DIMENSION: INCH.
 3. DIMENSION H IS MEASURED 0.030 (0.762) AWAY FROM PACKAGE BODY.
 4. RECOMMENDED BOLT CENTER DIMENSION OF 1.16 (29.57) BASED ON M3 SCREW.

DIM	INCHES		MILLIMETERS	
	MIN	MAX	MIN	MAX
A	1.335	1.345	33.91	34.16
B	0.535	0.545	13.6	13.8
C	0.147	0.200	3.73	5.08
D	0.495	0.505	12.57	12.83
E	0.035	0.045	0.89	1.14
F	0.003	0.006	0.08	0.15
G	1.100 BSC		27.94 BSC	
H	0.057	0.067	1.45	1.70
K	0.175	0.205	4.44	5.21
M	0.872	0.888	22.15	22.55
N	0.871	0.889	19.30	22.60
Q	\varnothing .118	\varnothing .138	\varnothing 3.00	\varnothing 3.51
R	0.515	0.525	13.10	13.30
S	0.515	0.525	13.10	13.30
aaa	0.007 REF		0.178 REF	
bbb	0.010 REF		0.254 REF	
ccc	0.015 REF		0.381 REF	

- STYLE 1:
- PIN 1. DRAIN
 - GATE
 - SOURCE

**CASE 465B-03
ISSUE D
NI-880
MRF19090R3**

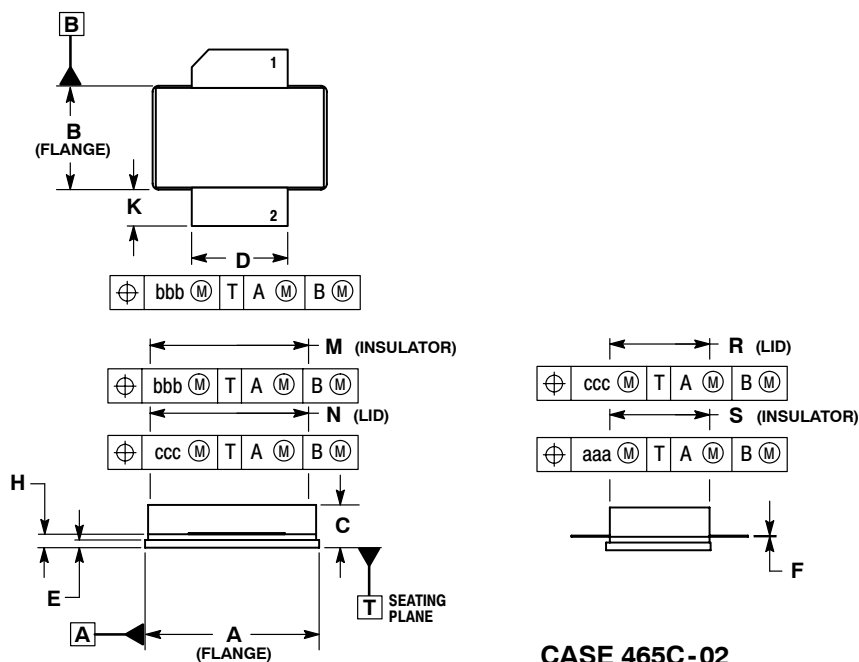

- NOTES:
1. DIMENSIONING AND TOLERANCING PER ANSI Y14.5M-1994.
 2. CONTROLLING DIMENSION: INCH.
 3. DIMENSION H IS MEASURED 0.030 (0.762) AWAY FROM PACKAGE BODY.

DIM	INCHES		MILLIMETERS	
	MIN	MAX	MIN	MAX
A	0.905	0.915	22.99	23.24
B	0.535	0.545	13.60	13.80
C	0.147	0.200	3.73	5.08
D	0.495	0.505	12.57	12.83
E	0.035	0.045	0.89	1.14
F	0.003	0.006	0.08	0.15
H	0.057	0.067	1.45	1.70
K	0.170	0.210	4.32	5.33
M	0.872	0.888	22.15	22.55
N	0.871	0.889	19.30	22.60
R	0.515	0.525	13.10	13.30
S	0.515	0.525	13.10	13.30
aaa	0.007 REF		0.178 REF	
bbb	0.010 REF		0.254 REF	
ccc	0.015 REF		0.381 REF	

- STYLE 1:
- PIN 1. DRAIN
 - GATE
 - SOURCE

**CASE 465C-02
ISSUE D
NI-880S
MRF19090SR3**

MRF19090R3 MRF19090SR3

How to Reach Us:

Home Page:

www.freescale.com

E-mail:

support@freescale.com

USA/Europe or Locations Not Listed:

Freescale Semiconductor
Technical Information Center, CH370
1300 N. Alma School Road
Chandler, Arizona 85224
+1-800-521-6274 or +1-480-768-2130
support@freescale.com

Europe, Middle East, and Africa:

Freescale Halbleiter Deutschland GmbH
Technical Information Center
Schatzbogen 7
81829 Muenchen, Germany
+44 1296 380 456 (English)
+46 8 52200080 (English)
+49 89 92103 559 (German)
+33 1 69 35 48 48 (French)
support@freescale.com

Japan:

Freescale Semiconductor Japan Ltd.
Headquarters
ARCO Tower 15F
1-8-1, Shimo-Meguro, Meguro-ku,
Tokyo 153-0064
Japan
0120 191014 or +81 3 5437 9125
support.japan@freescale.com

Asia/Pacific:

Freescale Semiconductor Hong Kong Ltd.
Technical Information Center
2 Dai King Street
Tai Po Industrial Estate
Tai Po, N.T., Hong Kong
+800 2666 8080
support.asia@freescale.com

For Literature Requests Only:

Freescale Semiconductor Literature Distribution Center
P.O. Box 5405
Denver, Colorado 80217
1-800-441-2447 or 303-675-2140
Fax: 303-675-2150
LDCForFreescaleSemiconductor@hibbertgroup.com

Information in this document is provided solely to enable system and software implementers to use Freescale Semiconductor products. There are no express or implied copyright licenses granted hereunder to design or fabricate any integrated circuits or integrated circuits based on the information in this document.

Freescale Semiconductor reserves the right to make changes without further notice to any products herein. Freescale Semiconductor makes no warranty, representation or guarantee regarding the suitability of its products for any particular purpose, nor does Freescale Semiconductor assume any liability arising out of the application or use of any product or circuit, and specifically disclaims any and all liability, including without limitation consequential or incidental damages. "Typical" parameters that may be provided in Freescale Semiconductor data sheets and/or specifications can and do vary in different applications and actual performance may vary over time. All operating parameters, including "Typicals", must be validated for each customer application by customer's technical experts. Freescale Semiconductor does not convey any license under its patent rights nor the rights of others. Freescale Semiconductor products are not designed, intended, or authorized for use as components in systems intended for surgical implant into the body, or other applications intended to support or sustain life, or for any other application in which the failure of the Freescale Semiconductor product could create a situation where personal injury or death may occur. Should Buyer purchase or use Freescale Semiconductor products for any such unintended or unauthorized application, Buyer shall indemnify and hold Freescale Semiconductor and its officers, employees, subsidiaries, affiliates, and distributors harmless against all claims, costs, damages, and expenses, and reasonable attorney fees arising out of, directly or indirectly, any claim of personal injury or death associated with such unintended or unauthorized use, even if such claim alleges that Freescale Semiconductor was negligent regarding the design or manufacture of the part.

Freescale™ and the Freescale logo are trademarks of Freescale Semiconductor, Inc. All other product or service names are the property of their respective owners.

© Freescale Semiconductor, Inc. 2006. All rights reserved.

