

0.1-10.0 GHz Low Noise, Medium Power pHEMT in a Surface Mount Plastic Package

Features

- ✕ AlGaAs/InGaAs/AlGaAs Pseudomorphic High Electron Mobility Transistor (pHEMT)
- ✕ High Dynamic Range
- ✕ Low Current and Voltage
- ✕ Bias Point 3V and 60 mA
- ✕ 0.3 dB Noise Figure at 2 GHz
- ✕ 17 dBm P1dB at 2 GHz
- ✕ 33 dBm OIP3 at 2 GHz
- ✕ 600 μ m Gate Width: 50 Ω Output Impedance
- ✕ Excellent Uniformity
- ✕ Low-Cost, Surface-Mount Package (SOT-343)
- ✕ Ro-HS Compliant Construction
- ✕ Low Thermal Resistance: 98°C/W



Applications

- ✕ Low Noise Amplifiers and Oscillators Operating over the RF and Microwave Frequency Ranges
- ✕ Cellular/PCS/GSM/W-CDMA
- ✕ Mobile Handsets, Base Station Receivers and Tower-Mount Amplifiers
- ✕ Wimax, WLAN, LEO, GEO, WLL/RLL, GPS and MMDS Applications
- ✕ General Purpose Discrete pHEMT for Other Ultra Low-Noise and Medium Power Applications

Description

Mimix's pHEMT technology is tested and proven in military, space and commercial applications. Mimix's proven workhorse, the CF003-03, has been fabricated in the Company's in-house foundry for over 19 years and is now available in packaged form as the CFS0303-SB.

The CFS0303-SB is a high dynamic range, low-noise, pHEMT packaged in a 4-lead SOT-343 surface-mount plastic package. It is intended for many applications operating in the 0.1GHz to 10GHz frequency range.

Functional Diagram (SOT-343)

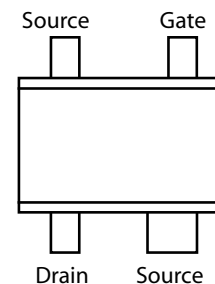

Mimix's high performance packaged pHEMTs are ideal for use in all applications where low-noise figure, high gain, medium power and good intercept is required. The CFS0303-SB is the perfect solution for the first or second stage of a base station LNA due to the excellent combination of low-noise figure and linearity. It is also well suited as a medium power driver stage in pole-top amplifiers and other transmit functions, particularly as the low thermal resistance allows extended power dissipation when voltage and current are adjusted for increased power and linearity.

0.1-10.0 GHz Low Noise, Medium Power pHEMT in a Surface Mount Plastic Package



May 2006 - Rev 23-May-06

CFS0303-SB
RoHS

Electrical Characteristics

Ta=25°C, Typical device RF parameters measured in test system.

Parameters	Test Conditions	Min	Typ	Max	Units		
Saturated Drain Current ¹	Vds=1.5V, Vgs=0V	120	165	200	mA		
Pinch-off Voltage ¹	Vds=1.5V, Ids=10% of Idss	-0.8	-0.65	-0.5	V		
No RF, Quiescent Bias Current	Vgs=0.45V, Vds=2V		60		mA		
Transconductance ¹	Vds=2.5V, Gm=Ids/Vp	190	250		mmho		
Gate to Drain Leakage Current	Vgd = 5			250	μA		
Gate Leakage Current	Vgd=Vgs= -4V		10	150	μA		
Noise Figure	f=1000MHz		Vds=2V, Ids=10mA	0.3		dB	
			Vds=2V, Ids=20mA	0.35		dB	
			Vds=3V, Ids=20mA	0.3	0.7	dB	
	f=2GHz		Vds=3V, Ids=60mA	0.18	0.53	dB	
			Vds=2V, Ids=10mA	0.4		dB	
			Vds=2V, Ids=20mA	0.37		dB	
			Vds=3V, Ids=20mA	0.4	0.8	dB	
			Vds=3V, Ids=60mA	0.26	0.61	dB	
Associated Gain ²	f=1000MHz		Vds=2V, Ids=10mA	19.7		dB	
			Vds=2V, Ids=20mA	20.8		dB	
			Vds=3V, Ids=20mA	21.1		dB	
	f=2GHz		Vds=3V, Ids=60mA	22.4		dB	
			Vds=2V, Ids=10mA	13.1	14.6	16.1	dB
			Vds=2V, Ids=20mA		15.5		dB
			Vds=3V, Ids=20mA		15.7		dB
			Vds=3V, Ids=60mA	15.3	16.8	18.3	dB
Output Third Order Intercept Point	f=1000MHz		Vds=2V, Ids=10mA	22.5		dBm	
			Vds=2V, Ids=20mA	24.5		dBm	
			Vds=3V, Ids=20mA	24.0	26.5		dBm
	f=2GHz		Vds=3V, Ids=60mA	32.0		dBm	
			Vds=2V, Ids=10mA	23.0		dBm	
			Vds=2V, Ids=20mA	25.5		dBm	
			Vds=3V, Ids=20mA	24.5	27.0		dBm
			Vds=3V, Ids=60mA		32.5		dBm
1 dB Gain Compression Point ²	f=1000MHz		Vds=2V, Ids=10mA	12.5		dBm	
			Vds=2V, Ids=20mA	14.0	12.5		dBm
			Vds=3V, Ids=20mA		16.0		dBm
	f=2GHz		Vds=3V, Ids=60mA	17.0		dBm	
			Vds=2V, Ids=10mA	12.5		dBm	
			Vds=2V, Ids=20mA	12.5		dBm	
			Vds=3V, Ids=20mA	14.0	16.0		dBm
			Vds=3V, Ids=60mA		17.0		dBm

Notes:

1. Guaranteed at wafer probe.
2. Measurements obtained at fixed tuned system.

Absolute Maximum Ratings¹

Parameter	Rating	Parameter	Rating	Parameter	Rating
Drain-Source Voltage ²	+5.5 V	Drain Current ²	Idss ³ A	Channel Temperature	+175°C
Gate-Source Voltage ²	-5.0 V	Total Pwr Dissipation	560 mW	Storage Temperature	-65°C to +160°C
Gate-Drain Voltage ²	-5.0 V	RF Input Power	17 dBm	Thermal Resistance	98°C/W

Notes:

1. Operation of this device above any one of these parameters may cause permanent damage
2. Assumes DC quiescent conditions. RF OFF.
3. Vgs=0V

Mimix Broadband, Inc., 10795 Rockley Rd., Houston, Texas 77099
Tel: 281.988.4600 Fax: 281.988.4615 mimixbroadband.com

Page 2 of 17

Characteristic Data and Specifications are subject to change without notice. ©2006 Mimix Broadband, Inc.
Export of this item may require appropriate export licensing from the U.S. Government. In purchasing these parts, U.S. Domestic customers accept their obligation to be compliant with U.S. Export Laws.

0.1-10.0 GHz Low Noise, Medium Power pHEMT in a Surface Mount Plastic Package

Typical Pulsed I-V Performance

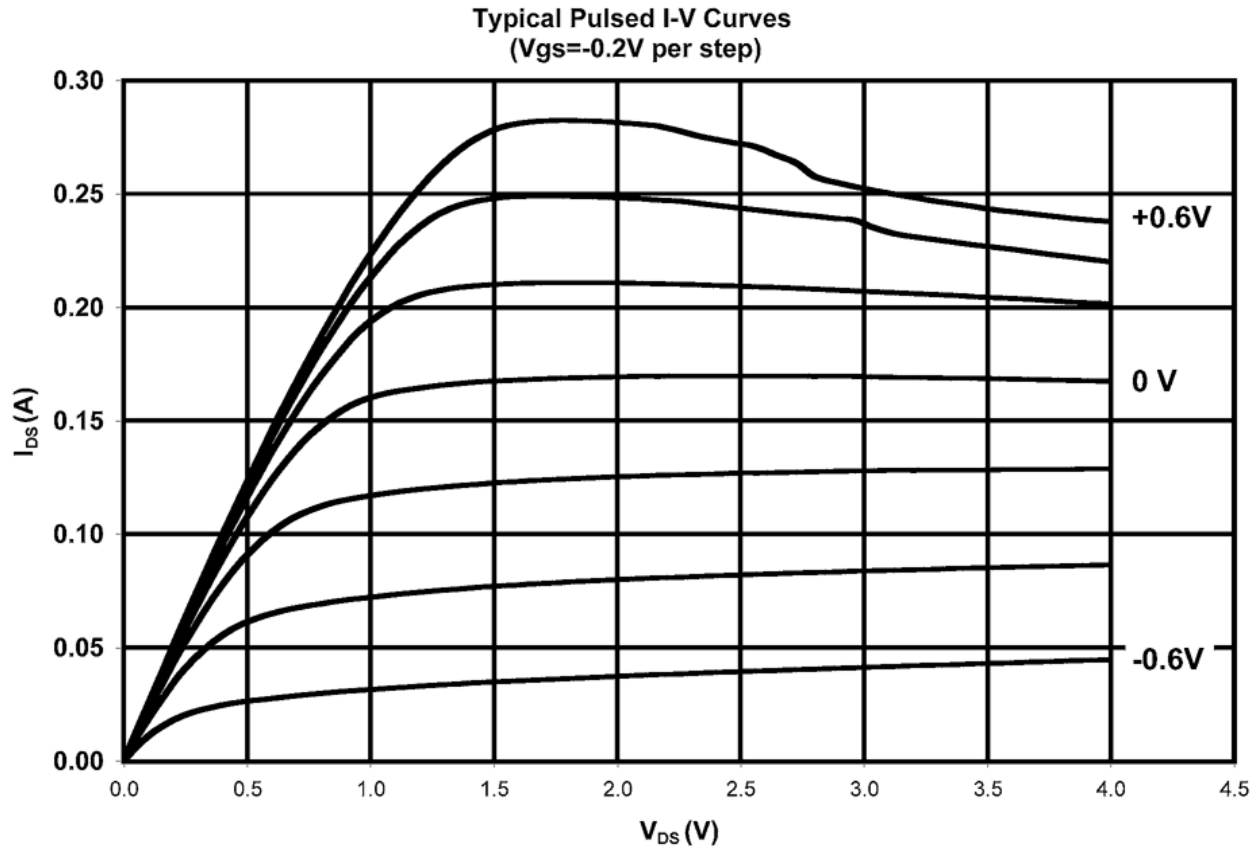

Block diagram of 2.0 GHz production test board used for Noise Figure, Associated Gain, P1dB, and OIP3 measurements.
Circuit Losses have been de-embedded from actual Measurements.

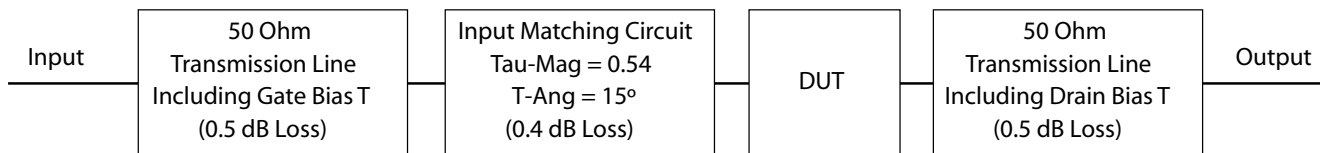

0.1-10.0 GHz Low Noise, Medium Power pHEMT in a Surface Mount Plastic Package

Typical Performance

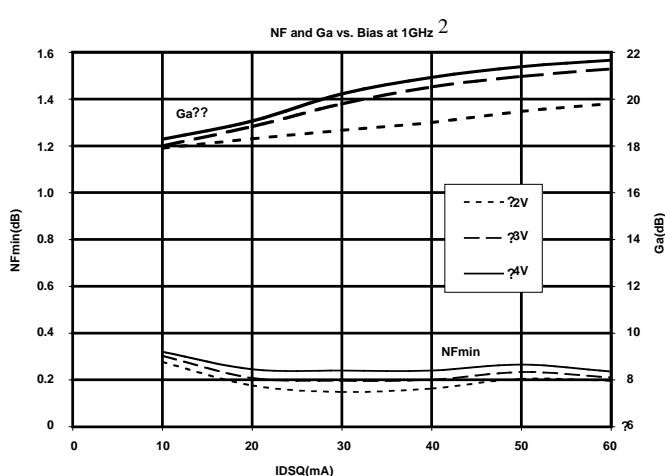
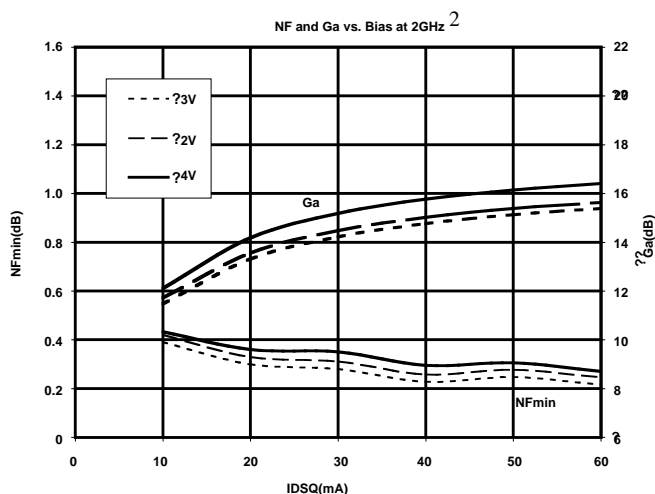
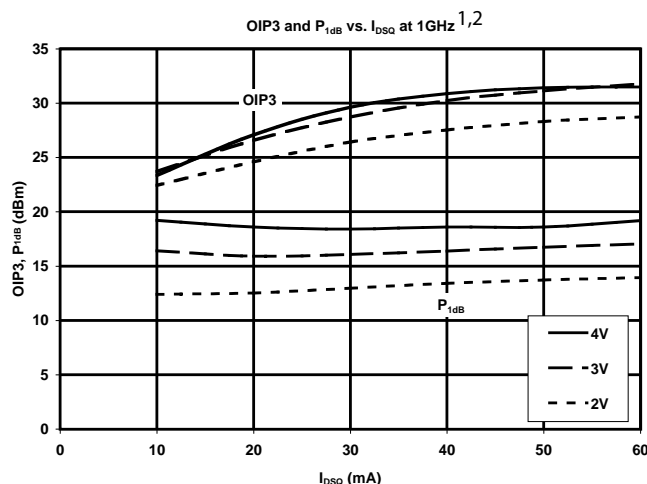
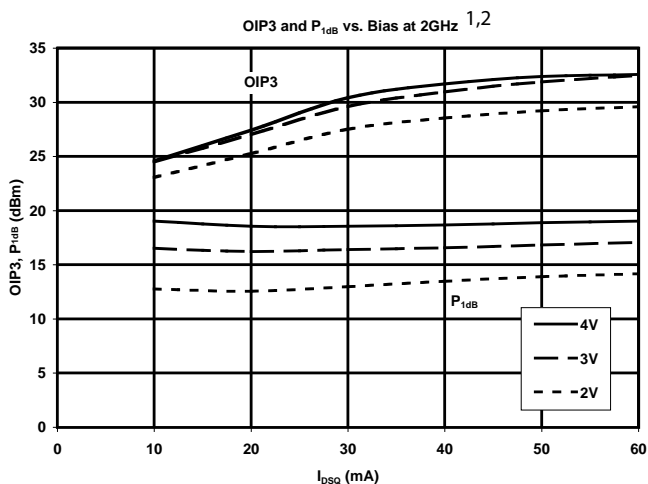

Notes:

1. P_{1dB} and OIP3 measurements are performed with passive biasing. I_{dsq} is set with zero RF drive applied. As P_{1dB} is approached, the drain current may increase or decrease depending on frequency and DC bias point. At lower values of I_{dsq} the device is running in a Class AB mode and current tends to rise as P_{1dB} is approached. As an example, at a V_{ds} = 3.0V and I_{dsq} = 10 mA, I_d increases to 30 mA as P_{1dB} of 16.5 is approached. This rise in current is no longer present as I_{dsq} approaches 60 mA.

2. Measurements made on a fixed tuned test system set for optimum noise match. Circuit losses have been de-embedded for the actual measurements.

0.1-10.0 GHz Low Noise, Medium Power pHEMT in a Surface Mount Plastic Package



May 2006 - Rev 23-May-06

CFS0303-SB
RoHS

Typical Performance

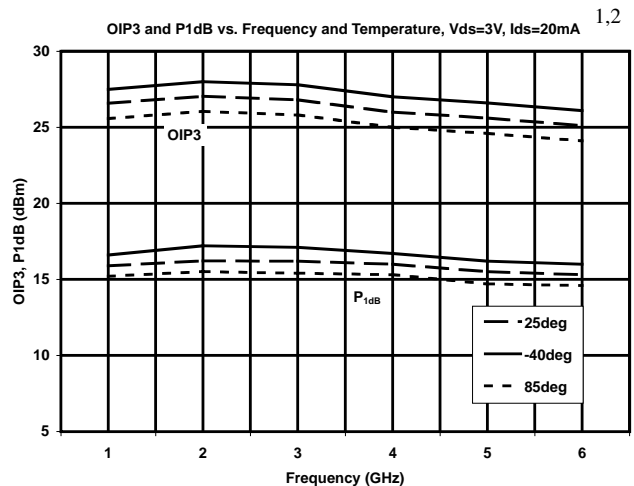
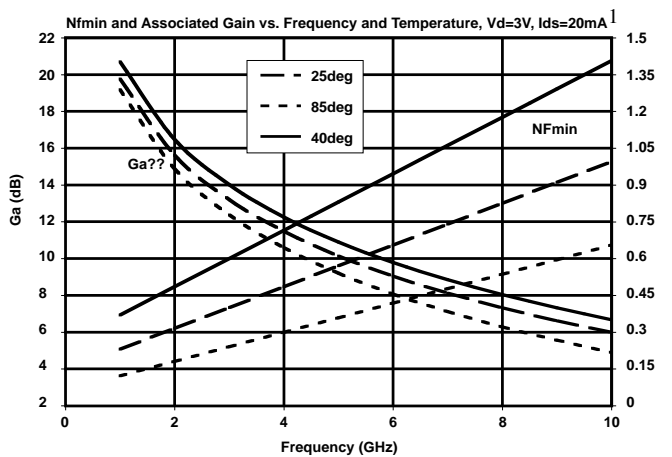
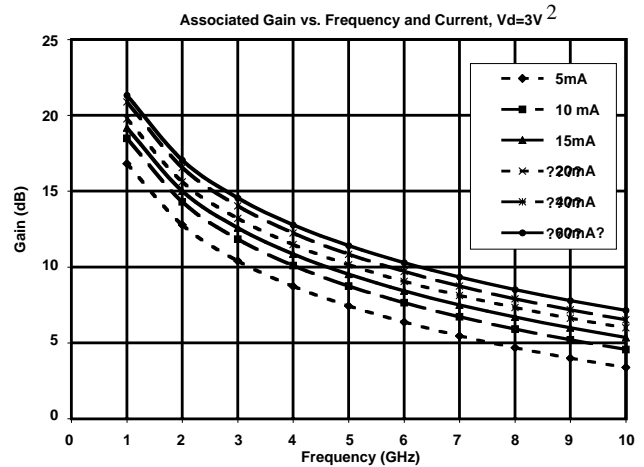
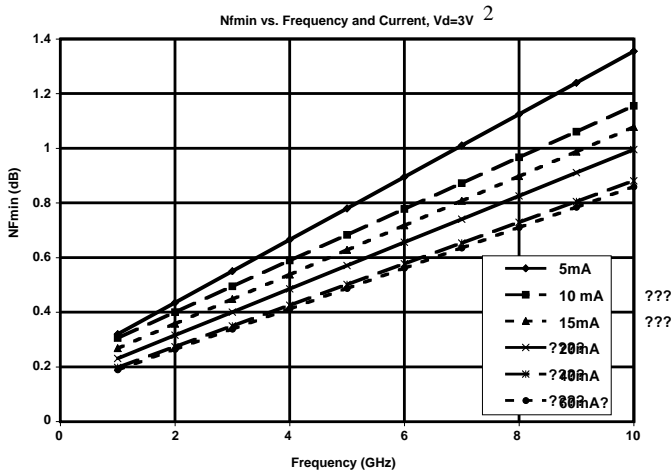

Notes:

1. P1dB and OIP3 measurements are performed with passive biasing. Idsq is set with zero RF drive applied. As P1dB is approached, the drain current may increase or decrease depending on frequency and DC bias point. At lower values of Idsq the device is running in a Class AB mode and current tends to rise as P1dB is approached. As an example, at a Vds = 3.0V and Idsq = 10 mA, Id increases to 30 mA as P1dB of 16.5 is approached. This rise in current is no longer present as Idsq approaches 60 mA.

2. Measurements made on a fixed tuned test system set for optimum noise match. Circuit losses have been de-embedded for the actual measurements.

0.1-10.0 GHz Low Noise, Medium Power pHEMT in a Surface Mount Plastic Package



May 2006 - Rev 23-May-06

CFS0303-SB
 RoHS

Typical Scattering Parameters (V_{ds} = +3.0V, I_{ds} = 10 mA)

Frequency (GHz)	S11			S21			S12		S22		MSG/MAG (dB)
	(Mag)	(Ang)	(dB)	(Mag)	(Ang)	(dB)	(Mag)	(Ang)	(Mag)	(Ang)	
0.50	0.97	-24.46	14.46	5.29	158.76	-27.33	0.04	73.04	0.51	-22.31	20.89
0.75	0.94	-36.01	14.09	5.06	149.37	-24.09	0.06	65.62	0.49	-32.84	19.09
1.00	0.91	-47.10	13.66	4.82	140.56	-21.94	0.08	58.56	0.48	-43.23	17.80
1.25	0.88	-57.86	13.27	4.61	132.32	-20.38	0.10	51.89	0.46	-53.18	16.82
1.50	0.85	-68.46	12.89	4.41	123.86	-19.25	0.11	45.69	0.44	-62.81	16.07
1.75	0.82	-78.22	12.46	4.20	116.31	-18.37	0.12	39.91	0.42	-71.77	15.41
2.00	0.79	-88.31	12.10	4.03	108.89	-17.69	0.13	34.49	0.40	-80.92	14.90
2.25	0.76	-97.35	11.63	3.82	101.93	-17.15	0.14	29.51	0.38	-89.02	14.39
2.50	0.73	-106.45	11.21	3.63	95.14	-16.71	0.15	24.81	0.36	-97.50	13.96
2.75	0.71	-115.41	10.79	3.46	88.51	-16.38	0.15	20.36	0.35	-105.51	13.59
3.00	0.68	-123.45	10.35	3.29	82.45	-16.12	0.16	16.39	0.33	-113.29	13.23
3.25	0.66	-132.06	9.95	3.14	76.31	-15.89	0.16	12.42	0.32	-121.23	12.92
3.50	0.65	-139.54	9.51	2.99	70.78	-15.73	0.16	8.99	0.31	-128.21	12.62
3.75	0.63	-147.21	9.14	2.86	65.09	-15.57	0.17	5.53	0.30	-135.51	12.35
4.00	0.62	-154.41	8.71	2.73	59.68	-15.47	0.17	2.39	0.30	-142.59	12.09
4.25	0.61	-160.96	8.33	2.61	54.74	-15.35	0.17	-0.55	0.29	-148.48	11.84
4.50	0.60	-168.29	7.98	2.51	49.52	-15.28	0.17	-3.46	0.29	-155.85	11.63
4.75	0.59	-174.18	7.59	2.40	44.90	-15.20	0.17	-6.10	0.28	-161.05	11.39
5.00	0.58	-179.24	7.26	2.31	40.03	-15.14	0.17	-8.72	0.28	-168.20	11.20
5.25	0.58	-173.38	6.90	2.21	35.52	-15.09	0.18	-11.19	0.28	-173.14	11.00
5.50	0.58	167.71	6.59	2.13	31.04	-15.04	0.18	-13.57	0.28	-179.08	10.81
5.75	0.57	161.87	6.27	2.06	26.48	-15.00	0.18	-15.84	0.28	175.57	10.64
6.00	0.57	156.96	5.95	1.98	22.32	-14.96	0.18	-18.01	0.29	170.84	10.46
6.25	0.57	151.30	5.69	1.93	18.01	-14.91	0.18	-20.06	0.29	165.54	10.30
6.50	0.57	146.57	5.39	1.86	13.84	-14.88	0.18	-22.26	0.29	160.83	10.13
6.75	0.57	141.67	5.14	1.81	9.77	-14.82	0.18	-24.19	0.29	156.59	9.98
7.00	0.58	136.87	4.86	1.75	5.67	-14.79	0.18	-26.16	0.30	151.68	9.52
7.25	0.58	132.63	4.63	1.70	1.73	-14.73	0.18	-28.08	0.30	148.56	8.82
7.50	0.58	127.80	4.39	1.66	-2.33	-14.69	0.18	-29.85	0.31	143.33	8.43
7.75	0.59	123.93	4.16	1.61	-6.24	-14.59	0.19	-31.61	0.31	140.89	8.15
8.00	0.59	119.46	3.95	1.58	-10.13	-14.51	0.19	-33.67	0.32	135.53	7.83
8.25	0.59	115.41	3.72	1.54	-14.01	-14.46	0.19	-35.65	0.32	132.94	7.58
8.50	0.59	111.63	3.53	1.50	-17.68	-14.38	0.19	-37.43	0.33	128.71	7.33
8.75	0.60	107.21	3.34	1.47	-21.67	-14.31	0.19	-39.52	0.33	125.88	7.16
9.00	0.60	103.71	3.14	1.44	-25.34	-14.22	0.19	-41.26	0.34	121.44	6.97
9.25	0.60	99.52	2.97	1.41	-29.27	-14.13	0.20	-43.26	0.34	118.57	6.78
9.50	0.61	95.94	2.78	1.38	-32.95	-14.05	0.20	-45.09	0.35	114.35	6.65
9.75	0.61	92.21	2.64	1.36	-36.92	-13.93	0.20	-47.17	0.34	112.02	6.52
10.00	0.62	88.33	2.45	1.33	-40.58	-13.86	0.20	-49.05	0.36	107.48	6.37
10.25	0.62	84.89	2.30	1.30	-44.49	-13.75	0.21	-51.22	0.36	105.57	6.25
10.50	0.62	80.72	2.13	1.28	-48.30	-13.65	0.21	-53.31	0.37	100.02	6.08
10.75	0.62	77.40	1.96	1.25	-52.02	-13.57	0.21	-55.46	0.37	98.57	5.96
11.00	0.62	73.36	1.85	1.24	-55.92	-13.40	0.21	-57.73	0.37	93.19	5.81
11.25	0.63	69.90	1.64	1.21	-59.78	-13.35	0.22	-60.02	0.37	91.83	5.70
11.50	0.63	66.02	1.55	1.19	-63.55	-13.20	0.22	-62.33	0.38	86.15	5.52
11.75	0.63	61.82	1.36	1.17	-67.58	-13.15	0.22	-64.91	0.38	83.42	5.42
12.00	0.63	58.57	1.18	1.15	-71.24	-13.06	0.22	-67.04	0.39	78.01	5.08
12.25	0.63	53.75	1.04	1.13	-75.47	-12.96	0.23	-69.90	0.39	75.60	5.03
12.50	0.64	50.83	0.83	1.10	-79.08	-12.91	0.23	-72.09	0.40	69.28	4.76
12.75	0.64	46.04	0.70	1.08	-83.26	-12.79	0.23	-75.03	0.40	68.15	4.62
13.00	0.65	42.24	0.51	1.06	-87.14	-12.74	0.23	-77.59	0.41	61.02	4.47
13.25	0.64	38.95	0.31	1.04	-90.74	-12.69	0.23	-80.00	0.41	60.06	4.23
13.50	0.64	33.67	0.16	1.02	-94.94	-12.59	0.23	-83.07	0.42	52.63	4.01
13.75	0.66	31.19	-0.10	0.99	-98.25	-12.59	0.23	-85.27	0.42	51.62	3.91

Continues Next Page. **S-Parameter Data Files are available on-line at: www.mimixbroadband.com**

Mimix Broadband, Inc., 10795 Rockley Rd., Houston, Texas 77099
 Tel: 281.988.4600 Fax: 281.988.4615 mimixbroadband.com

Page 6 of 17

Characteristic Data and Specifications are subject to change without notice. ©2006 Mimix Broadband, Inc.
 Export of this item may require appropriate export licensing from the U.S. Government. In purchasing these parts, U.S. Domestic customers accept their obligation to be compliant with U.S. Export Laws.

0.1-10.0 GHz Low Noise, Medium Power pHEMT in a Surface Mount Plastic Package



May 2006 - Rev 23-May-06

CFS0303-SB
RoHS

Typical Scattering Parameters (V_{ds} = +3.0V, I_{ds} = 10 mA) (cont.)

Frequency (GHz)	S11			S21			S12			S22		MSG/MAG (dB)
	(Mag)	(Ang)	(dB)	(Mag)	(Ang)	(dB)	(Mag)	(Ang)	(Mag)	(Ang)		
14.00	0.65	26.14	-0.17	0.98	-102.92	-12.44	0.24	-88.84	0.43	42.63	3.68	
14.25	0.66	22.38	-0.51	0.94	-106.23	-12.53	0.24	-91.16	0.44	41.81	3.51	
14.50	0.66	19.49	-0.68	0.92	-109.92	-12.46	0.24	-93.89	0.44	34.57	3.14	
14.75	0.66	13.16	-0.94	0.90	-114.26	-12.49	0.24	-97.26	0.45	32.54	2.95	
15.00	0.67	11.67	-1.17	0.87	-117.54	-12.50	0.24	-99.63	0.46	24.27	2.70	
15.25	0.67	6.13	-1.39	0.85	-121.26	-12.48	0.24	-102.52	0.46	23.91	2.45	
15.50	0.68	2.58	-1.66	0.83	-125.44	-12.54	0.24	-105.85	0.48	15.13	2.27	
15.75	0.68	-0.96	-1.88	0.81	-128.01	-12.53	0.24	-107.64	0.47	16.38	2.03	
16.00	0.69	-6.10	-2.16	0.78	-132.71	-12.58	0.23	-111.57	0.49	7.47	1.86	
16.25	0.69	-8.23	-2.41	0.76	-134.95	-12.64	0.23	-113.14	0.50	8.13	1.68	
16.50	0.69	-13.18	-2.68	0.73	-139.42	-12.69	0.23	-116.84	0.51	-0.99	1.36	
16.75	0.71	-16.33	-2.97	0.71	-142.13	-12.75	0.23	-118.83	0.52	-0.39	1.37	
17.00	0.70	-18.86	-3.22	0.69	-145.33	-12.81	0.23	-121.53	0.53	-7.59	1.01	
17.25	0.72	-23.21	-3.47	0.67	-148.62	-12.85	0.23	-124.24	0.55	-7.71	1.05	
17.50	0.72	-25.01	-3.80	0.65	-151.65	-12.98	0.22	-126.69	0.56	-14.49	0.78	
17.75	0.73	-28.74	-3.98	0.63	-154.37	-12.98	0.22	-128.84	0.57	-13.61	0.77	
18.00	0.74	-31.05	-4.34	0.61	-157.49	-13.11	0.22	-131.43	0.59	-20.26	0.55	

S-Parameter Data Files are available on-line at: www.mimixbroadband.com

CFS0303-SB Typical Noise Parameters (V_{ds} = +3.0V, I_{ds} = 10 mA)

Freq. GHz	NFmin db	Gamma Opt		Rn	Ga db
		Mag.	Ang.		
1.0	0.31	0.81	32.38	16.42	18.75
2.0	0.40	0.72	70.42	12.56	15.32
3.0	0.49	0.59	80.53	8.45	11.46
4.0	0.59	0.51	124.41	5.93	10.33
5.0	0.68	0.47	148.67	3.23	8.64
6.0	0.78	0.44	175.26	2.28	7.36
7.0	0.87	0.44	-157.76	4.34	6.55
8.0	0.97	0.44	-124.27	8.84	5.86
9.0	1.06	0.46	-118.20	9.77	5.09
10.0	1.16	0.46	-96.05	13.98	4.46

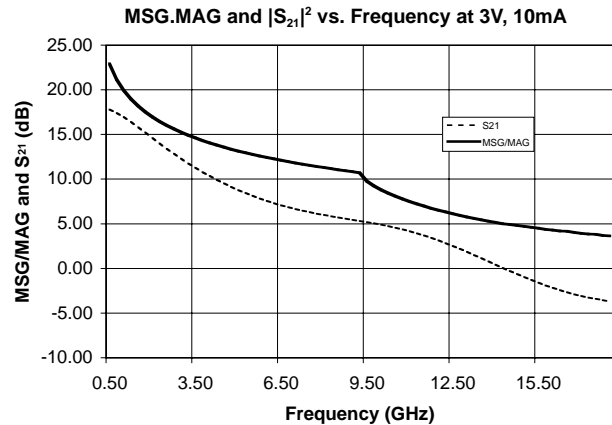

0.1-10.0 GHz Low Noise, Medium Power pHEMT in a Surface Mount Plastic Package



May 2006 - Rev 23-May-06

CFS0303-SB
 RoHS

Typical Scattering Parameters (V_{ds} = +3.0V, I_{ds} = 20 mA)

Frequency (GHz)	S11			S21			S12			S22		MSG/MAG (dB)
	(Mag)	(Ang)	(dB)	(Mag)	(Ang)	(dB)	(Mag)	(Ang)	(Mag)	(Ang)		
0.50	0.96	-28.72	17.33	7.35	157.64	-28.79	0.04	72.31	0.34	-30.97	23.06	
0.75	0.92	-42.33	16.97	7.06	147.39	-25.66	0.05	64.83	0.32	-45.26	21.31	
1.00	0.88	-55.38	16.55	6.72	137.60	-23.62	0.07	58.08	0.31	-58.80	20.09	
1.25	0.84	-67.83	16.10	6.38	128.60	-22.18	0.08	51.91	0.30	-72.09	19.14	
1.50	0.80	-79.84	15.66	6.06	119.66	-21.12	0.09	46.44	0.29	-84.14	18.39	
1.75	0.76	-90.67	15.13	5.71	111.69	-20.31	0.10	41.55	0.28	-95.43	17.72	
2.00	0.73	-101.41	14.63	5.39	103.90	-19.67	0.10	37.10	0.27	-106.38	17.15	
2.25	0.70	-111.05	14.06	5.05	96.98	-19.15	0.11	33.19	0.26	-116.04	16.61	
2.50	0.67	-120.43	13.50	4.73	90.36	-18.72	0.12	29.53	0.25	-126.02	16.11	
2.75	0.64	-129.44	12.97	4.45	84.14	-18.35	0.12	26.15	0.25	-135.00	15.66	
3.00	0.62	-137.67	12.45	4.19	78.38	-18.03	0.13	23.17	0.25	-143.35	15.24	
3.25	0.61	-146.19	11.94	3.95	72.59	-17.74	0.13	20.17	0.24	-152.10	14.84	
3.50	0.59	-153.55	11.45	3.74	67.38	-17.49	0.13	17.62	0.24	-159.04	14.47	
3.75	0.58	-160.94	10.99	3.54	62.13	-17.24	0.14	15.01	0.24	-166.87	14.12	
4.00	0.57	-167.99	10.53	3.36	57.14	-17.03	0.14	12.55	0.25	-173.12	13.78	
4.25	0.56	-174.28	10.09	3.20	52.55	-16.80	0.14	10.26	0.24	-179.40	13.45	
4.50	0.56	178.80	9.68	3.05	47.76	-16.60	0.15	7.86	0.25	174.45	13.14	
4.75	0.55	173.18	9.27	2.91	43.44	-16.40	0.15	5.79	0.25	169.09	12.84	
5.00	0.55	166.86	8.90	2.79	38.94	-16.20	0.15	3.50	0.26	163.37	12.55	
5.25	0.55	161.43	8.51	2.66	34.76	-16.04	0.16	1.41	0.26	158.53	12.27	
5.50	0.55	156.07	8.17	2.56	30.54	-15.85	0.16	-0.73	0.26	153.63	12.01	
5.75	0.55	150.61	7.83	2.46	26.32	-15.68	0.16	-2.88	0.27	148.90	11.76	
6.00	0.55	145.92	7.51	2.37	22.39	-15.51	0.17	-4.92	0.27	145.13	11.03	
6.25	0.55	140.65	7.21	2.29	18.37	-15.33	0.17	-7.01	0.28	140.46	10.42	
6.50	0.55	136.25	6.90	2.21	14.47	-15.16	0.17	-9.15	0.28	136.59	9.97	
6.75	0.55	131.64	6.64	2.15	10.61	-14.98	0.18	-11.24	0.28	132.72	9.56	
7.00	0.56	127.13	6.35	2.08	6.77	-14.84	0.18	-13.34	0.29	128.96	9.24	
7.25	0.56	123.25	6.11	2.02	2.98	-14.66	0.18	-15.45	0.29	125.68	8.94	
7.50	0.56	118.70	5.84	1.96	-0.85	-14.51	0.19	-17.53	0.30	121.85	8.68	
7.75	0.56	115.07	5.62	1.91	-4.61	-14.31	0.19	-19.55	0.30	119.17	8.46	
8.00	0.57	110.87	5.38	1.86	-8.31	-14.15	0.20	-21.94	0.31	114.96	8.20	
8.25	0.57	107.01	5.17	1.81	-11.99	-13.99	0.20	-24.32	0.31	112.65	8.01	
8.50	0.57	103.44	4.96	1.77	-15.51	-13.83	0.20	-26.46	0.32	108.94	7.79	
8.75	0.58	99.28	4.76	1.73	-19.33	-13.68	0.21	-28.95	0.32	106.56	7.63	
9.00	0.58	95.95	4.57	1.69	-22.88	-13.52	0.21	-31.19	0.33	102.74	7.46	
9.25	0.58	91.98	4.38	1.66	-26.67	-13.37	0.21	-33.62	0.33	100.01	7.29	
9.50	0.59	88.68	4.19	1.62	-30.25	-13.23	0.22	-35.91	0.34	96.31	7.16	
9.75	0.59	85.14	4.05	1.59	-34.14	-13.06	0.22	-38.55	0.33	94.09	7.04	
10.00	0.59	81.43	3.85	1.56	-37.63	-12.94	0.23	-40.86	0.34	90.20	6.90	
10.25	0.59	78.18	3.70	1.53	-41.49	-12.79	0.23	-43.56	0.34	88.41	6.77	
10.50	0.59	74.17	3.53	1.50	-45.13	-12.66	0.23	-46.10	0.35	83.52	6.61	
10.75	0.60	71.06	3.35	1.47	-48.81	-12.54	0.24	-48.69	0.35	82.04	6.48	
11.00	0.60	67.20	3.24	1.45	-52.64	-12.37	0.24	-51.50	0.35	77.04	6.34	
11.25	0.60	63.95	3.03	1.42	-56.35	-12.30	0.24	-54.24	0.35	76.02	6.24	
11.50	0.60	60.21	2.93	1.40	-60.07	-12.13	0.25	-56.99	0.37	70.56	6.05	
11.75	0.60	56.21	2.73	1.37	-64.00	-12.07	0.25	-59.95	0.36	68.23	5.94	
12.00	0.60	53.08	2.57	1.34	-67.54	-11.98	0.25	-62.57	0.37	63.04	5.64	
12.25	0.61	48.44	2.41	1.32	-71.71	-11.88	0.25	-65.84	0.37	60.99	5.58	
12.50	0.61	45.68	2.22	1.29	-75.17	-11.83	0.26	-68.39	0.38	54.86	5.34	
12.75	0.61	40.99	2.08	1.27	-79.33	-11.71	0.26	-71.70	0.37	53.94	5.21	
13.00	0.62	37.43	1.89	1.24	-83.05	-11.68	0.26	-74.59	0.39	47.24	5.07	
13.25	0.62	34.21	1.71	1.22	-86.62	-11.62	0.26	-77.35	0.39	46.32	4.84	
13.50	0.62	29.08	1.55	1.20	-90.72	-11.55	0.26	-80.69	0.40	39.34	4.63	
13.75	0.63	26.80	1.32	1.16	-93.93	-11.56	0.26	-83.22	0.39	38.57	4.55	

Continues Next Page. **S-Parameter Data Files are available on-line at: www.mimixbroadband.com**

Mimix Broadband, Inc., 10795 Rockley Rd., Houston, Texas 77099
 Tel: 281.988.4600 Fax: 281.988.4615 mimixbroadband.com

Page 8 of 17

Characteristic Data and Specifications are subject to change without notice. ©2006 Mimix Broadband, Inc.
 Export of this item may require appropriate export licensing from the U.S. Government. In purchasing these parts, U.S. Domestic customers accept their obligation to be compliant with U.S. Export Laws.

0.1-10.0 GHz Low Noise, Medium Power pHEMT in a Surface Mount Plastic Package



May 2006 - Rev 23-May-06

CFS0303-SB
RoHS

Typical Scattering Parameters (Vds = +3.0V, Ids = 20 mA) (cont.)

Frequency (GHz)	S11			S21			S12			S22		MSG/MAG (dB)
	(Mag)	(Ang)	(dB)	(Mag)	(Ang)	(dB)	(Mag)	(Ang)	(Mag)	(Ang)		
14.00	0.63	21.85	1.23	1.15	-98.55	-11.42	0.27	-87.09	0.41	29.75	4.32	
14.25	0.64	18.26	0.91	1.11	-101.78	-11.52	0.27	-89.60	0.42	29.51	4.17	
14.50	0.63	15.40	0.76	1.09	-105.37	-11.47	0.27	-92.61	0.42	22.41	3.86	
14.75	0.64	9.20	0.51	1.06	-109.64	-11.51	0.27	-96.16	0.43	20.78	3.69	
15.00	0.65	7.91	0.29	1.03	-112.87	-11.53	0.27	-98.73	0.44	12.71	3.46	
15.25	0.65	2.31	0.10	1.01	-116.52	-11.53	0.27	-101.84	0.44	12.78	3.26	
15.50	0.66	-0.98	-0.17	0.98	-120.62	-11.60	0.26	-105.31	0.46	4.31	3.09	
15.75	0.66	-4.51	-0.36	0.96	-123.18	-11.60	0.26	-107.28	0.45	5.92	2.89	
16.00	0.67	-9.56	-0.61	0.93	-127.79	-11.68	0.26	-111.36	0.48	-2.61	2.74	
16.25	0.67	-11.64	-0.84	0.91	-130.09	-11.73	0.26	-113.09	0.47	-1.69	2.58	
16.50	0.68	-16.49	-1.09	0.88	-134.47	-11.80	0.26	-116.91	0.50	-10.40	2.31	
16.75	0.69	-19.60	-1.33	0.86	-137.19	-11.86	0.26	-119.05	0.50	-9.41	2.32	
17.00	0.69	-22.08	-1.58	0.83	-140.44	-11.93	0.25	-121.87	0.51	-16.41	1.99	
17.25	0.70	-26.34	-1.79	0.81	-143.72	-11.98	0.25	-124.68	0.52	-16.02	2.03	
17.50	0.71	-28.05	-2.07	0.79	-146.74	-12.11	0.25	-127.29	0.54	-22.59	1.81	
17.75	0.71	-31.75	-2.23	0.77	-149.58	-12.10	0.25	-129.55	0.54	-21.39	1.80	
18.00	0.72	-33.97	-2.55	0.75	-152.76	-12.25	0.24	-132.30	0.56	-27.74	1.61	

S-Parameter Data Files are available on-line at: www.mimixbroadband.com

CFS0303-SB Typical Noise Parameters

(Vds = +3.0V, Ids = 20 mA)

Freq. GHz	NFmin db	Gamma Mag.	Opt Ang.	Rn	Ga db
1.0	0.23	0.75	40.32	9.37	18.33
2.0	0.32	0.63	60.24	8.11	15.44
3.0	0.40	0.55	81.86	5.61	12.60
4.0	0.49	0.46	131.10	4.04	11.21
5.0	0.57	0.46	162.82	3.12	10.10
6.0	0.66	0.49	-169.24	2.10	8.72
7.0	0.74	0.52	-139.47	2.62	7.99
8.0	0.83	0.49	-124.52	6.38	7.03
9.0	0.91	0.54	-111.59	7.75	6.56
10.0	1.00	0.56	-95.09	9.64	6.00

MSG.MAG and |S₂₁|² vs. Frequency at 3V, 20mA

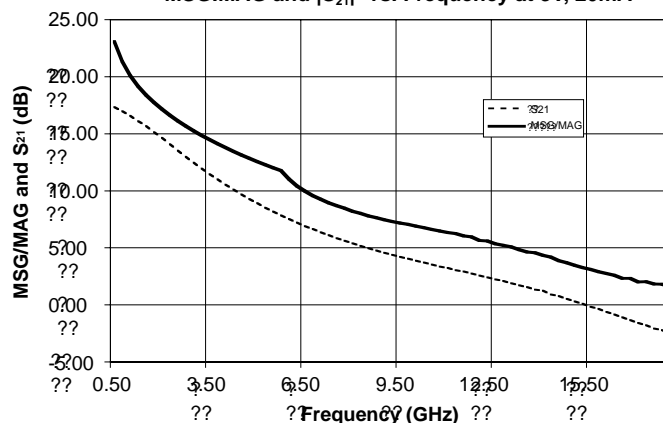

0.1-10.0 GHz Low Noise, Medium Power pHEMT in a Surface Mount Plastic Package



May 2006 - Rev 23-May-06

CFS0303-SB
 RoHS

Typical Scattering Parameters (V_{ds} = +3.0V, I_{ds} = 40 mA)

Frequency (GHz)	S11			S21			S12			S22		MSG/MAG (dB)
	(Mag)	(Ang)	(dB)	(Mag)	(Ang)	(dB)	(Mag)	(Ang)	(Mag)	(Ang)		
0.50	0.95	-32.87	19.45	9.38	156.07	-30.13	0.03	72.31	0.22	-43.47	24.79	
0.75	0.90	-48.30	19.01	8.93	144.86	-27.06	0.04	65.18	0.21	-62.51	23.04	
1.00	0.85	-62.72	18.47	8.38	134.27	-25.09	0.06	58.98	0.21	-79.64	21.78	
1.25	0.80	-76.26	17.89	7.84	124.67	-23.69	0.07	53.62	0.21	-95.91	20.79	
1.50	0.76	-88.89	17.32	7.34	115.60	-22.65	0.07	48.97	0.21	-109.49	19.98	
1.75	0.71	-100.16	16.68	6.82	107.56	-21.83	0.08	45.00	0.21	-121.85	19.25	
2.00	0.68	-111.03	16.06	6.35	99.92	-21.15	0.09	41.41	0.21	-132.92	18.60	
2.25	0.65	-120.71	15.40	5.89	93.21	-20.57	0.09	38.34	0.21	-142.54	17.99	
2.50	0.62	-130.18	14.78	5.48	86.84	-20.06	0.10	35.36	0.22	-151.87	17.42	
2.75	0.60	-138.99	14.16	5.11	80.99	-19.61	0.10	32.68	0.22	-160.24	16.89	
3.00	0.58	-147.10	13.59	4.78	75.50	-19.19	0.11	30.20	0.22	-167.54	16.39	
3.25	0.57	-155.41	13.04	4.49	70.03	-18.81	0.11	27.61	0.23	-175.38	15.92	
3.50	0.56	-162.50	12.50	4.22	65.10	-18.45	0.12	25.41	0.23	-178.95	15.48	
3.75	0.55	-169.71	12.02	3.99	60.12	-18.10	0.12	23.04	0.24	-172.01	15.06	
4.00	0.54	-176.45	11.52	3.77	55.45	-17.79	0.13	20.79	0.24	-167.17	14.65	
4.25	0.54	-177.45	11.07	3.58	51.06	-17.47	0.13	18.62	0.24	-161.48	14.27	
4.50	0.53	-170.85	10.63	3.40	46.56	-17.17	0.14	16.27	0.26	-156.72	13.90	
4.75	0.53	-165.50	10.21	3.24	42.44	-16.88	0.14	14.17	0.25	-151.85	13.54	
5.00	0.53	-159.46	9.82	3.10	38.18	-16.60	0.15	11.86	0.27	-147.39	13.21	
5.25	0.53	-154.33	9.42	2.96	34.22	-16.35	0.15	9.70	0.27	-143.02	12.38	
5.50	0.53	-149.12	9.07	2.84	30.17	-16.08	0.16	7.44	0.27	-138.99	11.78	
5.75	0.53	-144.00	8.71	2.73	26.15	-15.85	0.16	5.19	0.28	-134.78	11.26	
6.00	0.53	-139.47	8.39	2.63	22.36	-15.60	0.17	2.98	0.28	-131.67	10.84	
6.25	0.54	-134.47	8.08	2.53	18.52	-15.36	0.17	0.69	0.29	-127.49	10.45	
6.50	0.54	-130.22	7.77	2.44	14.80	-15.14	0.18	-1.60	0.30	-124.30	10.12	
6.75	0.54	-125.84	7.49	2.37	11.06	-14.90	0.18	-3.93	0.30	-120.59	9.79	
7.00	0.55	-121.56	7.19	2.29	7.37	-14.71	0.18	-6.25	0.31	-117.51	9.51	
7.25	0.55	-117.82	6.95	2.23	3.69	-14.48	0.19	-8.62	0.30	-114.15	9.25	
7.50	0.55	-113.42	6.68	2.16	-0.01	-14.29	0.19	-10.98	0.32	-111.02	9.00	
7.75	0.55	-109.96	6.45	2.10	-3.66	-14.07	0.20	-13.32	0.31	-108.13	8.78	
8.00	0.56	-105.90	6.21	2.04	-7.23	-13.87	0.20	-15.83	0.32	-104.61	8.55	
8.25	0.56	-102.21	5.99	1.99	-10.83	-13.69	0.21	-18.38	0.32	-102.40	8.36	
8.50	0.56	-98.76	5.78	1.95	-14.24	-13.49	0.21	-20.79	0.33	-98.96	8.15	
8.75	0.57	-94.73	5.58	1.90	-17.98	-13.31	0.22	-23.53	0.33	-96.74	8.00	
9.00	0.57	-91.54	5.38	1.86	-21.44	-13.13	0.22	-26.00	0.34	-93.19	7.82	
9.25	0.57	-87.70	5.19	1.82	-25.15	-12.96	0.22	-28.69	0.34	-90.62	7.66	
9.50	0.57	-84.52	5.00	1.78	-28.64	-12.80	0.23	-31.18	0.35	-87.17	7.52	
9.75	0.58	-81.08	4.85	1.75	-32.48	-12.62	0.23	-34.08	0.34	-84.80	7.40	
10.00	0.58	-77.50	4.65	1.71	-35.87	-12.49	0.24	-36.57	0.35	-81.39	7.26	
10.25	0.58	-74.35	4.50	1.68	-39.68	-12.33	0.24	-39.52	0.34	-79.47	7.13	
10.50	0.58	-70.51	4.32	1.64	-43.23	-12.19	0.25	-42.26	0.36	-75.06	6.95	
10.75	0.58	-67.46	4.15	1.61	-46.82	-12.06	0.25	-45.08	0.35	-73.55	6.83	
11.00	0.58	-63.75	4.02	1.59	-50.60	-11.89	0.25	-48.10	0.36	-68.75	6.69	
11.25	0.59	-60.61	3.82	1.55	-54.25	-11.81	0.26	-51.01	0.36	-67.78	6.59	
11.50	0.58	-56.95	3.72	1.53	-57.90	-11.65	0.26	-53.95	0.37	-62.37	6.40	
11.75	0.59	-53.07	3.52	1.50	-61.78	-11.59	0.26	-57.05	0.37	-60.37	6.29	
12.00	0.59	-50.06	3.34	1.47	-65.26	-11.49	0.27	-59.84	0.38	-55.24	6.01	
12.25	0.59	-45.52	3.19	1.44	-69.33	-11.39	0.27	-63.26	0.37	-53.44	5.95	
12.50	0.60	-42.87	2.99	1.41	-72.73	-11.34	0.27	-65.97	0.38	-47.52	5.71	
12.75	0.60	-38.22	2.86	1.39	-76.79	-11.23	0.27	-69.43	0.38	-46.67	5.60	
13.00	0.61	-34.89	2.66	1.36	-80.44	-11.20	0.28	-72.41	0.40	-40.15	5.45	
13.25	0.60	-31.63	2.49	1.33	-83.96	-11.14	0.28	-75.33	0.39	-39.17	5.24	
13.50	0.61	-26.61	2.32	1.31	-87.98	-11.07	0.28	-78.76	0.41	-32.50	5.04	
13.75	0.62	-24.40	2.09	1.27	-91.15	-11.09	0.28	-81.41	0.40	-31.83	4.95	

Continues Next Page. **S-Parameter Data Files are available on-line at: www.mimixbroadband.com**

Mimix Broadband, Inc., 10795 Rockley Rd., Houston, Texas 77099
 Tel: 281.988.4600 Fax: 281.988.4615 mimixbroadband.com

Page 10 of 17

Characteristic Data and Specifications are subject to change without notice. ©2006 Mimix Broadband, Inc.
 Export of this item may require appropriate export licensing from the U.S. Government. In purchasing these parts, U.S. Domestic customers accept their obligation to be compliant with U.S. Export Laws.

0.1-10.0 GHz Low Noise, Medium Power pHEMT in a Surface Mount Plastic Package



May 2006 - Rev 23-May-06

CFS0303-SB
RoHS

Typical Scattering Parameters ($V_{ds} = +3.0V, I_{ds} = 40 \text{ mA}$) (cont.)

Frequency (GHz)	S11			S21			S12			S22		MSG/MAG (dB)
	(Mag)	(Ang)	(dB)	(Mag)	(Ang)	(dB)	(Mag)	(Ang)	(Mag)	(Ang)		
14.00	0.62	19.53	2.01	1.26	-95.68	-10.97	0.28	-85.36	0.42	23.42	4.74	
14.25	0.63	16.07	1.69	1.22	-98.80	-11.07	0.28	-87.94	0.42	23.34	4.59	
14.50	0.62	13.21	1.55	1.19	-102.38	-11.01	0.28	-91.06	0.43	16.21	4.31	
14.75	0.63	7.20	1.31	1.16	-106.51	-11.06	0.28	-94.60	0.43	14.91	4.15	
15.00	0.64	5.88	1.09	1.13	-109.67	-11.08	0.28	-97.33	0.44	7.07	3.93	
15.25	0.64	0.36	0.90	1.11	-113.27	-11.08	0.28	-100.46	0.44	7.37	3.74	
15.50	0.65	-2.83	0.65	1.08	-117.28	-11.16	0.28	-103.99	0.46	-0.85	3.59	
15.75	0.65	-6.30	0.47	1.06	-119.82	-11.16	0.28	-106.04	0.45	0.57	3.40	
16.00	0.66	-11.26	0.22	1.03	-124.36	-11.24	0.27	-110.14	0.48	-7.62	3.25	
16.25	0.66	-13.34	0.01	1.00	-126.60	-11.28	0.27	-111.95	0.48	-6.74	3.12	
16.50	0.67	-18.02	-0.23	0.97	-130.89	-11.36	0.27	-115.77	0.50	-15.01	2.87	
16.75	0.68	-21.20	-0.46	0.95	-133.60	-11.41	0.27	-118.00	0.50	-14.04	2.87	
17.00	0.68	-23.62	-0.68	0.92	-136.79	-11.48	0.27	-120.86	0.51	-20.85	2.60	
17.25	0.69	-27.89	-0.88	0.90	-140.08	-11.53	0.27	-123.77	0.52	-20.39	2.62	
17.50	0.70	-29.53	-1.15	0.88	-143.03	-11.65	0.26	-126.31	0.54	-26.79	2.41	
17.75	0.70	-33.36	-1.28	0.86	-145.91	-11.64	0.26	-128.74	0.54	-25.63	2.40	
18.00	0.72	-35.44	-1.59	0.83	-149.02	-11.78	0.26	-131.46	0.56	-31.88	2.23	

S-Parameter Data Files are available on-line at: www.mimixbroadband.com

CFS0303-SB Typical Noise Parameters

($V_{ds} = +3.0V, I_{ds} = 40 \text{ mA}$)

Freq. GHz	NFmin db	Gamma Mag.	Opt Ang.	Rn	Ga db
1.0	0.20	0.71	41.49	13.71	21.57
2.0	0.27	0.49	50.53	5.32	15.88
3.0	0.35	0.41	74.71	5.12	13.18
4.0	0.43	0.35	121.27	3.76	11.90
5.0	0.50	0.31	155.31	3.01	10.76
6.0	0.58	0.34	-174.66	2.36	9.37
7.0	0.65	0.35	-145.95	3.09	8.48
8.0	0.73	0.34	-118.50	5.73	7.66
9.0	0.81	0.39	-104.83	7.06	7.18
10.0	0.88	0.43	-88.18	9.40	6.46

MSG.MAG and $|S_{21}|^2$ vs. Frequency at 3V, 40mA

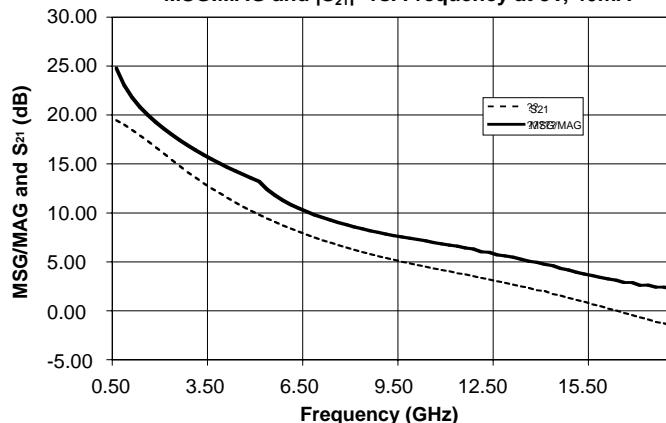

0.1-10.0 GHz Low Noise, Medium Power pHEMT in a Surface Mount Plastic Package



May 2006 - Rev 23-May-06

CFS0303-SB
 RoHS

Typical Scattering Parameters (V_{ds} = +3.0V, I_{ds} = 60 mA)

Frequency (GHz)	S11			S21			S12			S22		MSG/MAG (dB)
	(Mag)	(Ang)	(dB)	(Mag)	(Ang)	(dB)	(Mag)	(Ang)	(Mag)	(Ang)		
0.50	0.94	-35.04	20.41	10.48	155.01	-30.75	0.03	72.43	0.18	-51.69	25.58	
0.75	0.89	-51.29	19.92	9.91	143.36	-27.73	0.04	65.54	0.18	-72.92	23.82	
1.00	0.83	-66.27	19.30	9.22	132.46	-25.77	0.05	59.70	0.18	-91.24	22.53	
1.25	0.78	-80.10	18.64	8.55	122.73	-24.37	0.06	54.77	0.19	-107.99	21.50	
1.50	0.73	-92.87	18.00	7.94	113.70	-23.33	0.07	50.56	0.19	-121.39	20.66	
1.75	0.69	-104.22	17.31	7.34	105.71	-22.47	0.08	46.99	0.20	-133.38	19.89	
2.00	0.65	-115.12	16.64	6.79	98.17	-21.77	0.08	43.76	0.20	-143.81	19.20	
2.25	0.63	-124.76	15.96	6.28	91.58	-21.14	0.09	40.95	0.21	-152.75	18.55	
2.50	0.60	-134.20	15.30	5.82	85.35	-20.59	0.09	38.23	0.21	-161.30	17.94	
2.75	0.58	-142.91	14.66	5.41	79.66	-20.09	0.10	35.71	0.22	-169.09	17.37	
3.00	0.57	-150.92	14.07	5.05	74.29	-19.62	0.10	33.35	0.22	-175.70	16.84	
3.25	0.55	-159.06	13.49	4.73	69.00	-19.20	0.11	30.90	0.23	177.04	16.35	
3.50	0.54	-166.05	12.95	4.44	64.19	-18.79	0.11	28.73	0.23	171.96	15.87	
3.75	0.54	-173.12	12.45	4.19	59.32	-18.40	0.12	26.40	0.24	165.50	15.43	
4.00	0.53	-179.74	11.95	3.96	54.78	-18.05	0.13	24.14	0.24	161.19	15.00	
4.25	0.53	174.29	11.49	3.75	50.49	-17.69	0.13	21.94	0.25	155.77	14.59	
4.50	0.52	167.83	11.03	3.56	46.10	-17.36	0.14	19.58	0.26	151.49	14.20	
4.75	0.52	162.60	10.61	3.39	42.08	-17.04	0.14	17.39	0.26	146.86	13.82	
5.00	0.52	156.67	10.21	3.24	37.91	-16.73	0.15	15.07	0.27	142.79	12.91	
5.25	0.52	151.66	9.81	3.09	34.04	-16.45	0.15	12.83	0.27	138.60	12.24	
5.50	0.52	146.57	9.46	2.97	30.05	-16.16	0.16	10.49	0.28	134.83	11.79	
5.75	0.53	141.55	9.10	2.85	26.11	-15.90	0.16	8.18	0.28	130.78	11.34	
6.00	0.53	137.10	8.77	2.75	22.39	-15.64	0.17	5.89	0.29	127.86	10.95	
6.25	0.53	132.22	8.46	2.65	18.61	-15.38	0.17	3.53	0.29	123.88	10.59	
6.50	0.53	128.04	8.15	2.55	14.95	-15.14	0.17	1.13	0.30	120.87	10.27	
6.75	0.53	123.75	7.87	2.47	11.27	-14.89	0.18	-1.26	0.30	117.26	9.96	
7.00	0.54	119.54	7.57	2.39	7.64	-14.68	0.18	-3.68	0.31	114.37	9.69	
7.25	0.54	115.88	7.32	2.32	4.00	-14.43	0.19	-6.15	0.31	111.00	9.42	
7.50	0.55	111.54	7.05	2.25	0.37	-14.23	0.19	-8.62	0.32	108.06	9.18	
7.75	0.55	108.13	6.82	2.19	-3.24	-14.01	0.20	-11.11	0.31	105.05	8.96	
8.00	0.55	104.17	6.58	2.13	-6.77	-13.82	0.20	-13.63	0.33	101.77	8.73	
8.25	0.55	100.54	6.35	2.08	-10.31	-13.62	0.21	-16.21	0.32	99.65	8.55	
8.50	0.56	97.14	6.15	2.03	-13.71	-13.41	0.21	-18.70	0.33	96.29	8.34	
8.75	0.56	93.16	5.94	1.98	-17.40	-13.23	0.22	-21.50	0.33	94.12	8.19	
9.00	0.56	90.01	5.74	1.94	-20.84	-13.04	0.22	-24.05	0.34	90.65	8.01	
9.25	0.56	86.25	5.55	1.90	-24.50	-12.86	0.23	-26.82	0.34	88.14	7.86	
9.50	0.57	83.11	5.36	1.85	-27.95	-12.70	0.23	-29.39	0.35	84.81	7.71	
9.75	0.57	79.72	5.20	1.82	-31.75	-12.51	0.24	-32.34	0.34	82.37	7.59	
10.00	0.57	76.20	5.00	1.78	-35.09	-12.38	0.24	-34.86	0.35	79.16	7.44	
10.25	0.57	73.08	4.85	1.75	-38.88	-12.21	0.25	-37.89	0.35	77.16	7.31	
10.50	0.58	69.37	4.67	1.71	-42.41	-12.08	0.25	-40.69	0.36	72.88	7.13	
10.75	0.58	66.31	4.50	1.68	-45.97	-11.94	0.25	-43.57	0.35	71.42	7.02	
11.00	0.58	62.69	4.37	1.65	-49.70	-11.77	0.26	-46.64	0.36	66.63	6.87	
11.25	0.58	59.54	4.16	1.61	-53.33	-11.70	0.26	-49.61	0.35	65.77	6.77	
11.50	0.58	56.01	4.06	1.60	-56.97	-11.53	0.27	-52.58	0.37	60.32	6.58	
11.75	0.59	52.17	3.85	1.56	-60.80	-11.47	0.27	-55.73	0.37	58.46	6.47	
12.00	0.58	49.22	3.69	1.53	-64.24	-11.37	0.27	-58.57	0.37	53.28	6.20	
12.25	0.59	44.71	3.52	1.50	-68.28	-11.28	0.27	-62.00	0.37	51.67	6.14	
12.50	0.59	42.10	3.33	1.47	-71.65	-11.22	0.27	-64.76	0.38	45.81	5.90	
12.75	0.59	37.48	3.19	1.44	-75.69	-11.12	0.28	-68.24	0.38	44.98	5.80	
13.00	0.60	34.32	3.00	1.41	-79.29	-11.08	0.28	-71.26	0.40	38.49	5.64	
13.25	0.60	30.95	2.82	1.38	-82.81	-11.03	0.28	-74.21	0.39	37.47	5.44	
13.50	0.61	25.99	2.66	1.36	-86.79	-10.96	0.28	-77.65	0.41	30.93	5.26	
13.75	0.61	23.76	2.43	1.32	-89.95	-10.98	0.28	-80.35	0.39	30.36	5.16	

Continues Next Page. **S-Parameter Data Files are available on-line at: www.mimixbroadband.com**

Mimix Broadband, Inc., 10795 Rockley Rd., Houston, Texas 77099
 Tel: 281.988.4600 Fax: 281.988.4615 mimixbroadband.com

Page 12 of 17

Characteristic Data and Specifications are subject to change without notice. ©2006 Mimix Broadband, Inc.
 Export of this item may require appropriate export licensing from the U.S. Government. In purchasing these parts, U.S. Domestic customers accept their obligation to be compliant with U.S. Export Laws.

0.1-10.0 GHz Low Noise, Medium Power pHEMT in a Surface Mount Plastic Package



May 2006 - Rev 23-May-06

CFS0303-SB
RoHS

Typical Scattering Parameters (V_{ds} = +3.0V, I_{ds} = 60 mA) (cont.)

Frequency (GHz)	S11			S21			S12			S22		MSG/MAG (dB)
	(Mag)	(Ang)	(dB)	(Mag)	(Ang)	(dB)	(Mag)	(Ang)	(Mag)	(Ang)		
14.00	0.61	19.00	2.34	1.31	-94.40	-10.86	0.29	-84.28	0.42	22.09	4.96	
14.25	0.62	15.58	2.03	1.26	-97.49	-10.95	0.28	-86.85	0.42	22.10	4.79	
14.50	0.62	12.68	1.89	1.24	-101.07	-10.89	0.29	-89.99	0.43	14.80	4.54	
14.75	0.63	6.84	1.65	1.21	-105.14	-10.94	0.28	-93.58	0.43	13.77	4.37	
15.00	0.63	5.41	1.44	1.18	-108.31	-10.97	0.28	-96.33	0.44	5.94	4.15	
15.25	0.63	-0.01	1.25	1.15	-111.84	-10.96	0.28	-99.44	0.44	6.38	3.97	
15.50	0.65	-3.15	1.00	1.12	-115.82	-11.04	0.28	-102.99	0.46	-1.82	3.82	
15.75	0.64	-6.53	0.82	1.10	-118.34	-11.04	0.28	-105.04	0.45	-0.47	3.64	
16.00	0.66	-11.51	0.57	1.07	-122.87	-11.11	0.28	-109.19	0.48	-8.59	3.48	
16.25	0.66	-13.62	0.38	1.04	-125.11	-11.16	0.28	-111.03	0.48	-7.69	3.37	
16.50	0.66	-18.13	0.14	1.02	-129.34	-11.23	0.27	-114.80	0.50	-15.87	3.13	
16.75	0.68	-21.39	-0.09	0.99	-132.05	-11.28	0.27	-117.09	0.50	-14.91	3.12	
17.00	0.68	-23.77	-0.30	0.97	-135.22	-11.35	0.27	-119.96	0.51	-21.71	2.85	
17.25	0.69	-28.11	-0.50	0.94	-138.52	-11.39	0.27	-122.88	0.52	-21.20	2.90	
17.50	0.70	-29.70	-0.76	0.92	-141.43	-11.52	0.27	-125.43	0.53	-27.59	2.68	
17.75	0.70	-33.64	-0.89	0.90	-144.36	-11.51	0.27	-127.92	0.54	-26.52	2.67	
18.00	0.71	-35.60	-1.18	0.87	-147.45	-11.63	0.26	-130.64	0.55	-32.77	2.52	

S-Parameter Data Files are available on-line at: www.mimixbroadband.com

CFS0303-SB Typical Noise Parameters (V_{ds} = +3.0V, I_{ds} = 60 mA)

Freq. GHz	NFmin db	Gamma Opt		Rn	Ga db
		Mag.	Ang.		
1.0	0.19	0.73	37.02	10.82	21.05
2.0	0.26	0.56	50.99	5.04	15.81
3.0	0.34	0.36	84.39	5.60	14.08
4.0	0.41	0.31	124.27	3.63	12.33
5.0	0.49	0.30	160.12	2.90	11.17
6.0	0.56	0.34	-169.10	2.40	9.75
7.0	0.64	0.36	-140.08	3.55	8.84
8.0	0.71	0.33	-114.70	6.00	7.97
9.0	0.78	0.47	-102.15	7.49	7.47
10.0	0.86	0.43	-83.89	9.19	6.76

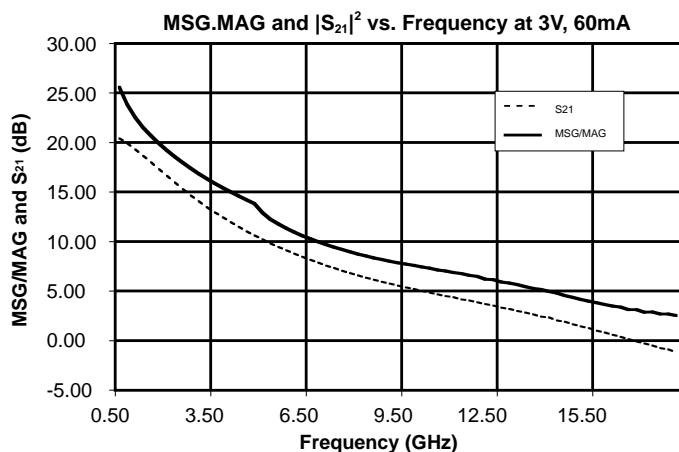

Mimix Broadband, Inc., 10795 Rockley Rd., Houston, Texas 77099
Tel: 281.988.4600 Fax: 281.988.4615 mimixbroadband.com

Page 13 of 17

Characteristic Data and Specifications are subject to change without notice. ©2006 Mimix Broadband, Inc.
Export of this item may require appropriate export licensing from the U.S. Government. In purchasing these parts, U.S. Domestic customers accept their obligation to be compliant with U.S. Export Laws.

0.1-10.0 GHz Low Noise, Medium Power pHEMT in a Surface Mount Plastic Package



May 2006 - Rev 23-May-06

CFS0303-SB
XRoHS

Considerations When Designing for Optimum Noise Figure Using Noise Parameters

For any two-port network, the noise figure gives a measure of the amount of noise added to a signal transmitted through that network. In this data sheet we have given the NF_{min} and the corresponding optimum source resistance values for the device under various bias conditions. NF_{min} represents the true minimum noise figure when the device is presented with an impedance matching network that transforms the source impedance typically 50 ohms to that optimum noise matching impedance referred to as G_{opt}. All stability considerations still apply, of course. If the calculated Rollet stability factor (K) is less than 1, then the source and load reflection coefficients must be carefully chosen. For an accurate graphical depiction of the unstable regions, it is best to draw stability circles.

In practice the impedance that minimizes the noise figure is different from the impedance that minimizes the return loss. Matching techniques such as inductive feedback will be used to bring the noise match closer to this gain match. An additional inherent danger of this technique is the increased instability of the design at higher frequencies. As the frequency increases the source inductance will also increase, this increases the amount of feedback to the devices source up to an oscillation level. This issue can be reduced by carefully choosing the input and output matching topology so that the transducer gain is limited at the frequency of potential oscillation. Design of a high pass / low pass matching network on the input and output is one solution that addresses this problem. Careful simulation is essential using the wideband s-parameters provided and can only be achieved through careful modeling of all components utilized in the design, including:

1. Accurate high frequency models for all surface mount components used.
2. Accurate models of the board characteristics including loss tangents and metal thickness.
3. Use of Via holes and via pads instead of perfect grounds where used.

In any case if the reflection coefficient of the chosen matching network is other than G_{opt}, then the noise figure of the device will be greater than NF_{min}. The losses of the matching circuits are also non-zero and it must be considered that the noise figure of the completed amplifier is equal to the noise figure of the device plus the losses of the matching network preceding the device.

The losses of the matching networks are related to the Q of the components and associated printed circuit board loss. In general larger gate width devices will typically have a lower G_{opt} as compared to smaller gate width devices. Matching to higher impedance devices requires very hi-Q components in order to minimize circuit losses. The main reason for using smaller gate width devices is the trade-off of current consumption and optimum noise performance. The CFS0301 is a 600um gate width device has a minimum noise figure of 0.18 dB and a G_{opt} of 45+j109, making it significantly easier to match than competitive devices. Associated gain G_a is 19.3dB.

Device Non-Linear Model

Mimix develops its own non-linear model based on its own internal device characterization. The model is verified in different simulators and compared to the original data from which it was extracted.

0.1-10.0 GHz Low Noise, Medium Power pHEMT in a Surface Mount Plastic Package

Packaged Device Model - Optimized for 0.1 to 18.0 GHz

This model can be used as a design tool. Please refer to the measured data contained in this data sheet for further design verification. Mimix reserves the right to change these models without prior notice.

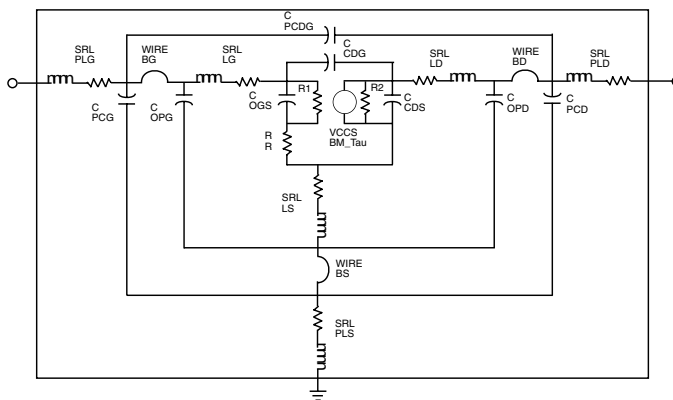

Typical Reflow Profiles

Reflow Profile	SnPb	Pb Free
Ramp Up Rate	3-4 °C/sec	3-4 °C/sec
Activation Time and Temperature	60-120 sec @ 140-160 °C	60-180 sec @ 170-200 °C
Time Above Melting Point	60-150 sec	60-150 sec
Max Peak Temperature	240 °C	265 °C
Time Within 5 °C of Peak	10-20 sec	10-20 sec
Ramp Down Rate	4-6 °C/sec	4-6 °C/sec

Die Model - Gate Width = 600 µm, Optimized for 0.1 GHz to 26.0 GHz

Cgs	1.04 pF	Rg	0.29	Cpd	0.08 pF
Cdg	0.07 pF	Ls	0.04 nH	PCG	0.195 pF
Cds	0.1 pF	Ld	0.1 nH	PCD	0.21 pF
Gm	303 mS	Lg	0.05 nH	PLS	0.085 nH
Ri	2.2 Ohm	BG	5 mil Gold wire (1 mil dia)	PLG	0.525 nH
Tau	0.06 ps	BD	5 mil Gold wire (1 mil dia)	PLD	0.55 nH
Rs	1.28	BS	3 mil Gold wire (1 mil dia)	PCDG	0.005 pF
Rd	1.35	Cpg	0.10 pF		

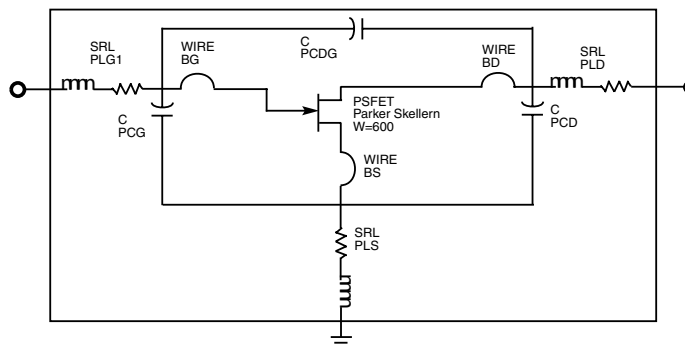

The PSFET is a Mimix implementation of the Parker Skellern large signal model. The model is available as an ADS project file on-line at: www.mimixbroadband.com

0.1-10.0 GHz Low Noise, Medium Power pHEMT in a Surface Mount Plastic Package

Physical Dimensions - SB Package (SOT-343)

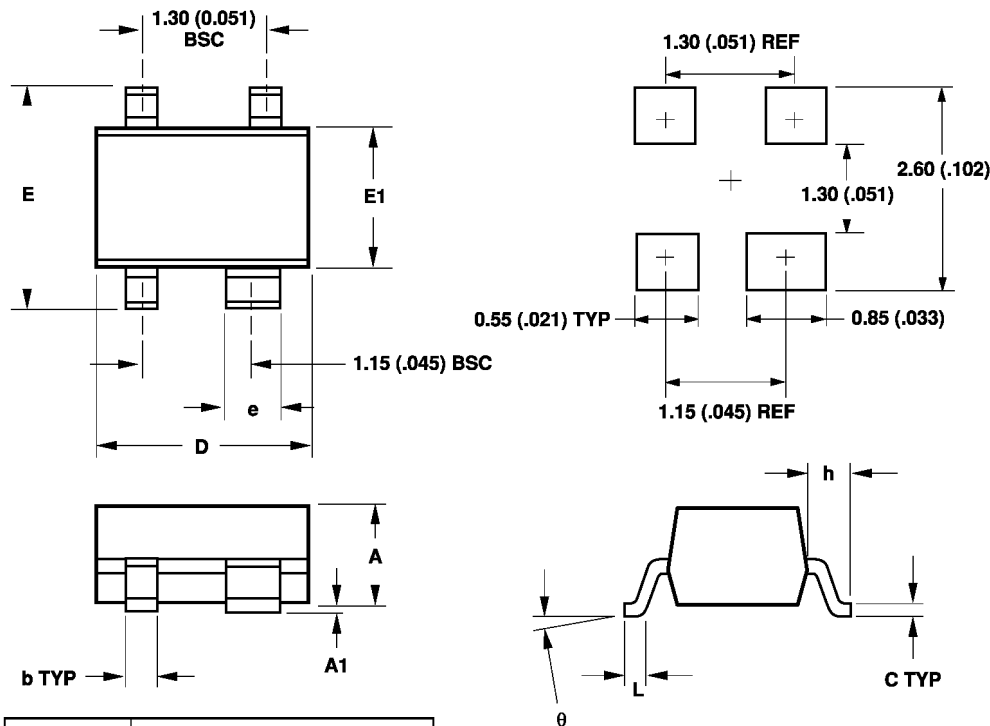

SYMBOL	DIMENSIONS	
	MIN.	MAX.
A	0.80 (0.031)	1.00 (0.039)
A1	0 (0)	0.10 (0.004)
b	0.25 (0.010)	0.35 (0.014)
C	0.10 (0.004)	0.20 (0.008)
D	1.90 (0.075)	2.10 (0.083)
E	2.00 (0.079)	2.20 (0.087)
e	0.55 (0.022)	0.65 (0.025)
h	0.450 TYP (0.018)	
E1	1.15 (0.045)	1.35 (0.053)
L	0.10 (0.004)	0.35 (0.014)
θ	0	10

DIMENSIONS ARE IN MILLIMETERS (INCHES)

Mimix reserves the right to make changes without further notice to any products herein. Mimix makes no warranty, representation or guarantee regarding the suitability of its products for any particular purpose, nor does Mimix assume any liability arising out of the application or use of any product or circuit, and specifically disclaims any and all liability, including without limitation consequential or incidental damages. "Typical" parameters can and do vary in different applications. All operating parameters, including "Typicals" must be validated for each customer application by customer's technical experts. Mimix does not convey any license under its patent rights nor the rights of others. Mimix products are not designed, intended, or authorized for use as components in systems intended for surgical implant into the body, or other applications intended to support or sustain life, or for any other application in which the failure of the Mimix product could create a situation where personal injury or death may occur. Should Buyer purchase or use Mimix products for any such unintended or unauthorized application, Buyer shall indemnify and hold Mimix and its officers, employees, subsidiaries, affiliates, and distributors harmless against all claims, costs, damages, and expenses, and reasonable attorney fees arising out of, directly or indirectly, any claim of personal injury or death associated with such unintended or unauthorized use, even if such claim alleges that Mimix was negligent regarding the design or manufacture of the part. Mimix Broadband is a registered trademark of Mimix Broadband, Inc. Mimix is an equal Opportunity/Affirmative Action Employer.

0.1-10.0 GHz Low Noise, Medium Power pHEMT in a Surface Mount Plastic Package



May 2006 - Rev 23-May-06

CFS0303-SB
XRoHS

Mimix Lead-Free RoHS Compliant Program - Mimix has an active program in place to meet customer and governmental requirements for eliminating lead (Pb) and other environmentally hazardous materials from our products. All Mimix RoHS compliant components are form, fit and functional replacements for their non-RoHS equivalents. Lead plating of our RoHS compliant parts is 100% matt tin (Sn) over copper alloy and is backwards compatible with current standard SnPb low-temperature reflow processes as well as higher temperature (260°C reflow) "Pb Free" processes.

Part Numbering Designator - For Mimix/Celeritek lead-free products, the letter "G" will be used in the part number for Matte Tin finished RoHS compliant components and "L" will be used in the part number of NiPdAu finished RoHS Compliant components in the second position of the part number suffix, as shown below:

Example A: CXX1234-XX-0G00 = component bulk quantity Matte Tin finished RoHS compliant parts

Example B: CXX1234-XX-0L0T = component in tape and reel NiPdAu finished RoHS parts

For those customers not making the change at this time, Mimix/Celeritek will maintain production of current configurations. For questions and comments e-mail: ourearth@mimixbroadband.com.



Ordering Information

Part Number for Ordering	Description
CFS0303-SB-0G00	Matte Tin plated RoHS compliant SOT-343 surface mount package in bulk quantity
CFS0303-SB-0G0T	Matte Tin plated RoHS compliant SOT-343 surface mount package in tape and reel
PB-CFS0303-SB-00A0	Evaluation Board for 900MHz with SMA connectors
PB-CFS0303-SB-00B0	Evaluation Board for 1900MHz with SMA connectors
PB-CFS0303-SB-00C0	Evaluation Board for 2400MHz with SMA connectors
PB-CFS0303-SB-00D0	Evaluation Board for 3500MHz with SMA connectors

We also offer the plastic packages with SnPb (Tin-Lead) or NiPdAu plating. Please contact your regional sales manager for more information regarding different plating types