PWM STEP-DOWN DC/DC CONVERTER WITH SYNCHRONOUS RECTIFIER

NO.EA-129-0606

OUTLINE

The R1232D Series are CMOS-based PWM step-down DC/DC converters with synchronous rectifier, low supply current. As an output capacitor, a 10 μ F or more ceramic capacitor can be used with the R1232D.

Each of these ICs consists of an oscillator, a PWM control circuit, a voltage reference unit, an error amplifier, a soft-start circuit, protection circuits, a protection against miss operation under low voltage (UVLO), a chip enable circuit, a synchronous rectifier, Nch. driver transistor, and so on. A low ripple, high efficiency step-down DC/DC converter can be easily composed of this IC with only a few kinds of external components, or an inductor and capacitors. (As for R1232D001x type, divider resistors are also necessary.) In terms of the output voltage, it is fixed internally in the R1232Dxx1x types. While in the R1232D001x types, the output voltage is adjustable with external divider resistors.

As protection circuits, current limit circuit which limits peak current of L_x at each clock cycle, and latch type protection circuit exist. The latch protection works if the term of the over-current condition keeps on a certain time. Latch-type protection circuit works to latch an internal driver with keeping it disable. To release the condition of protection, after disable this IC with a chip enable circuit, enable it again, or restart this IC with power-on or make the supply voltage at UVLO detector threshold level or lower than UVLO.

FEATURES

- Two choices of Oscillator Frequency 1MHz, 2.25MHz
(Small inductors can be used. 4.7 μ H for 1MHz/2.2 μ H for 2.25MHz)
- Built-in Driver ON Resistance P-channel 0.2 Ω (at V_{IN}=5.0V)
- Built-in Soft-start Function..... Typ. 1.0ms (fosc=1MHz type)
- Output Voltage 0.9V to 3.3V (xx1x Type)
0.8V to V_{IN} (001x Type)
- High Accuracy Output Voltage \pm 2.0%
- Built-in Current Limit Circuit Typ. 1.4A
- Package SON-8 (t=0.9mm)

APPLICATIONS

- Power source for portable equipment such as PDA, DSC, Notebook PC.
- Power source for HDD

BLOCK DIAGRAMS

R1232Dxx1A/B

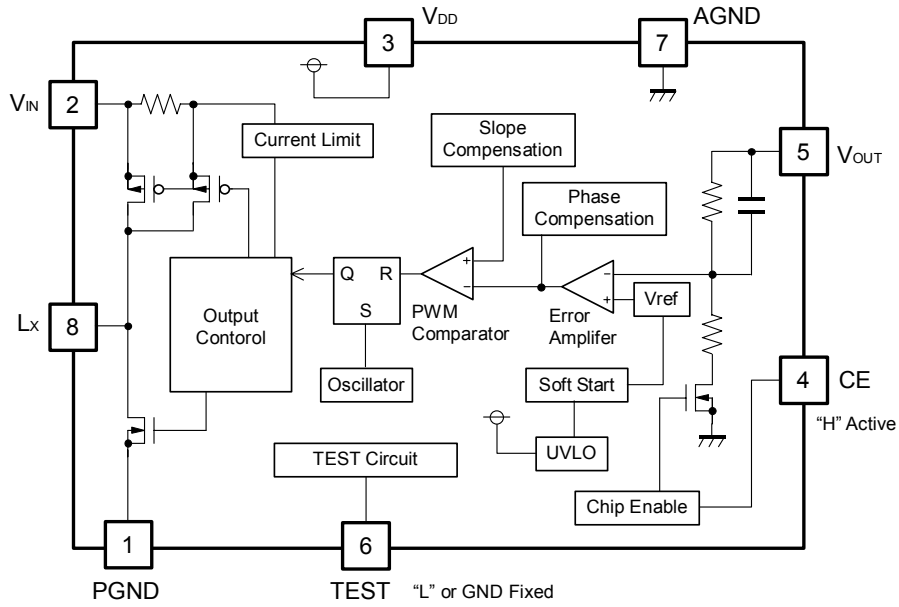

R1232D001C/D

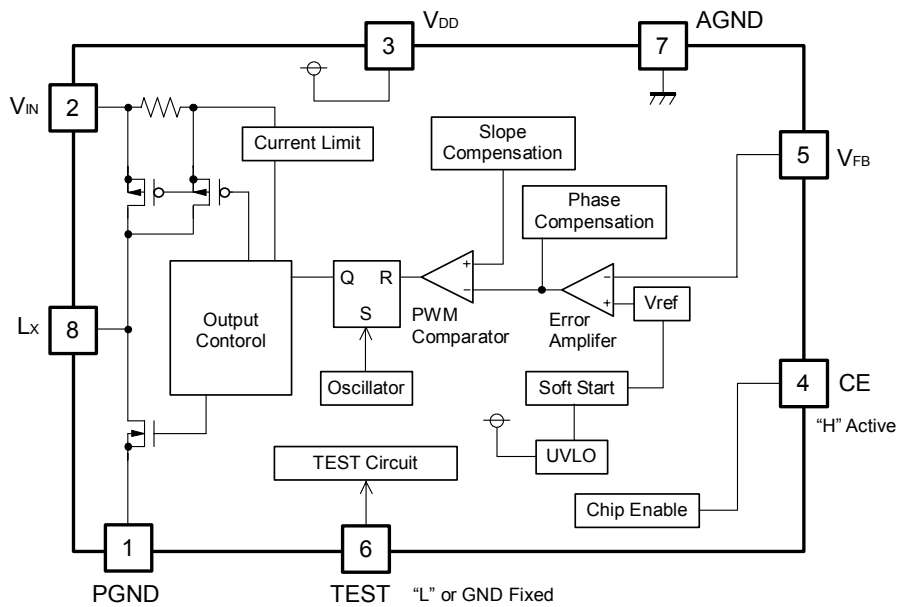

SELECTION GUIDE

In the R1232D Series, the output voltage, the oscillator frequency, and the taping type for the ICs can be selected at the user's request.

The selection can be made with designating the part number as shown below;

R1232D xx1x-xx-x ← Part Number
 ↑ ↑ ↑ ↑ ↑
 a bc d e

Code	Contents
a	Setting Output Voltage(V_{OUT}): Stepwise setting with a step of 0.1V in the range of 0.9V to 3.3V is possible for fixed output version."00" is for Output Voltage Adjustable version (0.8V as the feedback voltage.)
b	1: fixed
c	Designation of Optional Function A: 1MHz, Fixed Output Voltage B: 2.25MHz, Fixed Output Voltage C: 1MHz, Adjustable Output Voltage D: 2.25MHz, Adjustable Output Voltage
d	Designation of Taping Type; (Refer to Taping Specification)"TR" is prescribed as a standard.
e	Designation of Composition of pin plating -F : Lead free plating

PIN CONFIGURATION

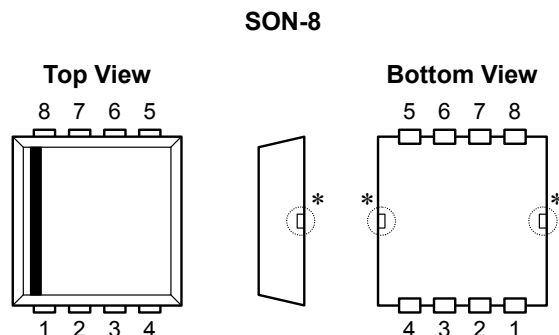

PIN DESCRIPTIONS

Pin No	Symbol	Pin Description
1	PGND	Ground Pin
2	V_{IN}	Voltage Supply Pin
3	V_{DD}	Voltage Supply Pin
4	CE	Chip Enable Pin (active with "H")
5	V_{OUT}/V_{FB}	Output/Feedback Pin
6	TEST	Test Pin (Forced to the "L" or GND level.)
7	AGND	Ground Pin
8	Lx	Lx Switching Pin (CMOS Output)

* Tab in the  parts have GND level. (They are connected to the reverse side of this IC.)
Do not connect to other wires or land patterns.

ABSOLUTE MAXIMUM RATINGS

Symbol	Item	Rating	Unit
V_{IN}	V_{IN} Supply Voltage	6.5	V
V_{DD}	V_{DD} Pin Voltage	6.5	V
V_{LX}	Lx Pin Voltage	-0.3 to $V_{IN} + 0.3$	V
V_{CE}	CE Pin Input Voltage	-0.3 to $V_{IN} + 0.3$	V
V_{TEST}	TEST Pin Input Voltage	-0.3 to $V_{IN} + 0.3$	V
V_{FB}	V_{FB} Pin Input Voltage	-0.3 to $V_{IN} + 0.3$	V
I_{LX}	Lx Pin Output Current	± 1.5	V
P_D	Power Dissipation (SON-8)*1	480	mW
T _{opt}	Operating Temperature Range	-40 to 85	°C
T _{stg}	Storage Temperature Range	-55 to 125	°C

*1) For the power dissipation, refer to the package information on the website.

ELECTRICAL CHARACTERISTICS

• R1232DxxxA/C

T_{opt}=25°C

Symbol	Item	Conditions	Min.	Typ.	Max.	Unit
V _{IN}	Operating Input Voltage		2.6		5.5	V
V _{OUT}	Step-down Output Voltage	V _{IN} =V _{CE} =5.0V, I _{OUT} =10mA	×0.980		×1.020	V
V _{FB}	Feedback Voltage	V _{IN} =V _{CE} =5.0V, I _{OUT} =10mA	0.784	0.800	0.816	V
ΔV _{OUT} /ΔT _{opt}	Step-down Output Voltage Temperature Coefficient	-40°C ≤ T _{opt} ≤ 85°C		±150		ppm/°C
f _{osc}	Oscillator Frequency	V _{IN} =V _{CE} =V _{SET} +1.5V	0.75	1.00	1.25	MHz
I _{DD}	Supply Current	V _{IN} =V _{CE} =5.5V, V _{OUT} =5.5V	70	140	190	μA
I _{standby}	Standby Current	V _{CE} =V _{OUT} =0V, V _{IN} =5.5V		0.0	5.0	μA
I _{Lxleak}	L _x Leakage Current	V _{IN} =5.5V, V _{CE} =0V V _{LX} =0V/5.5V	-5.0	0.0	5.0	μA
R _{ONP}	ON Resistance of Pch Transistor	V _{IN} =5.0V, I _{LX} =200mA		0.20	0.35	Ω
R _{ONN}	ON Resistance of Nch Transistor	V _{IN} =5.0V, I _{LX} =200mA		0.20	0.35	Ω
Maxduty	Oscillator Maximum Duty Cycle		100			%
t _{start}	Soft-start Time	V _{IN} =V _{CE} =5.0V, at no load	0.5	1.0	1.4	ms
t _{prot}	Protection Delay Time	V _{IN} =V _{CE} =5.0V	0.1	2.0	10.0	ms
I _{Lxlimit}	L _x Current Limit	V _{IN} =V _{CE} =5.0V	1.0	1.4		A
V _{UVLO1}	UVLO Detector Threshold	V _{IN} =V _{CE} =2.6V-> 1.5V	2.10	2.25	2.40	V
V _{UVLO2}	UVLO Released Voltage	V _{IN} =V _{CE} =1.5V-> 2.6V	2.20	V _{UVLO1} +0.10	2.50	V
I _{CE}	CE Input Current	V _{IN} =5.5V, V _{CE} =5.5V/0V	-0.1	0.0	0.1	μA
I _{VOUT}	V _{OUT} Leakage Current	V _{IN} =5.5V, V _{CE} =0V, V _{OUT} =5.5V/0V	-0.1	0.0	0.1	μA
V _{CEH}	CE "H" Input Voltage	V _{IN} =5.5V	1.5			V
V _{CEL}	CE "L" Input Voltage	V _{IN} =3.0V			0.3	V
V _{TESTL}	TEST pin "L" Input Voltage	V _{IN} =3.0V			0.3	V

R1232D

• R1232DxxxB/DT_{opt}=25°C

Symbol	Item	Conditions	Min.	Typ.	Max.	Unit
V _{IN}	Operating Input Voltage		2.6		5.5	V
V _{OUT}	Step-down Output Voltage	V _{IN} =V _{CE} =5.0V, I _{OUT} =10mA	×0.980		×1.020	V
V _{FB}	Feedback Voltage	V _{IN} =V _{CE} =5.0V, I _{OUT} =10mA	0.784	0.800	0.816	V
ΔV _{OUT} /ΔT _{opt}	Step-down Output Voltage Temperature Coefficient	-40°C ≤ T _{opt} ≤ 85°C		±150		ppm/°C
f _{osc}	Oscillator Frequency	V _{IN} =V _{CE} =V _{SET} +1.5V	1.91	2.25	2.58	MHz
I _{DD}	Supply Current	V _{IN} =V _{CE} =5.5V, V _{OUT} =5.5V	170	240	310	μA
I _{standby}	Standby Current	V _{CE} =V _{OUT} =0V, V _{IN} =5.5V		0.0	5.0	μA
I _{Lxleak}	L _x Leakage Current	V _{IN} =5.5V, V _{CE} =0V, V _{LX} =0V/5.5V	-5.0	0.0	5.0	μA
R _{ONP}	ON Resistance of Pch Transistor	V _{IN} =5.0V, I _{LX} =200mA		0.20	0.35	Ω
R _{ONN}	ON Resistance of Nch Transistor	V _{IN} =5.0V, I _{LX} =200mA		0.20	0.35	Ω
Maxduty	Oscillator Maximum Duty Cycle		100			%
t _{start}	Soft-start Time	V _{IN} =V _{CE} =5.0V, at no load	0.15	0.4	0.7	ms
t _{prot}	Protection Delay Time	V _{IN} =V _{CE} =5.0V	0.1	2.0	10.0	ms
I _{Lxlimit}	L _x Current Limit	V _{IN} =V _{CE} =5.0V	1.0	1.4		A
V _{UVLO1}	UVLO Detector Threshold	V _{IN} =V _{CE} =2.6V → 1.5V	2.10	2.25	2.40	V
V _{UVLO2}	UVLO Released Voltage	V _{IN} =V _{CE} =1.5V → 2.6V	2.20	V _{UVLO1} +0.10	2.50	V
I _{CE}	CE Input Current	V _{IN} =5.5V, V _{CE} =5.5V/0V	-0.1	0.0	0.1	μA
I _{VOUT}	V _{OUT} Leakage Current	V _{IN} =5.5V, V _{CE} =0V, V _{OUT} =5.5V/0V	-0.1	0.0	0.1	μA
V _{CEH}	CE "H" Input Voltage	V _{IN} =5.5V	1.5			V
V _{CEL}	CE "L" Input Voltage	V _{IN} =3.0V			0.3	V
V _{TESTL}	TEST "L" Input Voltage	V _{IN} =3.0V			0.3	V

TEST CIRCUIT

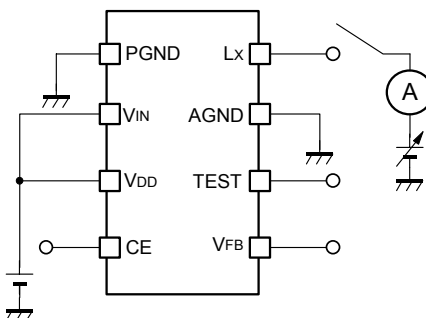

Test Circuit for Input Current and Leakage Current

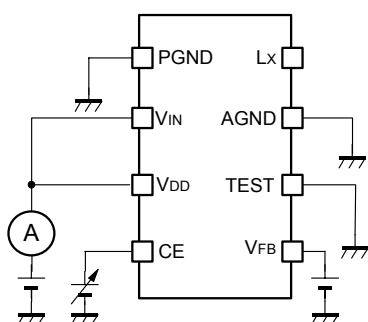

Test Circuit for Supply Current and Standby Current

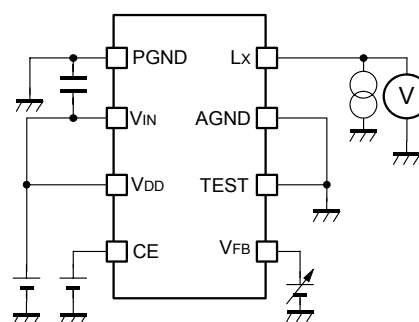

Test Circuit for ON resistance of Lx

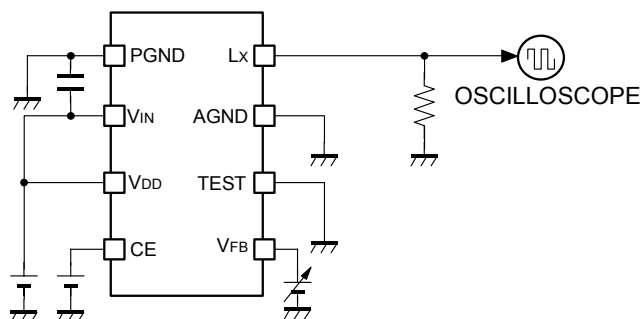

Input Voltage, Output Voltage, Frequency, Lx Current Limit, Protection Delay Time, UVLO Voltage Test Circuit

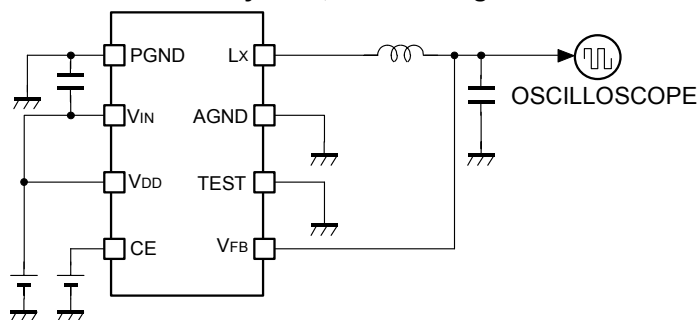

Soft Start Time Test Circuit

The bypass capacitor between power supply and GND is a ceramic capacitor 10 μ F.

TYPICAL APPLICATION AND TECHNICAL NOTES

• **Fixed Output Voltage Type**

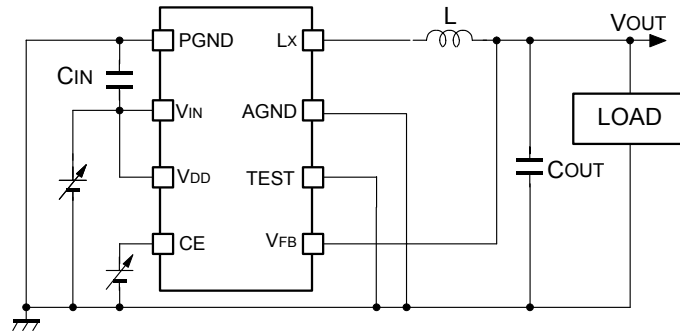

• **Adjustable Output Type**

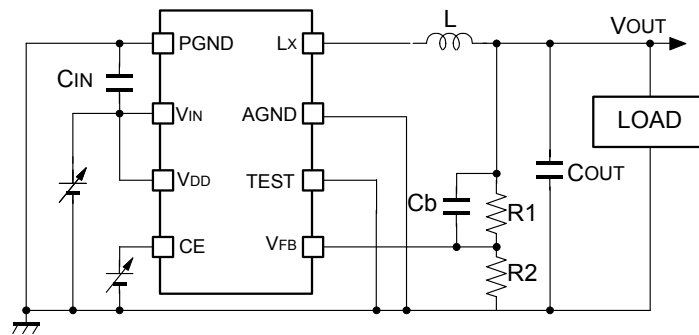

C _{IN}	10μF C2012JB0J106MT (TDK), 10μF CM21B106M06AB (Kyocera)
C _{OUT}	10μF C2012JB0J106MT (TDK), 10μF CM21B106M06AB (Kyocera)
L	4.7μH/2.7μH VLP5610-4R7MR90, VLP5610-2R7M1R0 (TDK) *2.2μH is also suitable for B version.

In terms of setting R1, R2, C_b, refer to the technical notes.

When you use these ICs, consider the following issues;

- Input the same voltage into power supply pins, V_{IN} and V_{DD} . Set the same level as AGND and PGND.
- When you control the CE pin by another power supply, do not make its "H" level more than the voltage level of V_{IN} / V_{DD} pin.
- Set external components such as an inductor, C_{IN} , C_{OUT} as close as possible to the IC, in particular, minimize the wiring to V_{IN} pin and PGND pin.
- At stand by mode, (CE="L"), the L_X output is Hi-Z, or both P-channel transistor and N-channel transistor of L_X pin turn off.
- In terms of the protection circuits, current limit for the peak current of each cycle of L_X , and the latch protection circuit, which works if the over-limit current flows continuously for a certain time exist. To release the protection, once make this IC into be standby mode with chip enable pin, or make the supply voltage be down to UVLO threshold level or less.
- Reinforce the V_{IN} , PGND, and V_{OUT} lines sufficiently. Large switching current may flow in these lines. If the impedance of V_{IN} and PGND lines is too large, the internal voltage level in this IC may shift caused by the switching current, and the operation might be unstable.
- Connect the TEST Pin to the "L" or GND level.

The performance of power source circuits using these ICs extremely depends upon the peripheral circuits. Pay attention in the selection of the peripheral circuits. In particular, design the peripheral circuits in a way that the values such as voltage, current, and power of each component, PCB patterns and the IC do not exceed their respected rated values.

OPERATION of step-down DC/DC converter and Output Current

The step-down DC/DC converter charges energy in the inductor when L_x transistor is ON, and discharges the energy from the inductor when L_x transistor is OFF and controls with less energy loss, so that a lower output voltage than the input voltage is obtained. The operation will be explained with reference to the following diagrams:

<Basic Circuits>

<Current through L>

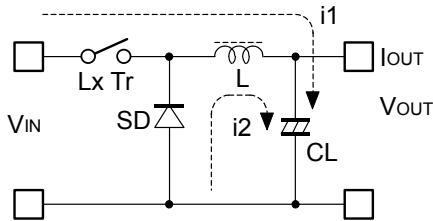

Step 1: P-channel Tr. turns on and current IL (=i1) flows, and energy is charged into CL. At this moment, IL increases from I_{lmin} (=0) to reach I_{lmax} in proportion to the on-time period (ton) of P-channel Tr.

Step 2: When P-channel Tr. turns off, Synchronous rectifier N-channel Tr. turns on in order that L maintains IL at I_{lmax}, and current IL (=i2) flows.

Step 3: IL (=i2) decreases gradually and reaches IL=I_{lmin}=0 after a time period of topen, and N-channel Tr. Turns off. Provided that in the continuous mode, next cycle starts before IL becomes to 0 because toff time is not enough. In this case, IL value increases from this I_{lmin} (>0).

In the case of PWM control system, the output voltage is maintained by controlling the on-time period (ton), with the oscillator frequency (fosc) being maintained constant.

• Continuous Conduction Mode

The maximum value (I_{lmax}) and the minimum value (I_{lmin}) of the current flowing through the inductor are the same as those when P-channel Tr. turns on and off.

The difference between I_{lmax} and I_{lmin}, which is represented by ΔI;

$$\Delta I = I_{lmax} - I_{lmin} = V_{OUT} \times t_{open} / L = (V_{IN} - V_{OUT}) \times t_{on} / L \dots \dots \dots \text{Equation 1}$$

Where, $t = 1 / f_{osc} = t_{on} + t_{off}$
 duty (%) = $t_{on} / t \times 100 = t_{on} \times f_{osc} \times 100$
 $t_{open} \leq t_{off}$

In Equation 1, $V_{OUT} \times t_{open} / L$ and $(V_{IN} - V_{OUT}) \times t_{on} / L$ are respectively shown the change of the current at ON, and the change of the current at OFF.

Even if the output current (I_{OUT}) is, $t_{open} < t_{off}$ as illustrated in the above diagram is not realized with this IC. At least, t_{open} is equal t_{off} ($t_{open} = t_{off}$), and when I_{OUT} is further increased, I_{lmin} becomes larger than zero (I_{lmin} > 0). The mode is referred to as the continuous mode.

In the continuous mode, when Equation 1 is solved for t_{on} and assumed that the solution is t_{onc}

$$t_{onc} = t \times V_{OUT} / V_{IN} \dots \dots \dots \text{Equation 2}$$

When the $t_{on} = t_{onc}$, the mode is the continuous mode.

OUTPUT CURRENT AND SELECTION OF EXTERNAL COMPONENTS

When P-channel Tr. of L_x is ON:

(Wherein, Ripple Current P-P value is described as I_{RP} , ON resistance of P-channel Tr. and N-channel Tr. of L_x are respectively described as R_{ONP} and R_{ONN} , and the DC resistor of the inductor is described as R_L .)

$$V_{IN} = V_{OUT} + (R_{ONP} + R_L) \times I_{OUT} + L \times I_{RP} / t_{on} \dots \dots \dots \text{Equation 3}$$

When P-channel Tr. of L_x is "OFF" (N-channel Tr. is "ON"):

$$L \times I_{RP} / t_{off} = V_F + V_{OUT} + R_{ONN} \times I_{OUT} \dots \dots \dots \text{Equation 4}$$

Put Equation 4 to Equation 3 and solve for ON duty of P-channel transistor, $D_{ON} = t_{on} / (t_{off} + t_{on})$,

$$D_{ON} = (V_{OUT} - R_{ONN} \times I_{OUT} + R_L \times I_{OUT}) / (V_{IN} + R_{ONN} \times I_{OUT} - R_{ONP} \times I_{OUT}) \dots \dots \dots \text{Equation 5}$$

Ripple Current is as follows;

$$I_{RP} = (V_{IN} - V_{OUT} - R_{ONP} \times I_{OUT} - R_L \times I_{OUT}) \times D_{ON} / f_{osc} / L \dots \dots \dots \text{Equation 6}$$

wherein, peak current that flows through L, and L_x Tr. is as follows;

$$I_{Lmax} = I_{OUT} + I_{RP} / 2 \dots \dots \dots \text{Equation 7}$$

Consider I_{Lmax} , condition of input and output and select external components.

★ The above explanation is directed to the calculation in an ideal case in continuous mode.

How to Adjust Output Voltage and about Phase Compensation

As for Adjustable Output type, feedback pin (V_{FB}) voltage is controlled to maintain 0.8V.
Output Voltage, V_{OUT} is as following equation;

$$V_{OUT} R1+R2=V_{FB}:R2$$
$$V_{OUT}=V_{FB}\times(R1+R2)/R2$$

Thus, with changing the value of R1 and R2, output voltage can be set in the specified range.

In the DC/DC converter, with the load current and external components such as L and C, phase might be behind 180 degree. In this case, the phase margin of the system will be less and stability will be worse. To prevent this, phase margin should be secured with proceeding the phase. A pole is formed with external components L and C_{OUT} .

$$f_{pole} \sim 1/2\pi\sqrt{LC_{OUT}}$$

A zero (signal back to zero) is formed with R1 and Cb.

$$f_{zero} \sim 1/(2\pi\times R1\times Cb)$$

First, choose the appropriate value of R1, R2 and Cb.
Set R1+R2 value 100k Ω or less.

For example, if L=4.7 μ H, C_{OUT} =10 μ F, the cut off frequency of the pole is approximately 23kHz.

To make the cut off frequency of the zero by R1, R2, and Cb be higher than 23kHz,
set R1=33k Ω and Cb=100pF. If V_{OUT} is set at 2.0V, R2=22k Ω is appropriate.

External Components

1. Inductor

Select an inductor that peak current does not exceed I_{Lmax} . If larger current than allowable current flows, magnetic saturation occurs and makes transform efficiency be worse.

Supposed that the load current is at the same, the smaller value of L is used, the larger the ripple current is.

Provided that the allowable current is large in that case and DC current is small, therefore, for large output current, efficiency is better than using an inductor with a large value of L and vice versa.

2. Capacitor

As for C_{IN} , use a capacitor with low ESR (Equivalent Series Resistance) Ceramic type of a capacity at least $10\mu F$ for stable operation.

C_{OUT} can reduce ripple of the output voltage, therefore as much as $10\mu F$ ceramic type is recommended.

TIMING CHART

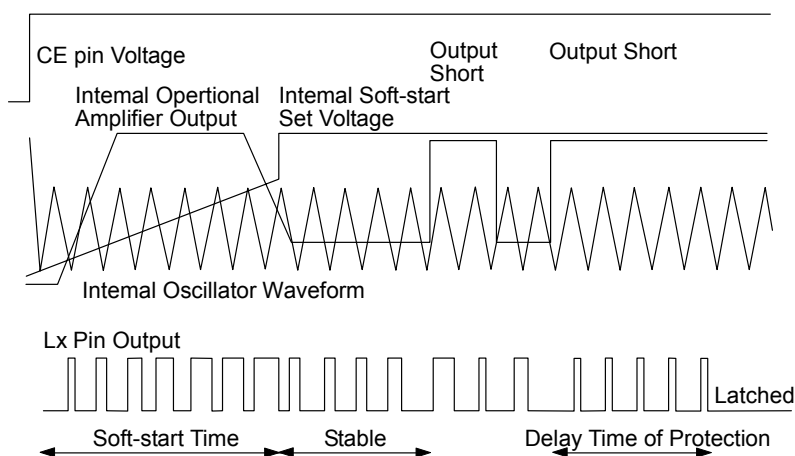

The timing chart as shown above describes the waveforms starting from the IC is enabled with CE and latched with protection. During the soft-start time, until the level is rising up to the internal soft-start set voltage, the duty cycle of L_x is gradually wider and wider to prevent the over-shoot of the voltage. During the term, the output of amplifier is "H". After the output voltage reaches the set output voltage, they are balanced well. Herein, if the output pin would be short circuit, the output of amplifier would become "H" again, and the condition would continue for 2.0ms (Typ.), latch circuit would work and the output of L_x would be latched with "OFF". (Output = "High-Z")

If the output short is released before the latch circuit works (within 2ms after output shorted), the output of amplifier is balanced in the stable state again.

Once the IC is latched, to release the protection, input "L" with CE pin, or make the supply voltage at UVLO level or less.

TYPICAL CHARACTERISTICS

1) Output Voltage vs. Output Current ($C_{IN} = 10\mu F$, $C_{OUT} = 10\mu F$)

R1232D121A

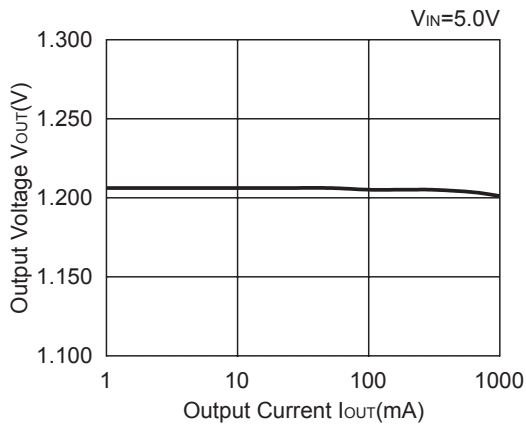

R1232D331A

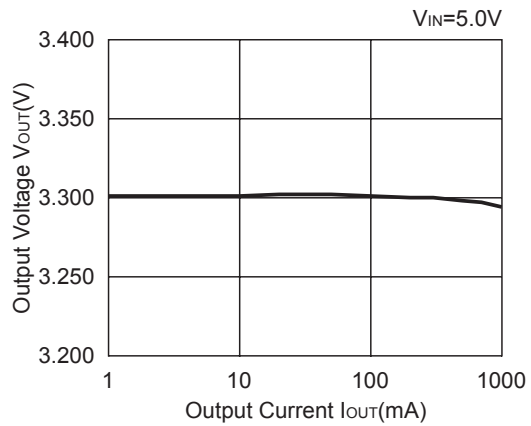

R1232D121B

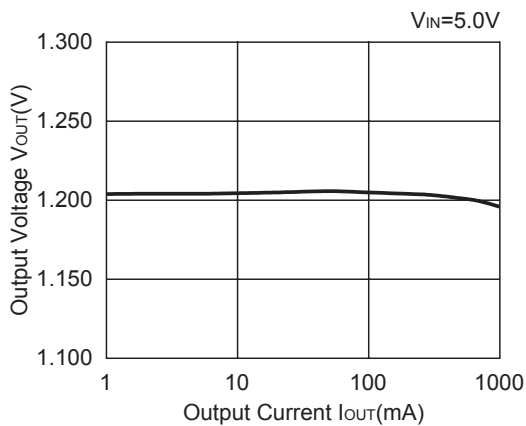

R1232D331B

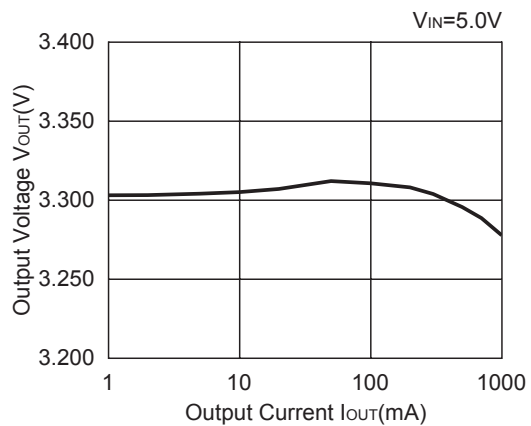

2) Efficiency vs. Output Current ($C_{IN} = 10\mu F$, $C_{OUT} = 10\mu F$)

R1232D121A

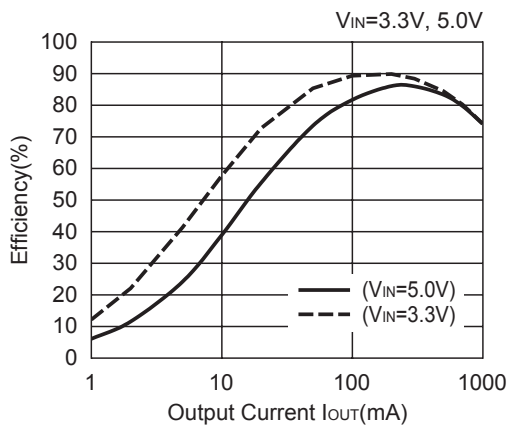

R1232D331A

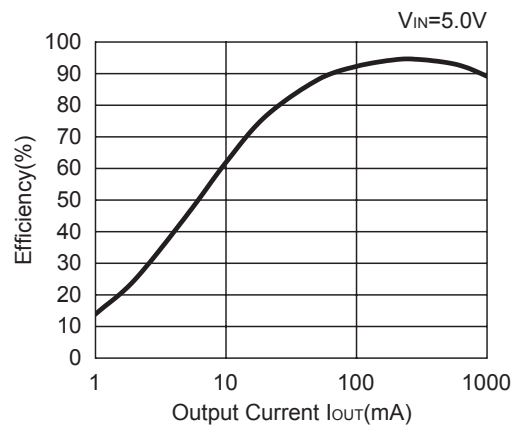

R1232D121B

R1232D331B

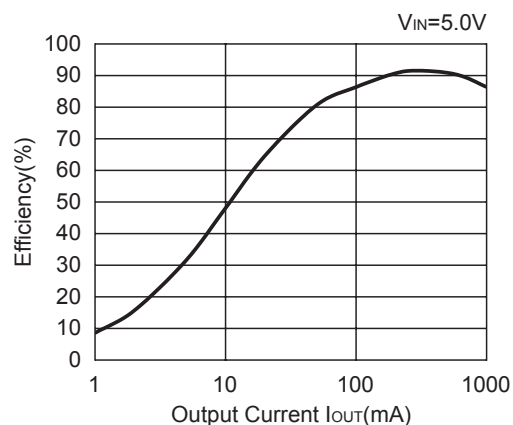
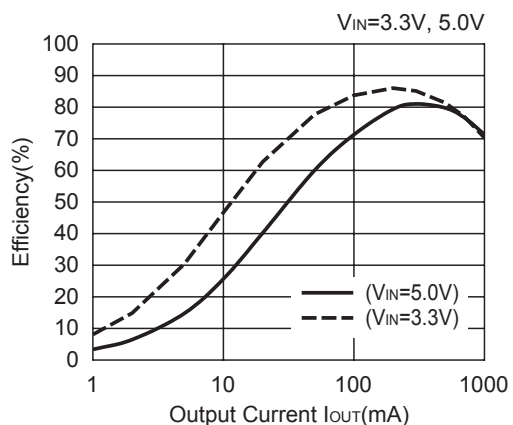

3) Output Waveform

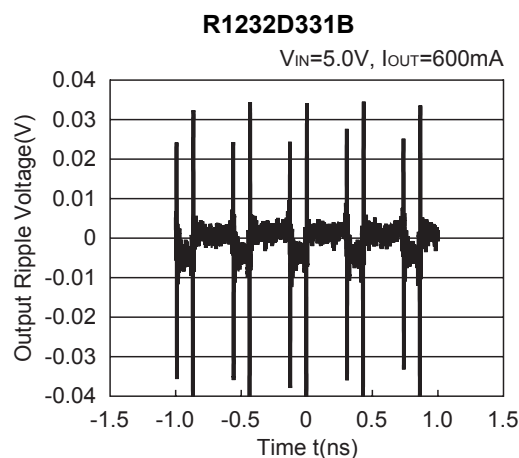
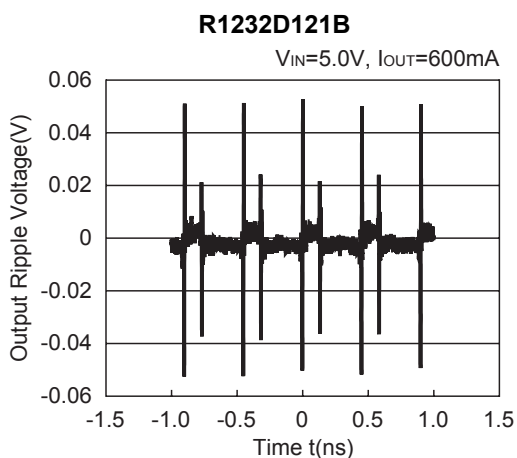
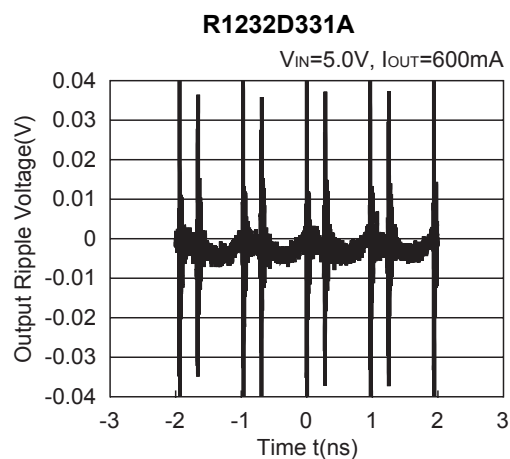
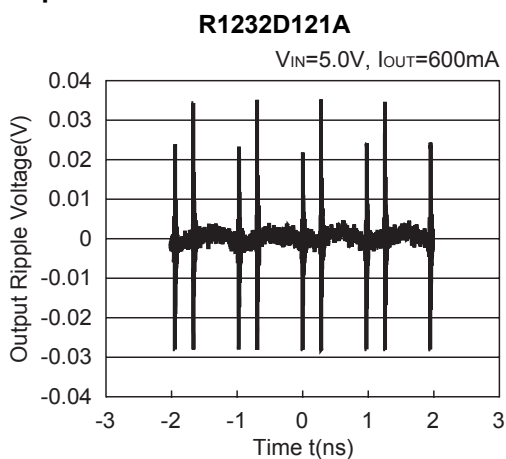

4) Load Transient Response

R1232D121A

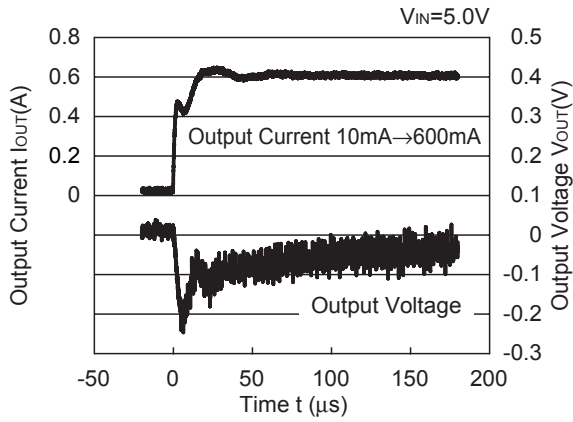

R1232D121A

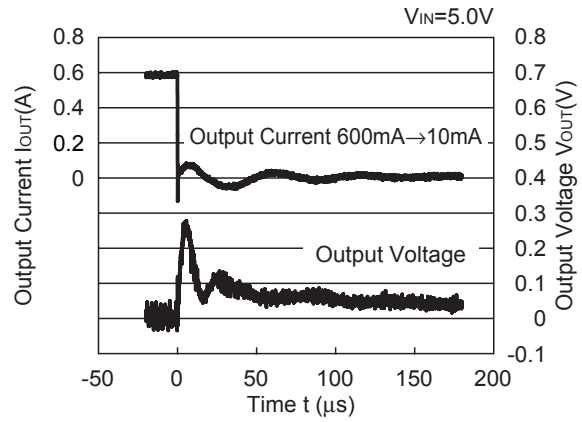

R1232D121B

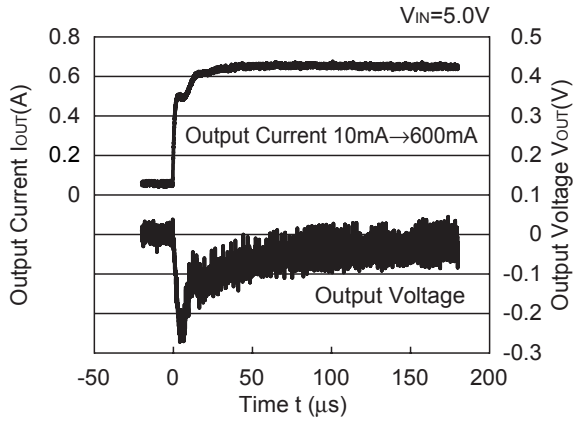

R1232D121B

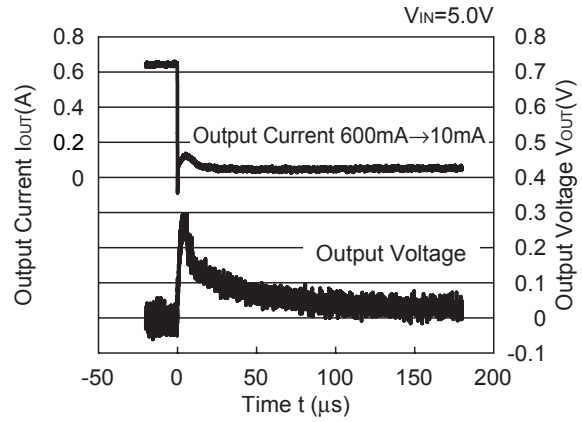

5) Output Voltage vs. Input Voltage

R1232D121A

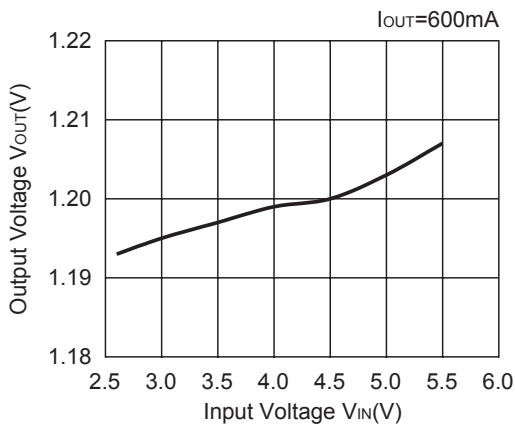

R1232D331A

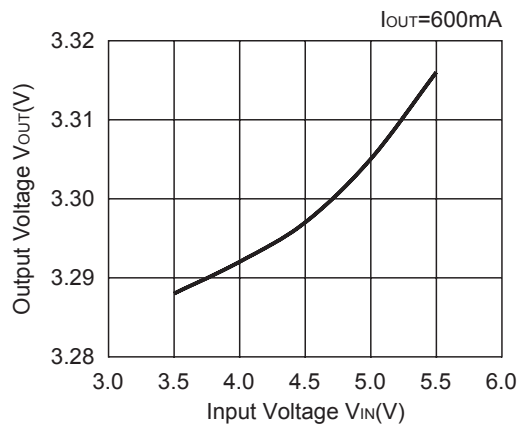

6) Oscillator Frequency vs. Input Voltage

R1232D121A

R1232D121B

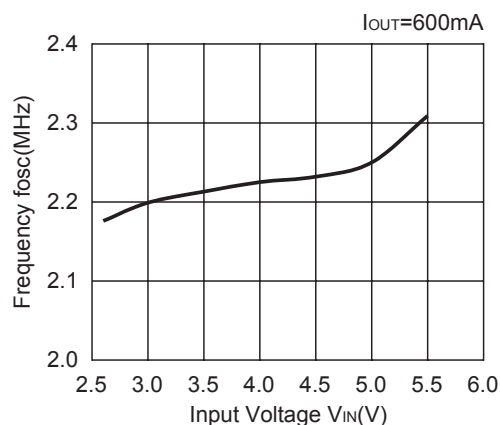
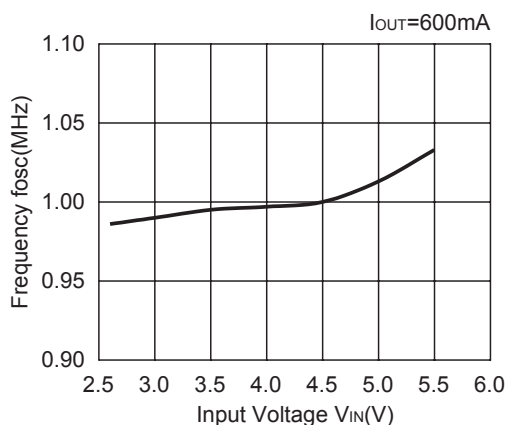

7) Lx Transistor On Resistance vs. Input Voltage
Switching Tr. Pch on Resistance

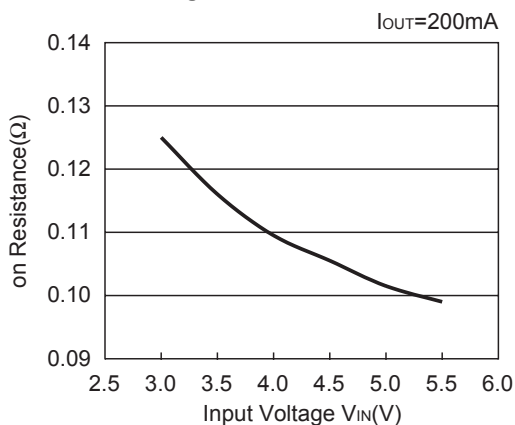

Synchronous Rectifier Tr. Nch on Resistance

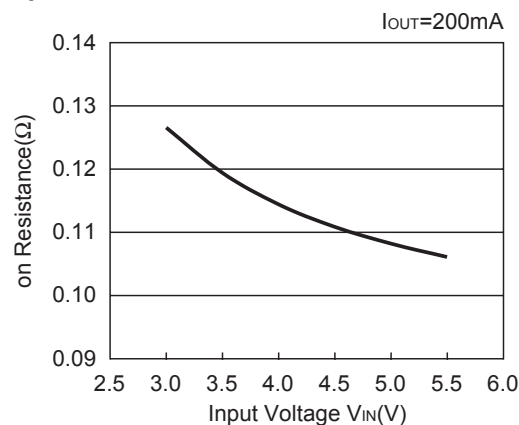

8) Turn-on speed by CE pin

R1232D121A

VIN=5.0V, L=4.7μH Rload=0Ω

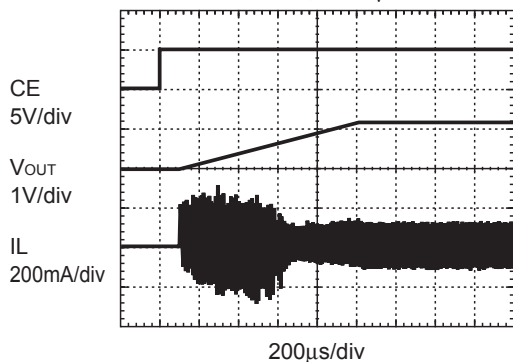

R1232D331B

R1232D121A

VIN=5.0V, L=4.7μH Rload=12Ω

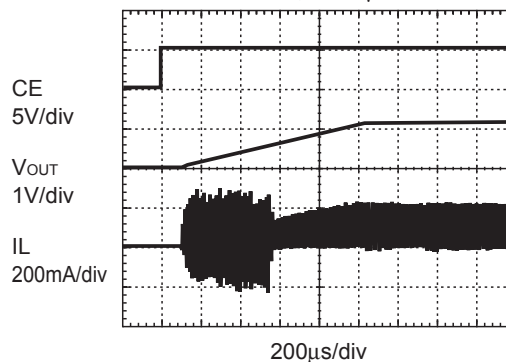

R1232D331B

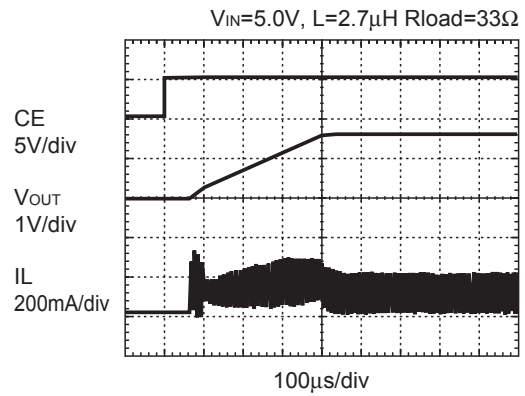
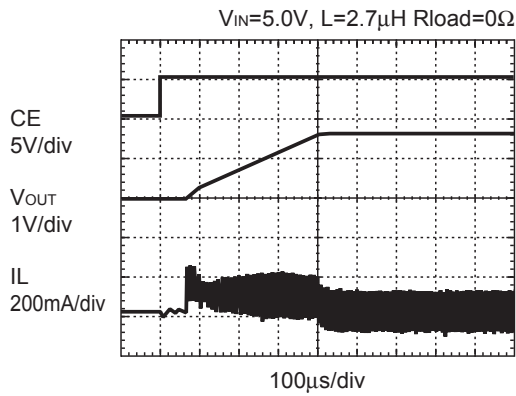

9) Output Voltage vs. Temperature

R1232D121A

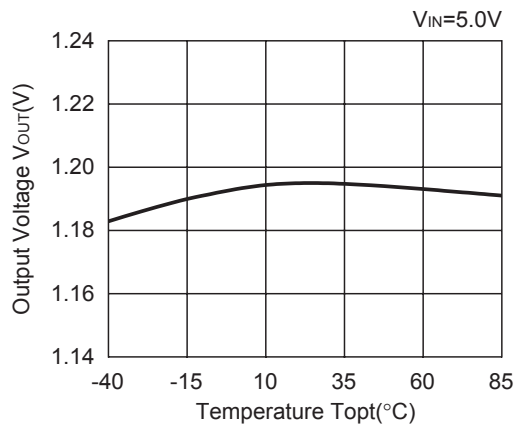

R1232D331A

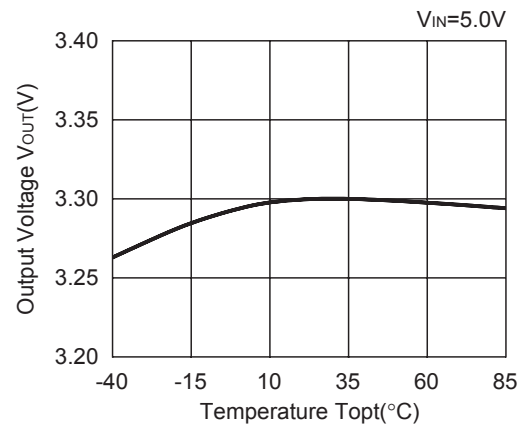

10) Oscillator Frequency vs. Temperature

R1232D121A

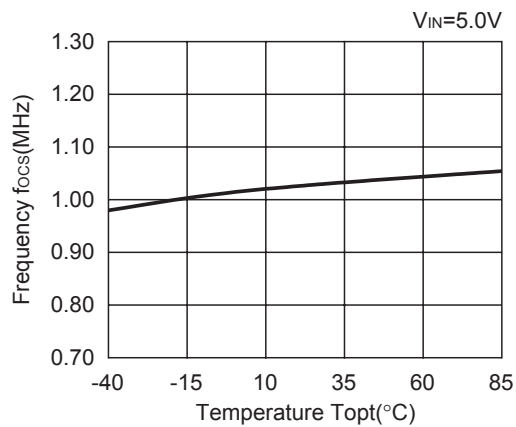

R1232D331B

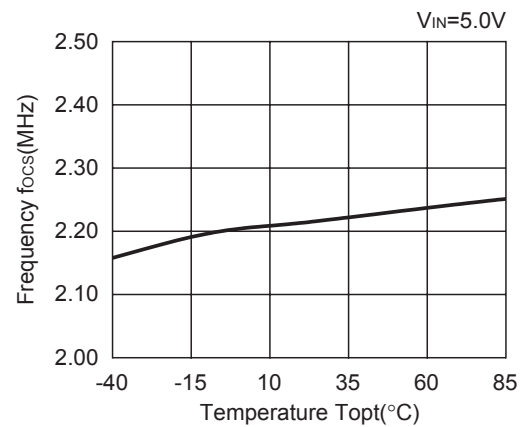

11) Supply Current vs. Temperature

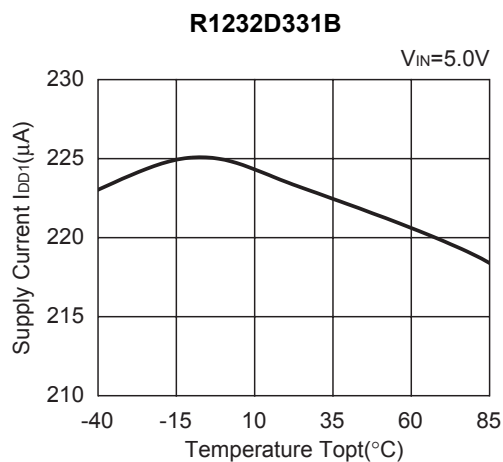
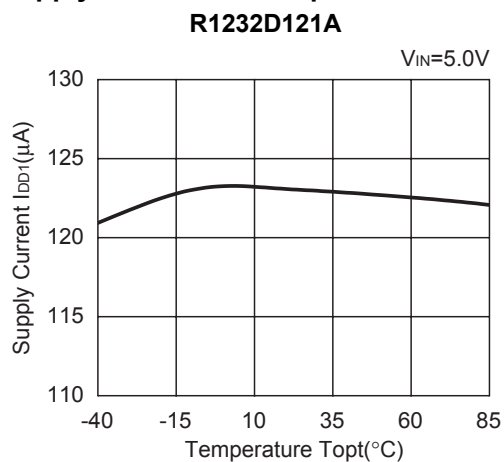

12) Soft-start time vs. Temperature

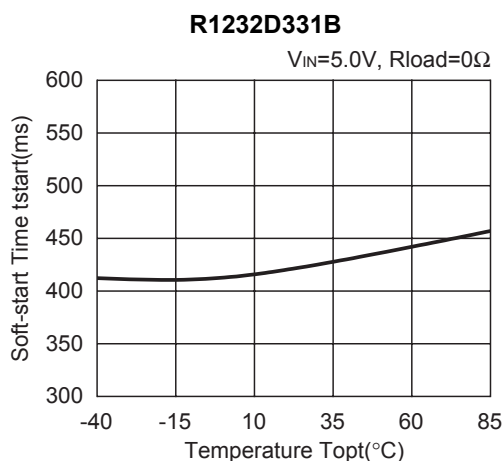
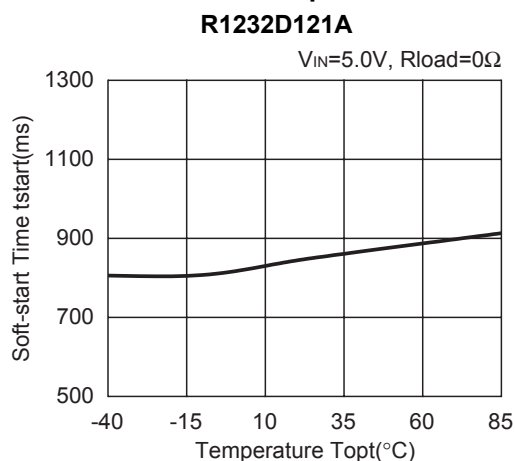

13) UVLO Voltage vs. Temperature

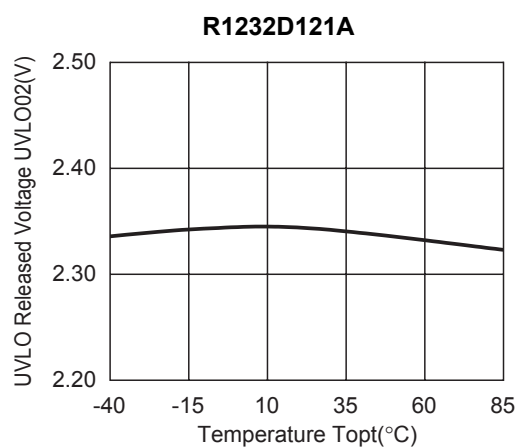
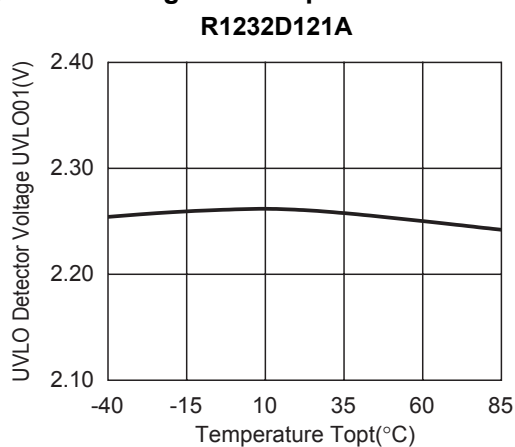

R1232D

14) CE Input Voltage vs. Temperature

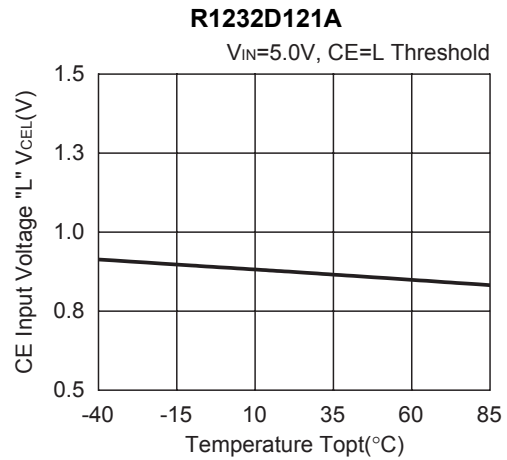
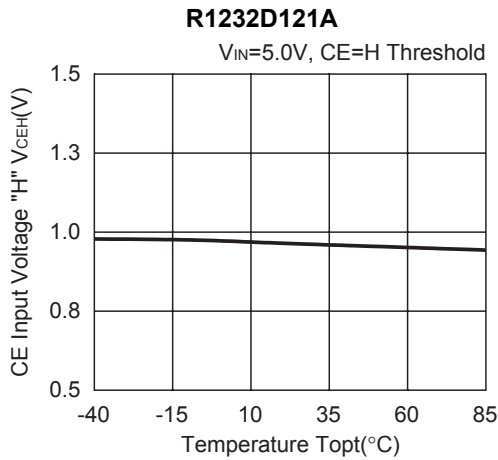

15) TEST Input Voltage vs. Temperature

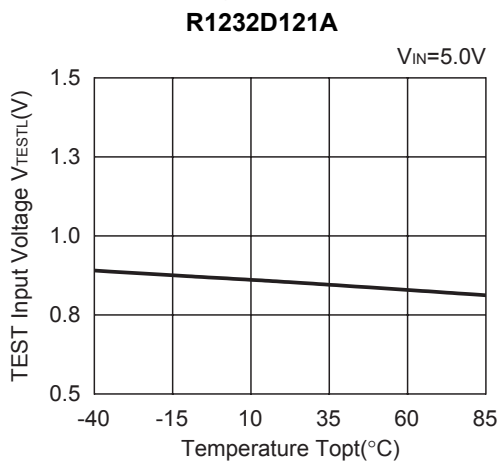

16) Lx Transistor On Resistance vs. Temperature

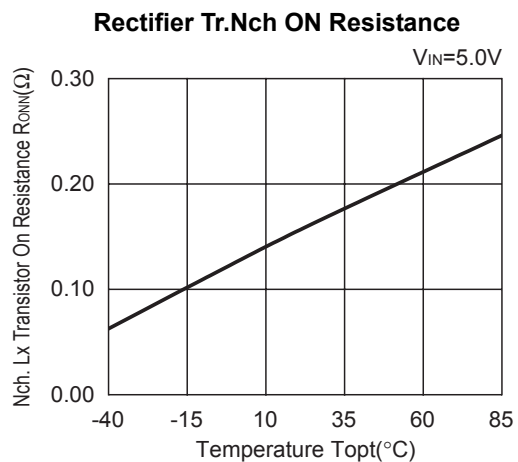
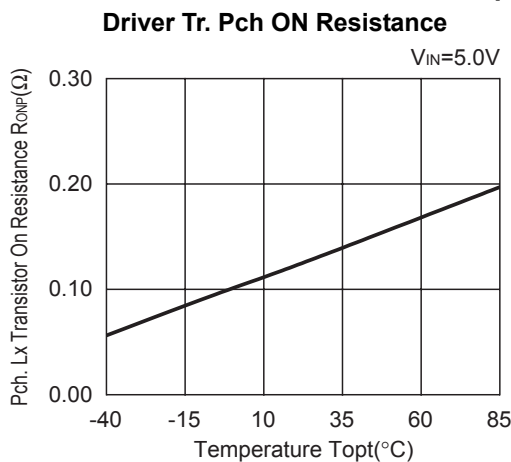

17) Current Limit vs. Temperature

R1232D121A

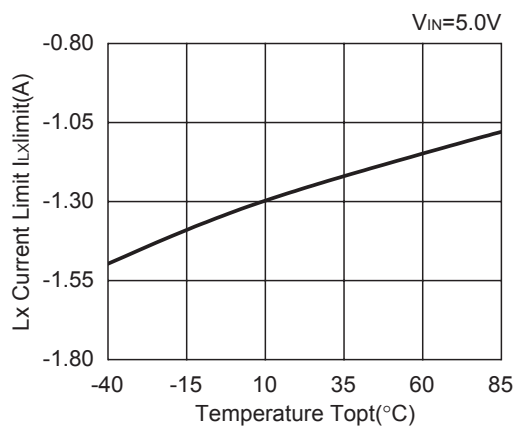

R1232D331B

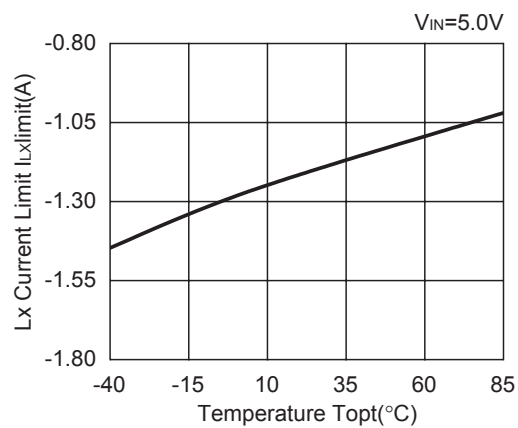

18) Protection Delay Time vs. Temperatures

R1232D121A

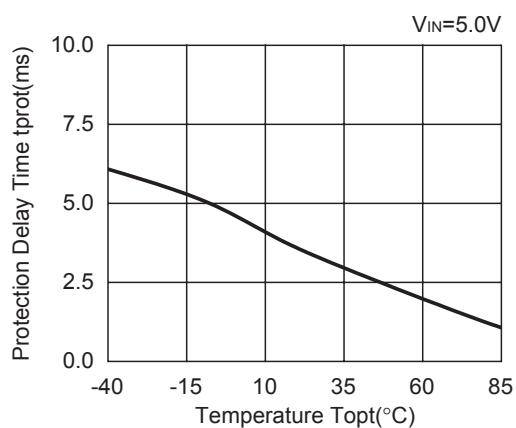

R1232D331B

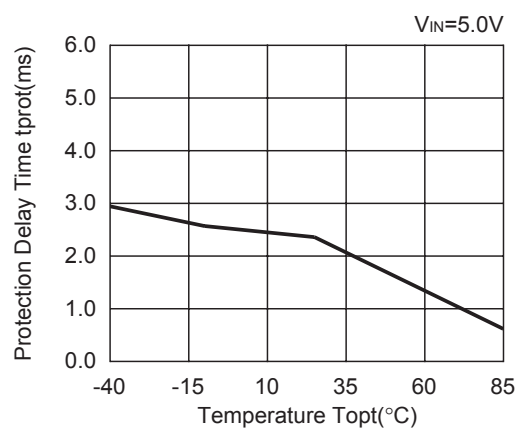

POWER DISSIPATION (SON-8)

This specification is at mounted on board. Power Dissipation (P_D) depends on conditions of mounting on board. This specification is based on the measurement at the condition below:

Measurement Conditions

	Standard Land Pattern
Environment	Mounting on Board (Wind velocity=0m/s)
Board Material	Glass cloth epoxy plactic (Double sided)
Board Dimensions	40mm × 40mm × 1.6mm
Copper Ratio	Top side : Approx. 50% , Back side : Approx. 50%
Through-hole	φ0.5mm × 44pcs

Measurement Result

($T_{opt}=25^{\circ}C, T_{jmax}=125^{\circ}C$)

	Standard Land Pattern	Free Air
Power Dissipation	480mW	300mW
Thermal Resistance	$\theta_{ja}=(125-25^{\circ}C)/0.48W=208^{\circ}C/W$	333 $^{\circ}C/W$

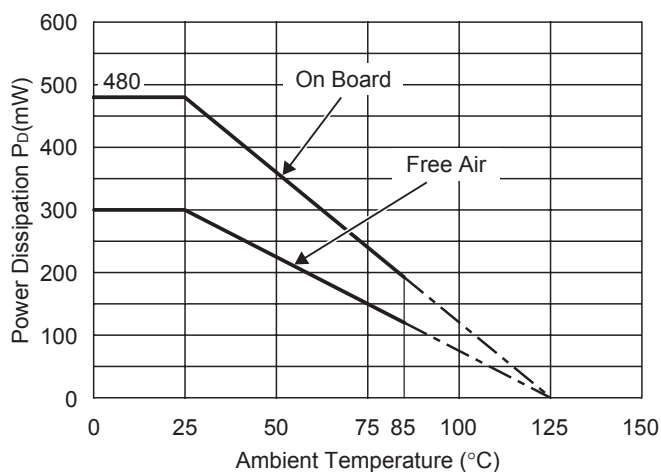

Power Dissipation

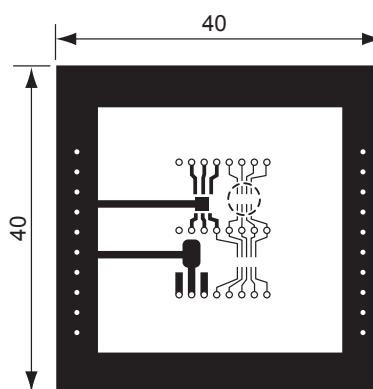

Measurement Board Pattern

○ IC Mount Area (Unit : mm)

RECOMMENDED LAND PATTERN

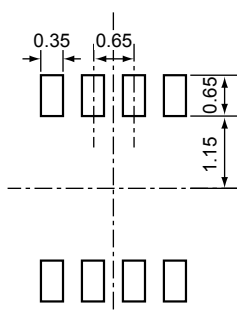

(Unit: mm)

R1232D SERIES MARK SPECIFICATION

● SON-8

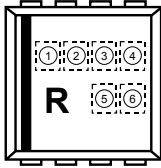

① to ④ : Product Code (refer to Part Number vs. Product Code)

⑤, ⑥ : Lot Number

● Part Number vs. Product Code

Part Number	Product Code			
	①	②	③	④
R1232D091A	K	0	9	A
R1232D101A	K	1	0	A
R1232D111A	K	1	1	A
R1232D121A	K	1	2	A
R1232D131A	K	1	3	A
R1232D141A	K	1	4	A
R1232D151A	K	1	5	A
R1232D161A	K	1	6	A
R1232D171A	K	1	7	A
R1232D181A	K	1	8	A
R1232D191A	K	1	9	A
R1232D201A	K	2	0	A
R1232D211A	K	2	1	A
R1232D221A	K	2	2	A
R1232D231A	K	2	3	A
R1232D241A	K	2	4	A
R1232D251A	K	2	5	A
R1232D261A	K	2	6	A
R1232D271A	K	2	7	A
R1232D281A	K	2	8	A
R1232D291A	K	2	9	A
R1232D301A	K	3	0	A
R1232D311A	K	3	1	A
R1232D321A	K	3	2	A
R1232D331A	K	3	3	A

Part Number	Product Code			
	①	②	③	④
R1232D091B	K	0	9	B
R1232D101B	K	1	0	B
R1232D111B	K	1	1	B
R1232D121B	K	1	2	B
R1232D131B	K	1	3	B
R1232D141B	K	1	4	B
R1232D151B	K	1	5	B
R1232D161B	K	1	6	B
R1232D171B	K	1	7	B
R1232D181B	K	1	8	B
R1232D191B	K	1	9	B
R1232D201B	K	2	0	B
R1232D211B	K	2	1	B
R1232D221B	K	2	2	B
R1232D231B	K	2	3	B
R1232D241B	K	2	4	B
R1232D251B	K	2	5	B
R1232D261B	K	2	6	B
R1232D271B	K	2	7	B
R1232D281B	K	2	8	B
R1232D291B	K	2	9	B
R1232D301B	K	3	0	B
R1232D311B	K	3	1	B
R1232D321B	K	3	2	B
R1232D331B	K	3	3	B

Part Number	Product Code			
	①	②	③	④
R1232D001C	K	0	1	C
R1232D001D	K	0	1	D