

# NUP2301MW6T1

## Low Capacitance Diode Array for ESD Protection in Two Data Lines

NUP2301MW6T1 is a MicroIntegration™ device designed to provide protection for sensitive components from possible harmful electrical transients; for example, ESD (electrostatic discharge).

### Features

- Low Capacitance (2.0 pf Maximum Between I/O Lines)
- Single Package Integration Design
- Provides ESD Protection for JEDEC Standards JESD22 Machine Model = Class C Human Body Model = Class 3B
- Protection for IEC61000-4-2 (Level 4) 8.0 kV (Contact) 15 kV (Air)
- Ensures Data Line Speed and Integrity
- Fewer Components and Less Board Space
- Direct the Transient to Either Positive Side or to the Ground
- Pb-Free Package is Available

### Applications

- T1/E1 Secondary IC Protection
- T3/E3 Secondary IC Protection
- HDSL, IDSL Secondary IC Protection
- Video Line Protection
- Microcontroller Input Protection
- Base Stations
- I<sup>2</sup>C Bus Protection

### MAXIMUM RATINGS (Each Diode) (T<sub>J</sub> = 25°C unless otherwise noted)

Rating	Symbol	Value	Unit
Reverse Voltage	V <sub>R</sub>	70	Vdc
Forward Current	I <sub>F</sub>	200	mAdc
Peak Forward Surge Current	I <sub>FM(surge)</sub>	500	mAdc
Repetitive Peak Reverse Voltage	V <sub>RRM</sub>	70	V
Average Rectified Forward Current (Note 1) (Averaged over any 20 ms Period)	I <sub>F(AV)</sub>	715	mA
Repetitive Peak Forward Current	I <sub>FRM</sub>	450	mA
Non-Repetitive Peak Forward Current	I <sub>FSM</sub>	2.0 1.0 0.5	A
		t = 1.0 μs	
		t = 1.0 ms	
		t = 1.0 S	

Maximum ratings are those values beyond which device damage can occur. Maximum ratings applied to the device are individual stress limit values (not normal operating conditions) and are not valid simultaneously. If these limits are exceeded, device functional operation is not implied, damage may occur and reliability may be affected.

1. FR-5 = 1.0 × 0.75 × 0.062 in.



ON Semiconductor®

<http://onsemi.com>

### PIN CONFIGURATION AND SCHEMATIC

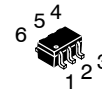
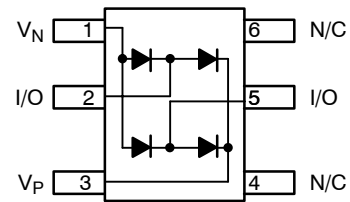

SC-88  
CASE 419B  
STYLE 23

### MARKING DIAGRAM

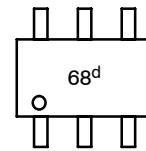

68 = Specific Device Code  
d = Date Code

### ORDERING INFORMATION

Device	Package	Shipping <sup>†</sup>
NUP2301MW6T1	SC-88	3000/Tape & Reel
NUP2301MW6T1G	SC-88 (Pb-Free)	3000/Tape & Reel

<sup>†</sup>For information on tape and reel specifications, including part orientation and tape sizes, please refer to our Tape and Reel Packaging Specifications Brochure, BRD8011/D.

# NUP2301MW6T1

## THERMAL CHARACTERISTICS

Characteristic	Symbol	Max	Unit
Thermal Resistance Junction-to-Ambient	$R_{\theta JA}$	625	$^{\circ}\text{C}/\text{W}$
Lead Solder Temperature Maximum 10 Seconds Duration	$T_L$	260	$^{\circ}\text{C}$
Junction Temperature	$T_J$	-55 to +150	$^{\circ}\text{C}$
Storage Temperature	$T_{stg}$	-55 to +150	$^{\circ}\text{C}$

## ELECTRICAL CHARACTERISTICS ( $T_J = 25^{\circ}\text{C}$ unless otherwise noted) (Each Diode)

Characteristic	Symbol	Min	Typ	Max	Unit
----------------	--------	-----	-----	-----	------

### OFF CHARACTERISTICS

Reverse Breakdown Voltage ( $I_{(BR)} = 100 \mu\text{A}$ )	$V_{(BR)}$	70	-	-	Vdc
Reverse Voltage Leakage Current ( $V_R = 70 \text{ Vdc}$ ) ( $V_R = 25 \text{ Vdc}, T_J = 150^{\circ}\text{C}$ ) ( $V_R = 70 \text{ Vdc}, T_J = 150^{\circ}\text{C}$ )	$I_R$	-	-	2.5 30 50	$\mu\text{A}$   
Capacitance (between I/O pins) ( $V_R = 0 \text{ V}, f = 1.0 \text{ MHz}$ )	$C_D$	-	1.0	2.0	pF
Capacitance (between I/O pin and ground) ( $V_R = 0 \text{ V}, f = 1.0 \text{ MHz}$ )	$C_D$	-	1.6	3	pF
Forward Voltage ( $I_F = 1.0 \text{ mAdc}$ ) ( $I_F = 10 \text{ mAdc}$ ) ( $I_F = 50 \text{ mAdc}$ ) ( $I_F = 150 \text{ mAdc}$ )	$V_F$	-	-	715 855 1000 1250	mVdc    

- FR-5 =  $1.0 \times 0.75 \times 0.062$  in.
- Alumina =  $0.4 \times 0.3 \times 0.024$  in. 99.5% alumina.

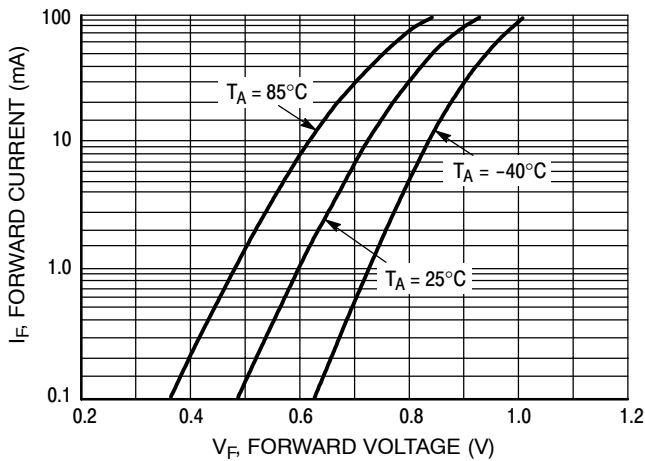

Figure 1. Forward Voltage

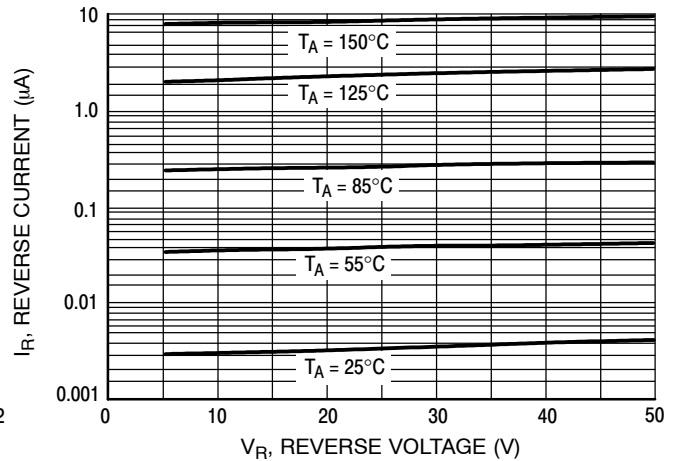

Figure 2. Leakage Current

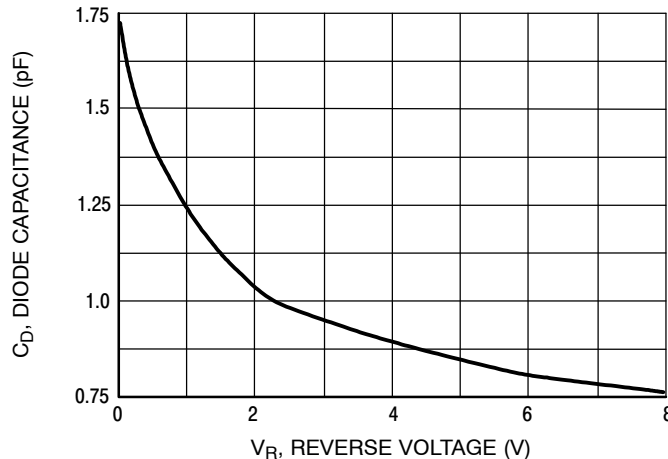

Figure 3. Capacitance

# NUP2301MW6T1

## PACKAGE DIMENSIONS

SC-88/SC70-6/SOT-363  
CASE 419B-02  
ISSUE 02U

NOTES:

1. DIMENSIONING AND TOLERANCING PER ANSI Y14.5M, 1982.
2. CONTROLLING DIMENSION: INCH.
3. 419B-01 OBSOLETE, NEW STANDARD 419B-02.

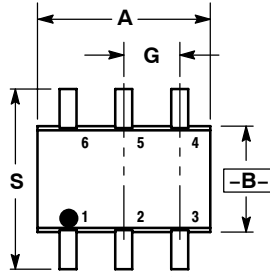

D 6 PL

$\oplus$	0.2 (0.008)	$\text{M}$	$\text{B}$	$\text{M}$
----------	-------------	------------	------------	------------

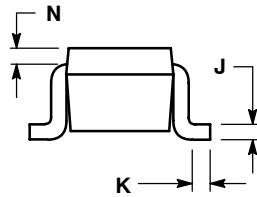
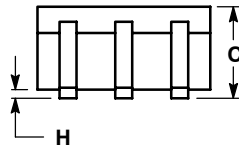

DIM	INCHES		MILLIMETERS	
	MIN	MAX	MIN	MAX
A	0.071	0.087	1.80	2.20
B	0.045	0.053	1.15	1.35
C	0.031	0.043	0.80	1.10
D	0.004	0.012	0.10	0.30
G	0.026 BSC		0.65 BSC	
H	---	0.004	---	0.10
J	0.004	0.010	0.10	0.25
K	0.004	0.012	0.10	0.30
N	0.008 REF		0.20 REF	
S	0.079	0.087	2.00	2.20

### SOLDERING FOOTPRINT\*

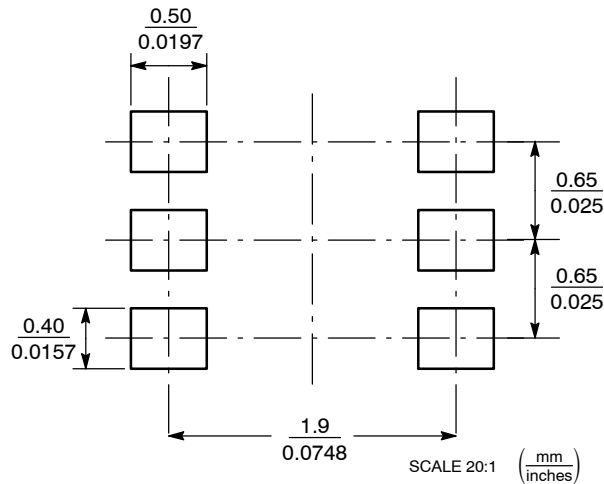

\*For additional information on our Pb-Free strategy and soldering details, please download the ON Semiconductor Soldering and Mounting Techniques Reference Manual, SOLDERRM/D.

# NUP2301MW6T1

MicroIntegration is a trademarks of Semiconductor Components Industries, LLC (SCILLC).

**ON Semiconductor** and  are registered trademarks of Semiconductor Components Industries, LLC (SCILLC). SCILLC reserves the right to make changes without further notice to any products herein. SCILLC makes no warranty, representation or guarantee regarding the suitability of its products for any particular purpose, nor does SCILLC assume any liability arising out of the application or use of any product or circuit, and specifically disclaims any and all liability, including without limitation special, consequential or incidental damages. "Typical" parameters which may be provided in SCILLC data sheets and/or specifications can and do vary in different applications and actual performance may vary over time. All operating parameters, including "Typicals" must be validated for each customer application by customer's technical experts. SCILLC does not convey any license under its patent rights nor the rights of others. SCILLC products are not designed, intended, or authorized for use as components in systems intended for surgical implant into the body, or other applications intended to support or sustain life, or for any other application in which the failure of the SCILLC product could create a situation where personal injury or death may occur. Should Buyer purchase or use SCILLC products for any such unintended or unauthorized application, Buyer shall indemnify and hold SCILLC and its officers, employees, subsidiaries, affiliates, and distributors harmless against all claims, costs, damages, and expenses, and reasonable attorney fees arising out of, directly or indirectly, any claim of personal injury or death associated with such unintended or unauthorized use, even if such claim alleges that SCILLC was negligent regarding the design or manufacture of the part. SCILLC is an Equal Opportunity/Affirmative Action Employer. This literature is subject to all applicable copyright laws and is not for resale in any manner.

## PUBLICATION ORDERING INFORMATION

### LITERATURE FULFILLMENT:

Literature Distribution Center for ON Semiconductor  
P.O. Box 61312, Phoenix, Arizona 85082-1312 USA  
**Phone:** 480-829-7710 or 800-344-3860 Toll Free USA/Canada  
**Fax:** 480-829-7709 or 800-344-3867 Toll Free USA/Canada  
**Email:** [orderlit@onsemi.com](mailto:orderlit@onsemi.com)

**N. American Technical Support:** 800-282-9855 Toll Free  
USA/Canada

**Japan:** ON Semiconductor, Japan Customer Focus Center  
2-9-1 Kamimeguro, Meguro-ku, Tokyo, Japan 153-0051  
**Phone:** 81-3-5773-3850

**ON Semiconductor Website:** <http://onsemi.com>

**Order Literature:** <http://www.onsemi.com/litorder>

For additional information, please contact your  
local Sales Representative.

**NUP2301MW6T1/D**