

## HMIC™ PIN Diode SP2T 20 Watt Switch for 0.05 - 6.0 GHz Higher Power Applications

Rev. V4

### Features

- Exceptional Broadband Performance, 0.05 - 6.0 GHz
- Low Loss: Tx = 0.24 dB Avg @ 2025 MHz, 35mA  
Tx = 0.38 dB Avg @ 3500 MHz, 35mA
- High Isolation: Rx = 31.0 dB Avg @ 2025 MHz  
Rx = 27 dB Avg @ 3500 MHz
- High RF C.W. Input Power: 20 W C.W. (Tx-Ant Port)
- Higher IIP3: > 64 dBm (Tx-Ant Port)
- Suitable for High Power TD-SCDMA & WiMAX Applications
- Surface Mount 3mm PQFN Package
- RoHS\* Compliant and 260°C Re-flow Compatible

### Description and Applications

The MASW-000825-12770T is a compact SP2T PIN diode switch in a lead-free 3mm MLP plastic package that offers extraordinary performance with excellent isolation to loss ratio for both Tx and Rx states. The SP2T provides outstanding 20 W C.W. power handling coupled with 64 dBm IIP3 for maximum switch performance.

The MASW-000825-12770T is a 0.05 - 6.0GHz SP2T High Peak and Average Power PIN diode switch used for T/R or LNA Protect Switch applications such as WiMAX and TD-SCDMA.

This device incorporates a PIN diode die fabricated with M/A-COM Technology Solutions patented Silicon-Glass HMIC™ process. This chip features two silicon pedestals embedded in a low loss, low dispersion glass. The diodes are formed on the top of each pedestal. The topside is fully encapsulated with silicon nitride and has an additional polymer passivation layer. These polymer protective coatings prevent damage and contamination during handling and assembly.

### Ordering Information

Part Number	Package
MASW-000825-12770T	1000 piece reel
MASW-000825-001SMB	Sample Board
MADR-008888-0002TB	Sample Board with recommended external Driver & MASW-000825-12770T Switch

### Functional Diagram (TOP VIEW)

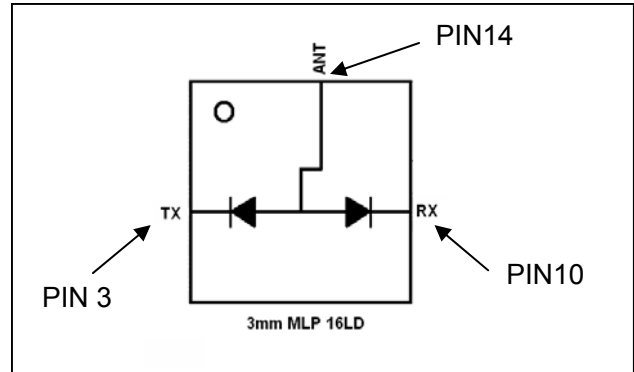

### Circuit Side View

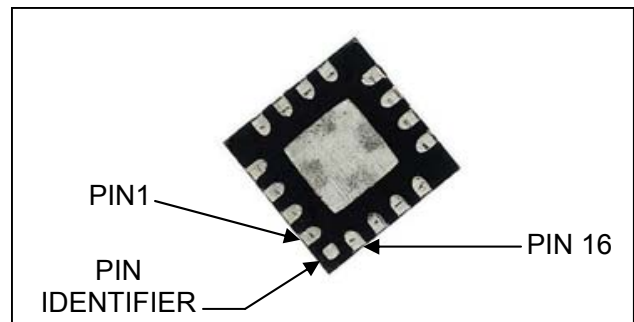

### Pin Configuration:

(Center Metal Area is RF, D.C., and Thermal Ground)

PIN	Function	PIN	Function
1	N/C	9	GND
2	GND	10	Rx
3	T <sub>x</sub>	11	GND
4	GND	12	N/C
5	N/C	13	GND
6	N/C	14	Ant
7	N/C	15	GND
8	N/C	16	N/C

\* Restrictions on Hazardous Substances, European Union Directive 2002/95/EC.

1

**ADVANCED:** Data Sheets contain information regarding a product M/A-COM Technology Solutions is considering for development. Performance is based on target specifications, simulated results, and/or prototype measurements. Commitment to develop is not guaranteed.

**PRELIMINARY:** Data Sheets contain information regarding a product M/A-COM Technology Solutions has under development. Performance is based on engineering tests. Specifications are typical. Mechanical outline has been fixed. Engineering samples and/or test data may be available. Commitment to produce in volume is not guaranteed.

• **North America** Tel: 800.366.2266 • **Europe** Tel: +353.21.244.6400  
• **India** Tel: +91.80.43537383 • **China** Tel: +86.21.2407.1588

Visit [www.macontech.com](http://www.macontech.com) for additional data sheets and product information.

M/A-COM Technology Solutions Inc. and its affiliates reserve the right to make changes to the product(s) or information contained herein without notice.

## HMIC™ PIN Diode SP2T 20 Watt Switch for 0.05 - 6.0 GHz Higher Power Applications

Rev. V4

### Electrical Specifications at +25°C, Characteristic Impedance $Z_0 = 50 \Omega$ , 35mA/28V

Parameter	Symbol	35mA / 28V Conditions	Units	Min.	Typ.	Max.
<b>F = 2.0-2.7 GHz</b>						
Insertion Loss, Rx	Rx, IL	Bias: See Table Below, Pinc= 0 dBm	dB		0.42	0.55
Insertion Loss, Tx	Tx, IL	Bias: See Table Below, Pinc= 0 dBm	dB		0.29	0.38
Isolation, Tx To Rx	Rx, ISO	Bias: See Table Below, Pinc= 0 dBm	dB	24.5	28.6	
Isolation, Rx To Tx	Tx, ISO	Bias: See Table Below, Pinc= 0 dBm	dB	21.3	24.2	
Tx Input Return Loss	Tx, RL	Bias: See Table Below, Pinc= 0 dBm	dB		- 28	
Rx Input Return Loss	Rx, RL	Bias: See Table Below, Pinc= 0 dBm	dB		- 28	
<b>F = 3.3-3.8 GHz</b>						
Insertion Loss, Rx	Rx,IL	Bias: See Table Below, Pinc= 0 dBm	dB		0.56	0.71
Insertion Loss, Tx	Tx, IL	Bias: See Table Below, Pinc= 0 dBm	dB		0.38	0.48
Isolation, Tx To Rx	Rx, ISO	Bias: See Table Below, Pinc= 0 dBm	dB	22	26	
Isolation, Rx To Tx	Tx, ISO	Bias: See Table Below, Pinc= 0 dBm	dB	19.7	21.6	
Tx Input Return Loss	Tx, RL	Bias: See Table Below, Pinc= 0 dBm	dB		- 28	
Rx Input Return Loss	Rx, RL	Bias: See Table Below, Pinc= 0 dBm	dB		-28	
<b>F = 4.9-5.9 GHz</b>						
Insertion Loss, Rx	Rx, IL	Bias: See Table Below, Pinc= 0 dBm	dB		0.95	1.10
Insertion Loss, Tx	Tx, IL	Bias: See Table Below, Pinc= 0 dBm	dB		0.59	0.71
Isolation, Tx To Rx	Rx, ISO	Bias: See Table Below, Pinc= 0 dBm	dB	19.5	22.4	
Isolation, Rx To Tx	Tx, ISO	Bias: See Table Below, Pinc= 0 dBm	dB	16.5	18.5	
Tx Input Return Loss	Tx, RL	Bias: See Table Below, Pinc= 0 dBm	dB		- 25	
Rx Input Return Loss	Rx, RL	Bias: See Table Below, Pinc= 0 dBm	dB		- 24	

Port	Tx	Rx	ANT
Pin	Pin 3	Pin 10	Pin 14
Tx-ANT Isolation	+28V @ 0 ma	0V	+ 5V @ 35 mA
Tx-ANT Insertion Loss	0V	+28V @ 0 ma	+ 5V @ 35 mA
Rx-ANT Isolation	0V	+28V @ 0 ma	+ 5V @ 35 mA
Rx-ANT Insertion Loss	+28V @ 0 ma	0V	+ 5V @ 35 mA

2

**ADVANCED:** Data Sheets contain information regarding a product M/A-COM Technology Solutions is considering for development. Performance is based on target specifications, simulated results, and/or prototype measurements. Commitment to develop is not guaranteed.

**PRELIMINARY:** Data Sheets contain information regarding a product M/A-COM Technology Solutions has under development. Performance is based on engineering tests. Specifications are typical. Mechanical outline has been fixed. Engineering samples and/or test data may be available. Commitment to produce in volume is not guaranteed.

• **North America** Tel: 800.366.2266 • **Europe** Tel: +353.21.244.6400  
 • **India** Tel: +91.80.43537383 • **China** Tel: +86.21.2407.1588

Visit [www.macontech.com](http://www.macontech.com) for additional data sheets and product information.

M/A-COM Technology Solutions Inc. and its affiliates reserve the right to make changes to the product(s) or information contained herein without notice.

## HMIC™ PIN Diode SP2T 20 Watt Switch for 0.05 - 6.0 GHz Higher Power Applications

Rev. V4

### Electrical Specifications at +25°C, Characteristic Impedance, $Z_0 = 50 \Omega$

Parameter	Symbol	Conditions	Units	Min	Typ	Max
Tx 2 <sup>nd</sup> Harmonic	Tx 2Fo	Fo=2.010 GHz, Tx = +5.0 V@ +35mA, Rx =+28V @ 0mA Pin = + 30 dBm, Tx To Antenna	dBc		70	
Tx 3 <sup>rd</sup> Harmonic	Tx 3Fo	Fo= 2.010 GHz, Tx = +5.0 V@ +35mA, Rx =+28V @ 0mA Pin = + 30 dBm, Tx To Antenna	dBc		86	
Tx Input Third Order Intercept Point	Tx IIP3	Tx = +5.0 V@ +35mA, Rx =+28V @ 0mA Pi= +20 dBm, F1 = 2.010 GHz, F2 = 2.020 GHz, Tx To Antenna	dBm		64	
Tx C.W. Input Power <sup>2</sup>	Tx CW Pinc	Tx = +5.0 V@ +35mA, Rx =+28V @ 0mA F = 2.010, 3.500 GHz, Tx To Antenna	dBm W			43 20
Tx Peak Input Power	Tx Pk Pinc	Tx = +5.0 V@ +35mA, Rx =+28V @ 0mA F = 2.010 GHz, Tx To Antenna ( 5 $\mu$ S RF Pulse Width, 1% Duty 1.10:1 Ant VSWR )	dBm W			53 200
Rx C.W. Input Power	Rx CW Pinc	Rx = +5.0 V@ +35mA, Tx =+28V @ 0mA F = 2.010 GHz, Antenna to Rx	dBm W			39 8
Tx Input P1dB	Tx P1dB	Tx = +5.0 V@ +35mA, Rx =+28V @ 0mA F = 2.010, GHz, Tx To Antenna	dBm		>43	
Tx RF Switching Speed	$\tau_{RF}$	( 10% - 90% RF Voltage) Tx = +5.0 V@ +35mA, Rx =+28V @ 0mA F = 2.010 GHz, Tx To Antenna 1MHz Rep Rate in Modulating Mode	ns		200	

### Absolute Maximum Ratings<sup>1</sup> @ T<sub>A</sub> = +25 °C (unless otherwise specified)

Parameter	Absolute Maximum
Forward Current	100 mA
Reverse Voltage ( RF & D.C. )	-140 V
Operating Temperature	-40 °C to +85 °C
Storage Temperature	-55 °C to +150 °C
Junction Temperature	+175 °C
Tx Incident C.W. Power <sup>2</sup>	20 W C.W.
Tx Peak Incident Power With 3.0:1 Maximum Ant VSWR	150 W, 5 $\mu$ S P.W., 1% Duty

1. Exceeding these limits may cause permanent damage.
2. Refer to page 7 of the datasheet for power handling curves.

### Handling Procedures

Please observe the following precautions to avoid damage:

### Static Sensitivity

These devices are rated Class 1B Human Body. Proper ESD control techniques should be used when handling these devices.

3

**ADVANCED:** Data Sheets contain information regarding a product M/A-COM Technology Solutions is considering for development. Performance is based on target specifications, simulated results, and/or prototype measurements. Commitment to develop is not guaranteed.

**PRELIMINARY:** Data Sheets contain information regarding a product M/A-COM Technology Solutions has under development. Performance is based on engineering tests. Specifications are typical. Mechanical outline has been fixed. Engineering samples and/or test data may be available. Commitment to produce in volume is not guaranteed.

• **North America** Tel: 800.366.2266 • **Europe** Tel: +353.21.244.6400  
• **India** Tel: +91.80.43537383 • **China** Tel: +86.21.2407.1588

Visit [www.macontech.com](http://www.macontech.com) for additional data sheets and product information.

M/A-COM Technology Solutions Inc. and its affiliates reserve the right to make changes to the product(s) or information contained herein without notice.

## D.C. Bias to RF Truth Table

RF State	TTL & D.C. Bias Conditions	Voltage at Common Anode
Low Loss Tx-Ant & Isolation Tx-Rx	TTL = 1 + 5V @ 35 mA ( Tx ), + 28V @ 0 mA ( Rx )	+ 0.9 V
Low Loss Ant-Rx & Isolation Rx-Tx	TTL = 0 + 5V @ 35 mA ( Rx ), + 28V @ 0 mA ( Tx )	+ 0.9 V

## Driver and SP2T Schematic with Positive Voltage

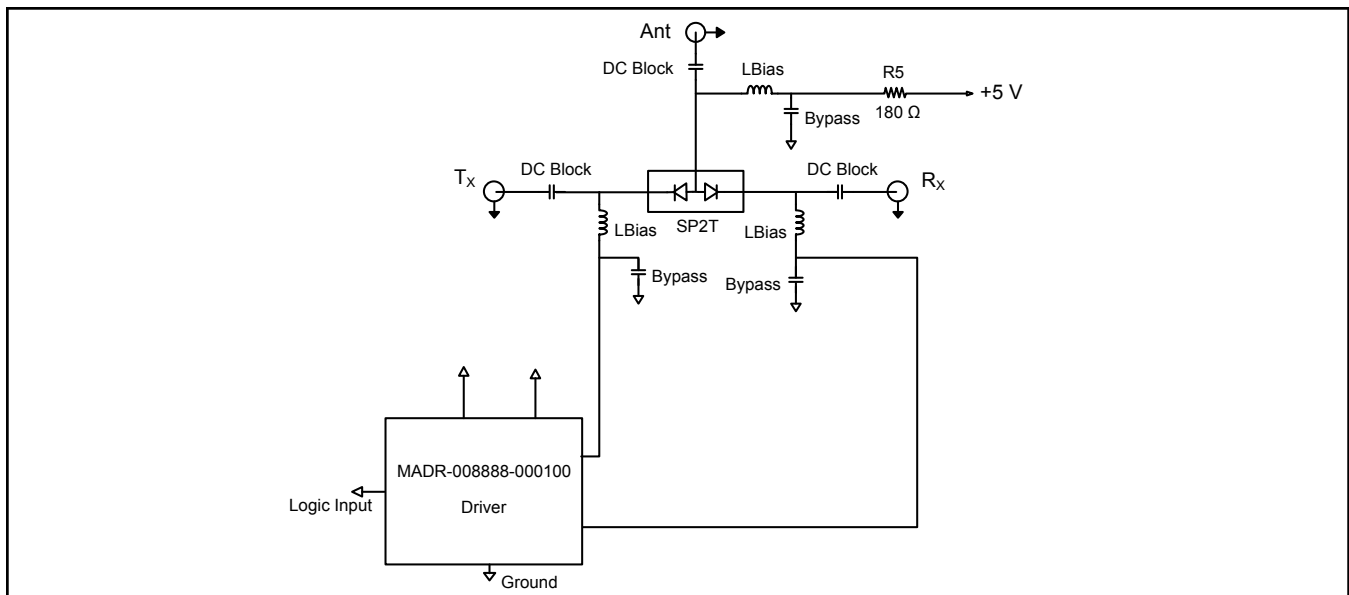

### Notes:

1. Data is taken on M/A-COM evaluation board 1000029181-0000001 @ 25C by removing peripheral board losses ( connectors, transmission line, and bias elements ).
2. Typical PIN Diode Forward Voltage = + 0.9 V @ + 35 mA for Insertion Loss.  
Typical PIN Diode Reverse Voltage = 28 V – 1.0 V = 27 V for Isolation.
3. Switch is Asymmetrical, + 43 dBm RF C.W. Input Power Applies to Tx Port Only.
4. Center Ground Area of MLP 3mm Package must be Attached to Thermal Ground for Optimum RF Power Performance.
5. M/A-Com Recommends the usage of the [MADR-008888-000100](#) driver with this switch.

### Assembly Note:

A typical soldering process profile and handling instructions are provided in Application Notes, [S2083](#) “Surface Mount Instructions for QFN / DFN Packages” on the M/A-Com website at [www.macomtech.com](http://www.macomtech.com)

## Typical Small Signal Performance at +25°C, Characteristic Impedance, $Z_0 = 50 \Omega$

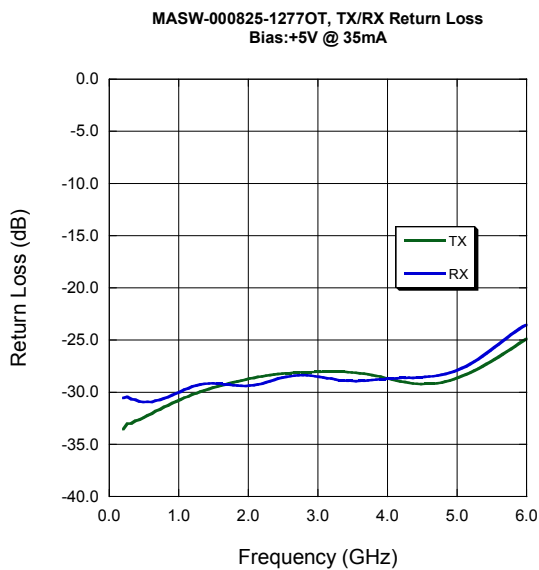
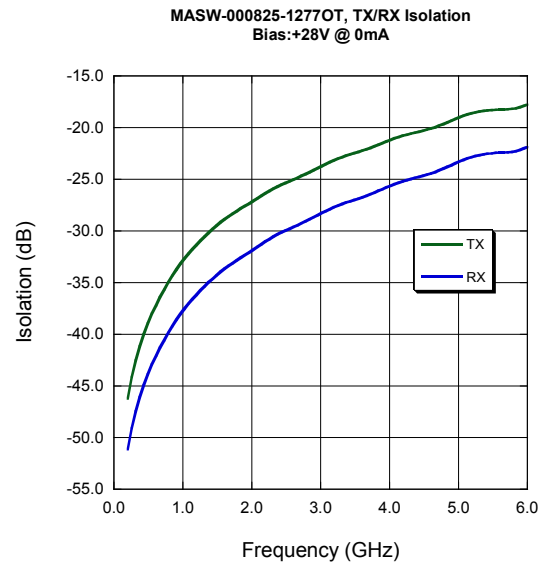
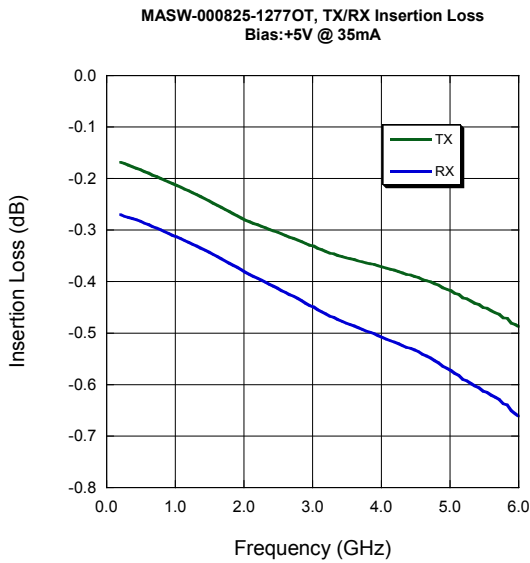

## Typical Small Signal Performance over Temperature Characteristic Impedance, $Z_0 = 50 \Omega$

**MASW-000825-12770T, TX to Antenna**  
TX Diode Tj Vs. Bias Current  
Bias: TX = +5V @ 20mA and 30mA, RX = +25V @ 0mA, Fo = 2010 MHz  
PCB Temperature is +25°C

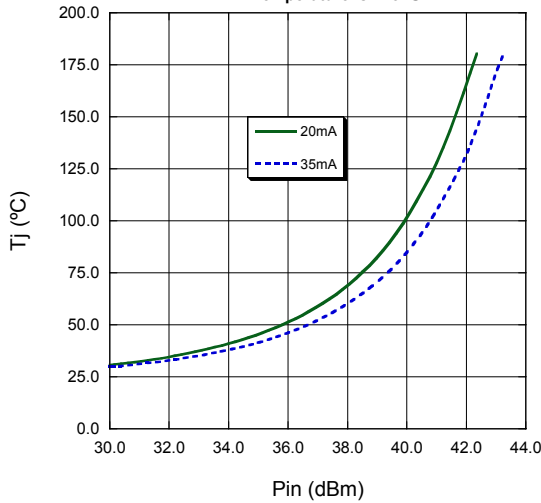

**MASW-000825-12770T, TX to Antenna**  
Maximum Pin Vs. PCB/Heatsink Temperature Vs. Bias Current  
Bias: +5V @ 20mA and 30mA, RX = +25V @ 0mA, Fo = 2010 MHz

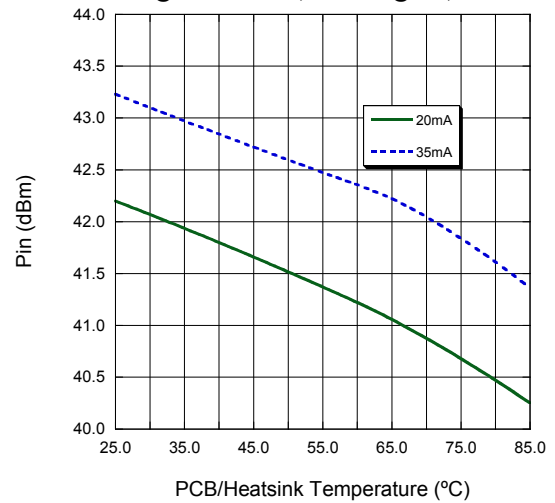

**MASW-000825-12770T, TX Insertion Loss Vs. Temperature**  
Bias: +5V @ 35mA

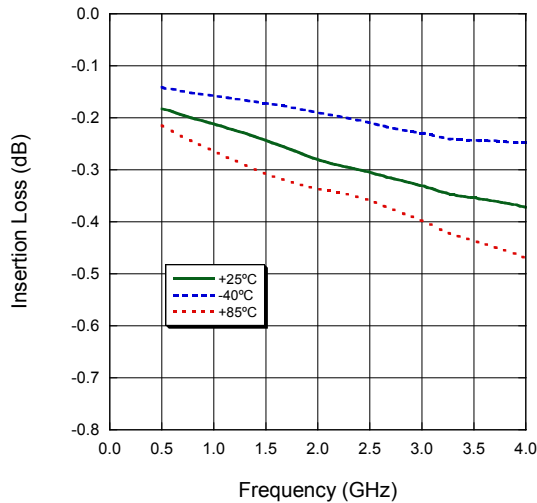

**MASW-000825-12770T, RX Insertion Loss Vs. Temperature**  
Bias: +5V @ 35mA

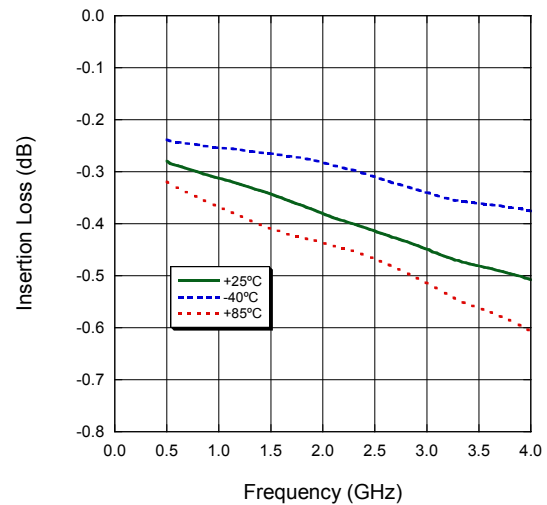

## Typical Small Signal Performance over temperature Characteristic Impedance, $Z_0 = 50 \Omega$

MASW-000825-12770T, TX Insertion Loss Vs. Temperature  
Bias: +5V @ 35mA

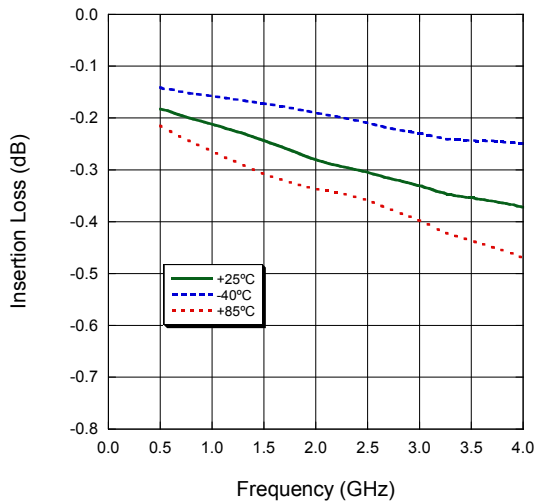

MASW-000825-12770T, RX Isolation Vs. Temperature  
Bias: +28V @ 0mA

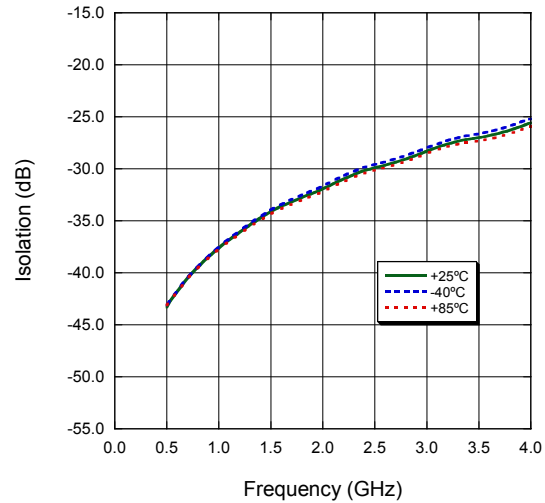

MASW-000825-12770T, TX Return Loss Vs. Temperature  
Bias: +5V @ 35mA

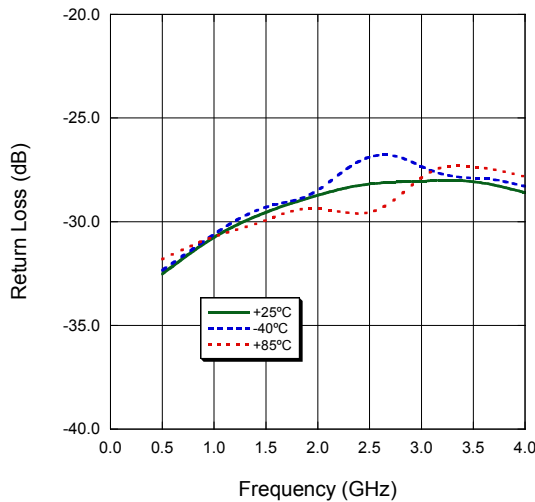

MASW-000825-12770T, RX Return Loss Vs. Temperature  
Bias: +5V @ 35mA

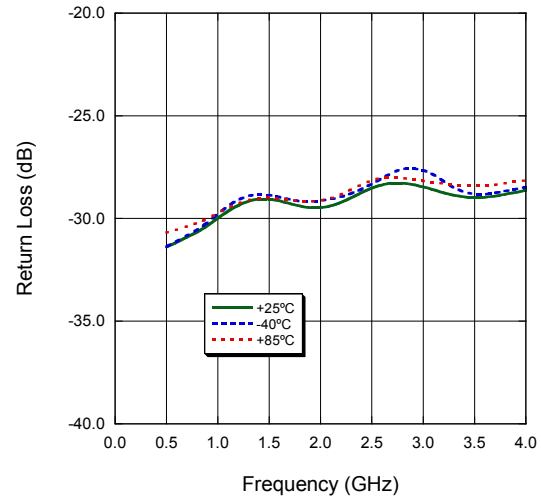

# MASW-000825-12770T

HMIC™ PIN Diode SP2T 20 Watt Switch for  
0.05 - 6.0 GHz Higher Power Applications

Rev. V4

## MASW-000825-12770T Outline† – Lead Free 3mm PQFP-N 16 Lead Saw Singulated

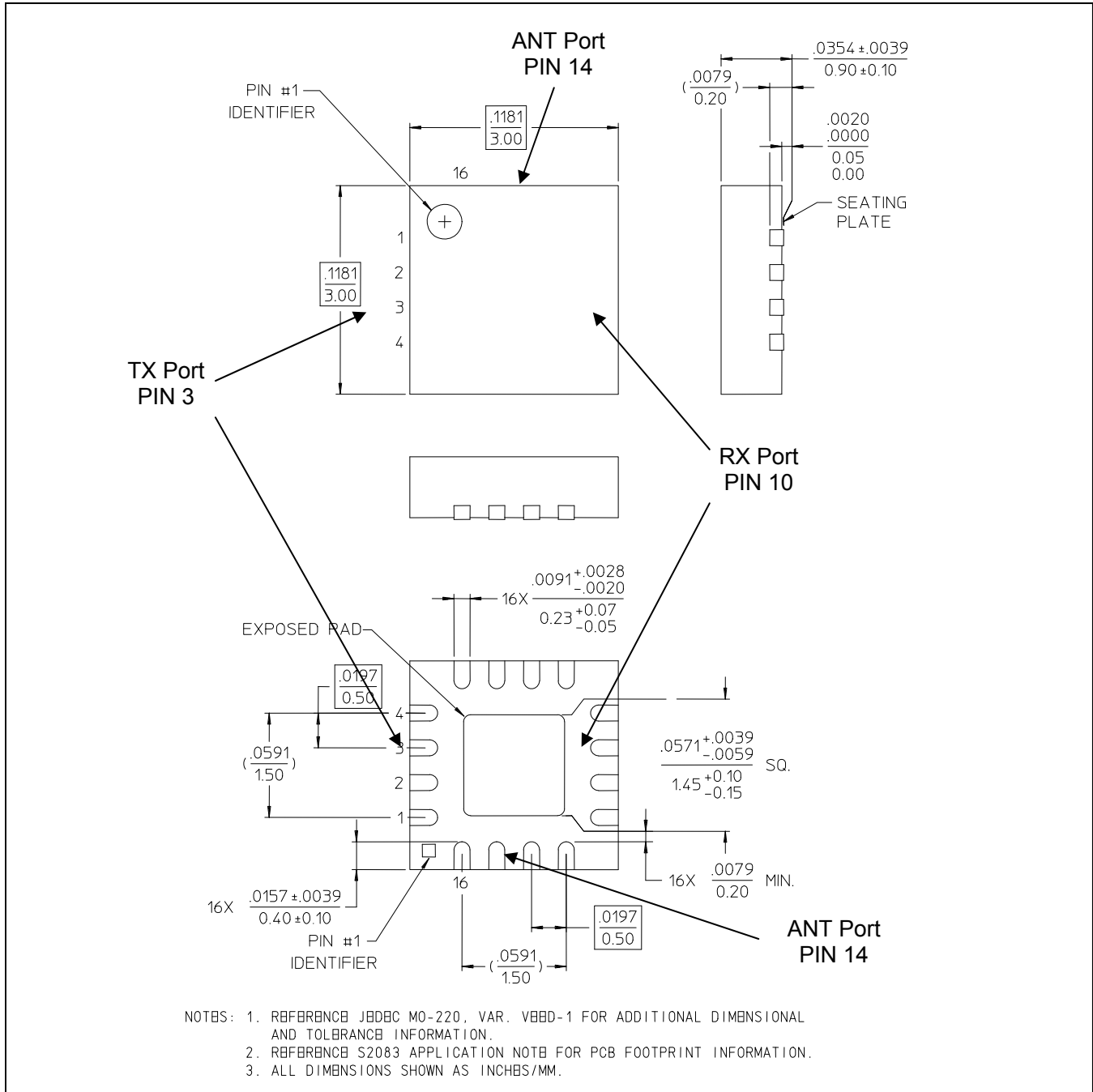

† Reference Application Note S2083 for lead-free solder reflow recommendations.  
Meets JEDEC moisture sensitivity level 1 requirements.

**ADVANCED:** Data Sheets contain information regarding a product M/A-COM Technology Solutions is considering for development. Performance is based on target specifications, simulated results, and/or prototype measurements. Commitment to develop is not guaranteed.

**PRELIMINARY:** Data Sheets contain information regarding a product M/A-COM Technology Solutions has under development. Performance is based on engineering tests. Specifications are typical. Mechanical outline has been fixed. Engineering samples and/or test data may be available. Commitment to produce in volume is not guaranteed.

• **North America** Tel: 800.366.2266 • **Europe** Tel: +353.21.244.6400  
• **India** Tel: +91.80.43537383 • **China** Tel: +86.21.2407.1588

Visit [www.maacotech.com](http://www.maacotech.com) for additional data sheets and product information.

M/A-COM Technology Solutions Inc. and its affiliates reserve the right to make changes to the product(s) or information contained herein without notice.