

1 GHz Low Noise Silicon MMIC Amplifier

Technical Data

Features

- Internally Biased, Single 3 V Supply (6 mA)
- 3.5 dB NF
- 13 dB Gain
- Unconditionally Stable

Applications

- LNA or IF Amplifier for Cellular, Cordless, Special Mobile Radio, PCS, ISM, and Wireless LAN Applications

SOT-143 Surface Mount Package

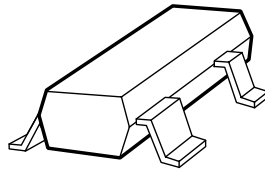

Pin Connections and Package Marking

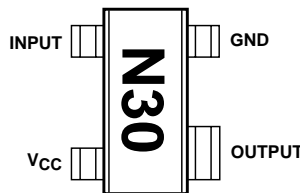

Equivalent Circuit (Simplified)

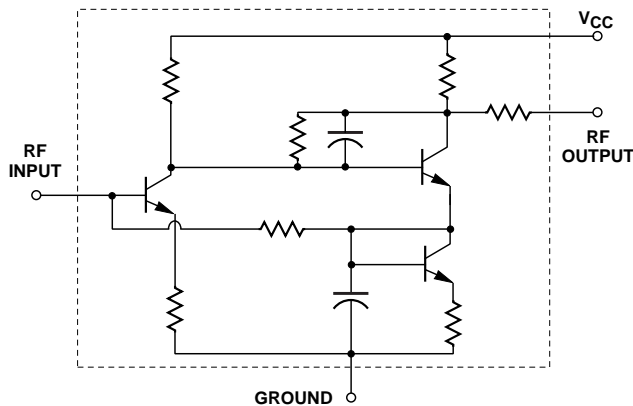

INA-30311

Description

Hewlett-Packard's INA-30311 is a Silicon monolithic amplifier for applications to 1.0 GHz. Packaged in a miniature SOT-143 package, it requires very little board space.

The INA-30311 uses an internally biased topology which eliminates the need for external components and provides decreased sensitivity to ground inductance.

The INA-30311 is designed with an output impedance that varies from near 200 Ω at low frequencies to near 50 Ω at higher frequencies. This provides a matching advantage for IF circuits, as well as improved power efficiency, making it suitable for battery powered designs.

The INA-30311 is fabricated using HP's 30 GHz f_{MAX} ISOSAT™ Silicon bipolar process which uses nitride self-alignment sub-micrometer lithography, trench isolation, ion implantation, gold metallization, and polyimide intermetal dielectric and scratch protection to achieve superior performance, uniformity, and reliability.

Absolute Maximum Ratings

Symbol	Parameter	Units	Absolute Maximum ^[1]
V _{CC}	Device Voltage, to ground	V	12
P _{in}	CW RF Input Power	dBm	+13
T _j	Junction Temperature	°C	150
T _{STG}	Storage Temperature	°C	-65 to 150

Thermal Resistance^[2]:

$$\theta_{j-c} = 550^{\circ}\text{C/W}$$

Notes:

1. Operation of this device above any one of these limits may cause permanent damage.
2. T_C = 25°C (T_C is defined to be the temperature at the package pins where contact is made to the circuit board).

INA-30311 Electrical Specifications^[3], T_C = 25°C, Z_O = 50 Ω, V_{CC} = 3 V

Symbol	Parameters and Test Conditions	Units	Min.	Typ.	Max.
G _p	Power Gain (S ₂₁ ²) f = 900 MHz	dB	11	13	
NF	Noise Figure f = 900 MHz	dB		3.5	
P _{1dB}	Output Power at 1 dB Gain Compression f = 900 MHz	dBm		-11	
IP ₃	Third Order Intercept Point f = 900 MHz	dBm		-2	
VSWR	Input VSWR f = 900 MHz			1.7	
I _{cc}	Device Current	mA		6.3	7.5
t _d	Group Delay f = 900 MHz	ps		325	

INA-30311 Typical Scattering Parameters^[3], T_C = 25°C, Z_O = 50 Ω, V_{CC} = 3 V

Freq. GHz	S ₁₁		S ₂₁			S ₁₂			S ₂₂		K Factor
	Mag	Ang	dB	Mag	Ang	dB	Mag	Ang	Mag	Ang	
0.05	0.09	-1	16.12	6.40	-6	-38.1	0.012	2	0.57	-1	4.35
0.10	0.09	-2	16.11	6.39	-12	-38.2	0.012	4	0.56	-3	4.43
0.20	0.10	-6	16.12	6.40	-25	-38.4	0.012	8	0.56	-7	4.41
0.30	0.13	-16	16.14	6.41	-38	-38.9	0.011	13	0.55	-11	4.83
0.40	0.16	-29	16.07	6.36	-52	-39.4	0.011	19	0.54	-14	4.88
0.50	0.18	-42	15.90	6.24	-66	-40.1	0.010	27	0.52	-18	5.60
0.60	0.21	-59	15.56	6.00	-81	-40.7	0.009	40	0.50	-20	6.58
0.70	0.22	-75	15.04	5.65	-95	-40.7	0.009	57	0.47	-23	7.26
0.80	0.24	-92	14.34	5.21	-109	-39.6	0.011	74	0.46	-24	6.49
0.90	0.25	-107	13.44	4.70	-122	-37.6	0.013	86	0.44	-24	6.23
1.00	0.26	-122	12.53	4.23	-135	-35.5	0.017	94	0.43	-25	5.35
1.20	0.27	-144	10.50	3.35	-155	-32.3	0.024	100	0.42	-26	4.83
1.40	0.27	-162	8.50	2.66	-173	-29.6	0.033	101	0.42	-27	4.43
1.60	0.27	-177	6.69	2.16	172	-27.5	0.042	100	0.42	-28	4.31
1.80	0.27	173	5.01	1.78	159	-25.7	0.052	99	0.42	-30	4.22
2.00	0.27	163	3.58	1.51	147	-24.1	0.062	97	0.42	-32	4.17
2.20	0.27	156	2.35	1.31	136	-22.5	0.075	95	0.42	-35	3.97
2.40	0.26	150	1.21	1.15	126	-21.4	0.085	92	0.41	-37	4.04
2.50	0.26	147	0.75	1.09	122	-20.9	0.091	91	0.41	-39	3.99

Note:

3. Reference plane per Figure 9 in Applications Information section.

INA-30311 Typical Performance, $T_C = 25^\circ\text{C}$, $Z_O = 50\ \Omega$, $V_{CC} = 3\ \text{V}$

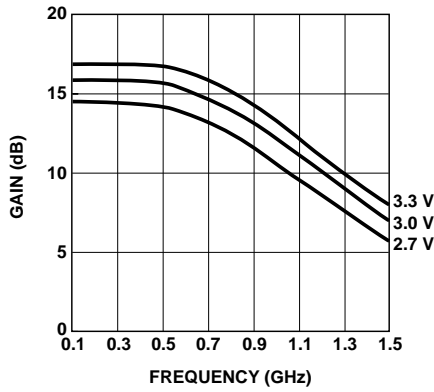

Figure 1. Power Gain vs. Frequency and Voltage.

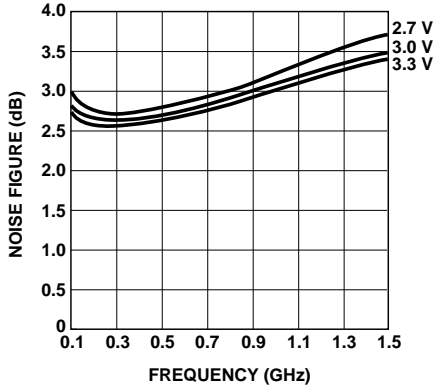

Figure 2. Noise Figure vs. Frequency and Voltage.

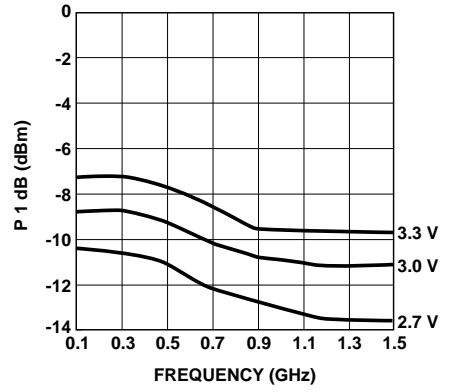

Figure 3. Output Power for 1 dB Gain Compression vs. Frequency and Voltage.

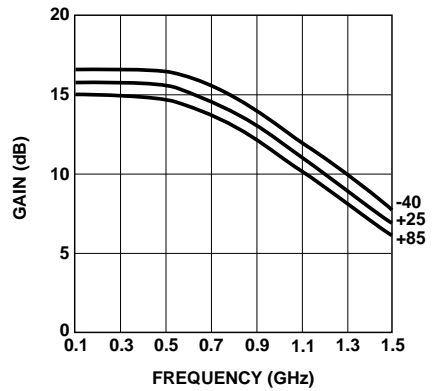

Figure 4. Gain vs. Frequency and Temperature.

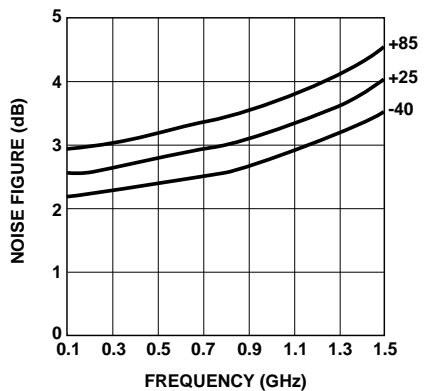

Figure 5. Noise Figure vs. Frequency and Temperature.

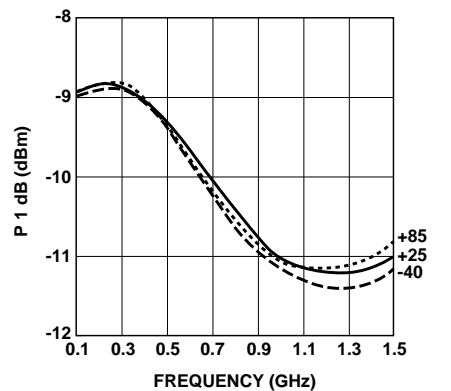

Figure 6. Output Power for 1 dB Gain Compression vs. Frequency and Temperature.

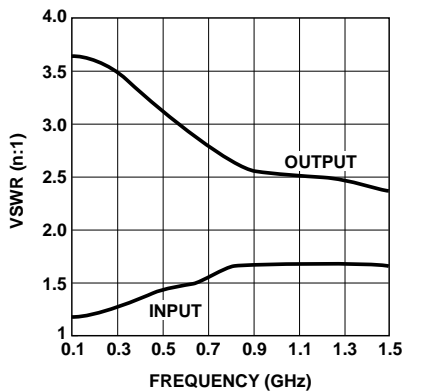

Figure 7. Input and Output VSWR vs. Frequency.

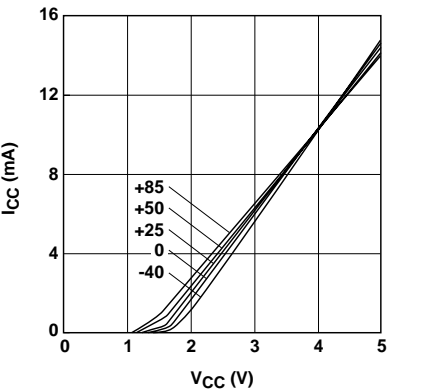

Figure 8. Supply Current vs. Voltage and Temperature.

INA-30311 Applications Information

Introduction

The INA-30311 is a silicon RF integrated circuit that provides an easy-to-use solution for low noise or multi-purpose gain block applications up to 1000 MHz. This two-stage amplifier design uses resistive feedback to provide flat gain over a wide frequency range. This device is assembled in a miniature, surface mount package and is intended for use in low cost wireless communication products.

A unique feature of the INA-30311 is that it is designed with a 50 Ω input impedance and an output impedance that approaches 200 Ω at lower frequencies. This impedance converting feature is very useful for applications such as receiver IF circuits in which the INA-30311 is followed by high input impedance devices like signal processing circuits, filters, or mixed signal ICs.

In addition to simplifying the match to higher impedance devices, a key benefit of the higher output impedance feature is an improvement in power efficiency.

Phase Reference Planes

The positions of the reference planes used to measure S-Parameters are shown in Figure 9. As seen in the illustration, the reference planes are located at the point where the package leads contact the test circuit.

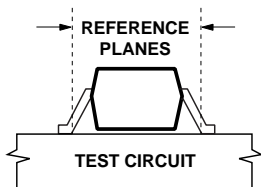

Figure 9. Reference Planes.

Biasing

The INA-30311 is a voltage biased device and operates from a single +3 volt power supply. With a current drain of 6 mA, this amplifier is suitable for use in battery powered applications. All bias circuitry is fully integrated into the IC eliminating the need for external DC components. RF performance is very stable for 3-volt battery supplies that may range from 2.7 to 3.3 volts, depending on battery “freshness” or state of charge in the case of rechargeable batteries.

While the INA-30311 was designed for use in +3 volt battery powered applications, the internal bias regulation circuitry allows it to be used with any power supply voltage from +2.7 to +5 volts.

Typical Configurations

The way in which the INA-30311 is used depends on the particular application and operating frequency.

- For receiver IF amplifier applications up to several hundred MHz, the relatively higher output impedance level of the INA-30311 may be used to advantage when interfacing directly with devices having higher than 50 Ω input impedances, such as certain signal processing or mixed signal ICs. This application is shown in Figure 10.

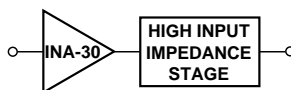

Figure 10. INA-30311 Driving a High Input Impedance Stage.

- A second implementation, shown in Figure 11, uses a simple reactive network at the amplifier’s output to match the output impedance to 50 Ω.

This matched output arrangement will provide an additional 0.9 dB of gain and output power at 900 MHz when driving into a 50 Ω stage.

- The third way to use the INA-30311 is to simply cascade several INA-30311’s with 50 Ω stages and neglect the effects of the output mismatch.

The 50 Ω cascade without impedance matching, shown in Figure 12, trades off the improvement in stage gain and output power for a more simplified interstage circuit and reduced circuit board space.

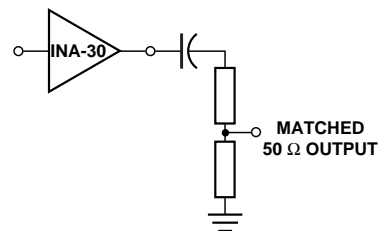

Figure 11. Impedance Matched Output.

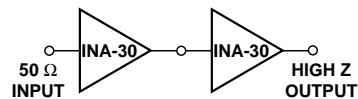

Figure 12. Simple Cascade without Impedance Matching.

Operating Details

The basic application of the INA-30311 is shown in Figure 13. DC blocking capacitors should be placed in series with the RF Input and RF Output to isolate adjoining circuits from the internal bias voltages that are present at these terminals. The values of the blocking capacitors are determined by the lowest frequency of operation for a particular application. The capacitor's reactances are chosen to be 5% or less of the amplifier's input or output impedance at the lowest operating frequency. For example, an amplifier to be used in an application covering the 902 to 928 MHz band would require an input blocking capacitor of at least 70 pF, which is 2.5 Ω of reactance, or 5% of 50 Ω at 902 MHz.

The V_{CC} connection to the amplifier must be RF bypassed by placing a capacitor to ground directly at the bias pin of the package. Like the DC blocking capacitors, the value of the V_{CC} bypass capacitor is determined by the lowest operating frequency for the amplifier. This value is typically the same as that of the DC blocking capacitors. If long bias lines are

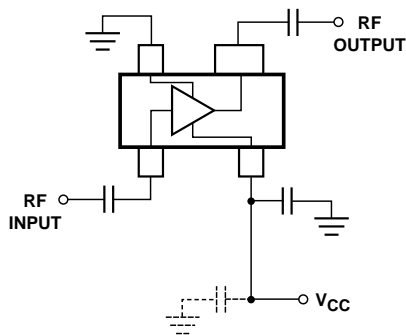

Figure 13. Basic Amplifier Application.

used to the amplifier to the V_{CC} supply, additional bypass capacitors may be needed to prevent resonances that would otherwise result in undesirable gain responses. A well-bypassed V_{CC} line is also desirable to prevent possible oscillations that may occur due to feedback through the bias line from other stages in a cascade.

Adequate grounding is needed to obtain maximum performance. The ground pin of the INA-30311 should be connected to directly to RF ground by using plated through holes (vias) near the package terminals.

FR-4 or G-10 PCB material is a good choice for most low cost wireless applications. Typical board thickness is 0.025 or 0.031 inches. The width of 50 Ω microstriplines in these PCB thicknesses is also convenient for mounting chip components such as the series DC blocking capacitors.

50 Ω Example

The demonstration circuit in Figure 14 shows the INA-30311 used without output impedance matching and is an example of the cascade depicted in Figure 12. This layout illustrates the simplest implementation of the INA-30311 by using 50 Ω microstriplines with DC blocking capacitors for both the input and output. The V_{CC} supply connection is RF bypassed very close to the lead of the RFIC. Provision is also made for an additional bypass capacitor on the V_{CC} line near the edge of the PCB.

900 MHz Matched Example

This section describes a demonstration circuit for 900 MHz that is based on the matched output configuration shown in Figure 11.

The output VSWR of the INA-30311 is approximately 2.6:1 at 900 MHz and results in a 0.9 dB mismatch loss when used in a 50 Ω system. The use of a simple impedance matching circuit at the output will increase both gain and output power by 0.9 dB. The noise figure of the amplifier remains the same and does not depend on whether or not the output is matched.

There are many circuit topologies that may be used to match the output impedance of the INA-30311 to a 50 Ω load. The example presented in Figure 15 is designed to match the amplifier's output for frequencies near 900 MHz.

This circuit is representative for applications in the 800 MHz cellular or 900 MHz unregulated frequency bands. This example uses a series capacitor to resonate with a shunt, high impedance transmission line. The transmission line is tapped at a 50 Ω level for the output. This circuit provides the desired impedance transformation with a minimum of components, using only one chip capacitor that also doubles as the output DC block.

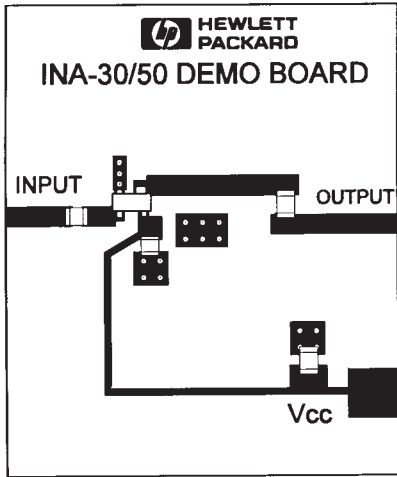

Figure 14. 50 Ω Input/Output Example.

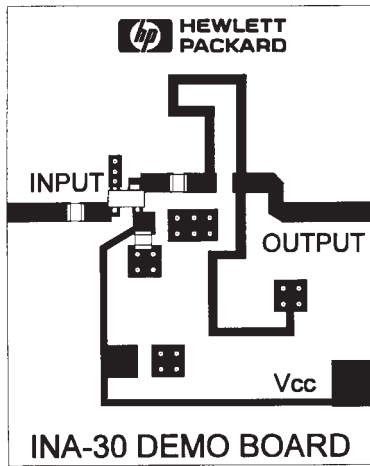
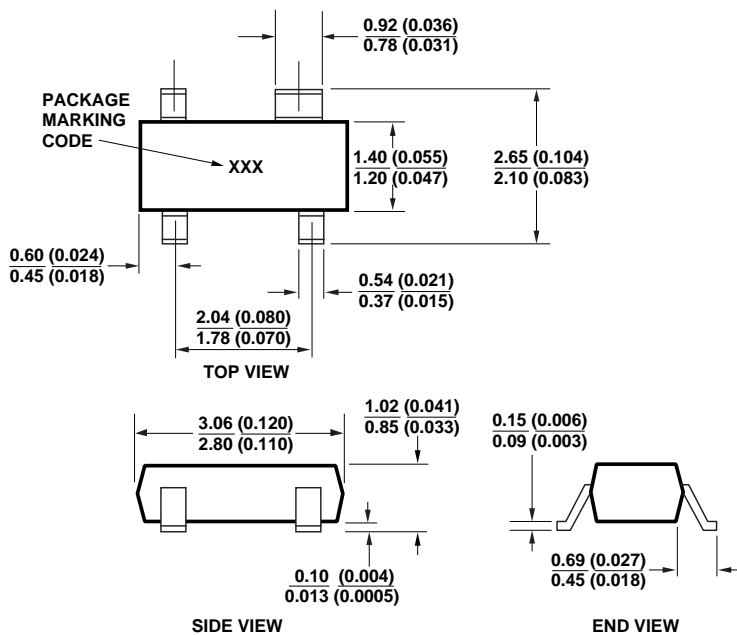

Figure 15. Matched Output Example.

INA-30311 Part Number Ordering Information

Part Number	Devices per Container	Container
INA-30311-TR1	3,000	7" reel
INA-30311-BLK	100	Antistatic bag

Package Dimensions



DIMENSIONS ARE IN MILLIMETERS (INCHES)