



SFT11 THRU SFT18

1.0 AMP. Super Fast Rectifiers

	Voltage Range 50 to 600 Volts Current 1.0 Ampere
--	---

Features

- ✧ Low forward voltage drop
- ✧ High current capability
- ✧ High reliability
- ✧ High surge current capability

Mechanical Data

- ✧ Cases: Molded plastic
- ✧ Epoxy: UL 94V-O rate flame retardant
- ✧ Lead: Axial leads, solderable per MIL-STD-202, Method 208 guaranteed
- ✧ Polarity: Color band denotes cathode end
- ✧ High temperature soldering guaranteed: 260°C/10 seconds/.375", (9.5mm) lead lengths at 5 lbs., (2.3kg) tension
- ✧ Weight: 0.20 gram

TS-1

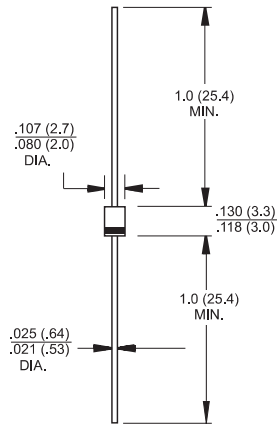

Dimensions in inches and (millimeters)

Maximum Ratings and Electrical Characteristics

Rating at 25°C ambient temperature unless otherwise specified.
 Single phase, half wave, 60 Hz, resistive or inductive load.
 For capacitive load, derate current by 20%

Type Number	Symbol	SFT 11	SFT 12	SFT 13	SFT 14	SFT 15	SFT 16	SFT 17	SFT 18	Units
Maximum Recurrent Peak Reverse Voltage	V_{RRM}	50	100	150	200	300	400	500	600	V
Maximum RMS Voltage	V_{RMS}	35	70	105	140	210	280	350	420	V
Maximum DC Blocking Voltage	V_{DC}	50	100	150	200	300	400	500	600	V
Maximum Average Forward Rectified Current .375 (9.5mm) Lead Length @ $T_A = 55^\circ C$	$I_{(AV)}$	1.0								A
Peak Forward Surge Current, 8.3 ms Single Half Sine-wave Superimposed on Rated Load (JEDEC method)	I_{FSM}	30								A
Maximum Instantaneous Forward Voltage @ 1.0A	V_F	0.95			1.3		1.7			V
Maximum DC Reverse Current @ $T_A=25^\circ C$ at Rated DC Blocking Voltage @ $T_A=100^\circ C$	I_R	5.0 100								uA uA
Maximum Reverse Recovery Time (Note 1)	T_{rr}	35								nS
Typical Junction Capacitance (Note 2)	C_j	30				15				pF
Typical Thermal Resistance (Note 3)	$R_{\theta JA}$	100								°C/W
Operating Temperature Range	T_J	-65 to +125								°C
Storage Temperature Range	T_{STG}	-65 to +150								°C

Notes: 1. Reverse Recovery Test Conditions: $I_F=0.5A$, $I_R=1.0A$, $I_{RR}=0.25A$
 2. Measured at 1 MHz and Applied Reverse Voltage of 4.0 V D.C.
 3. Mount on Cu-Pad Size 5mm x 5mm on PCB.

RATINGS AND CHARACTERISTIC CURVES (SFT11 THRU SFT18)

FIG.1- REVERSE RECOVERY TIME CHARACTERISTIC AND TEST CIRCUIT DIAGRAM

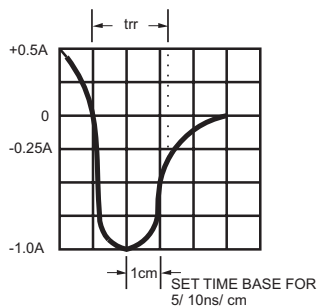
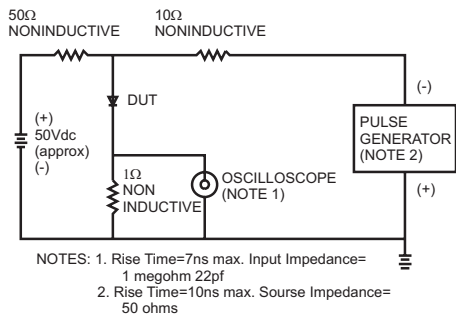

FIG.2- MAXIMUM AVERAGE FORWARD CURRENT DERATING

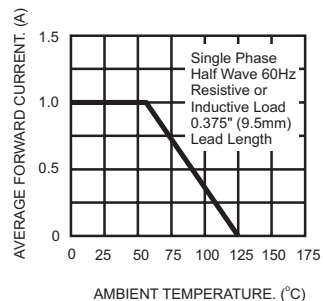

FIG.3- TYPICAL REVERSE CHARACTERISTICS

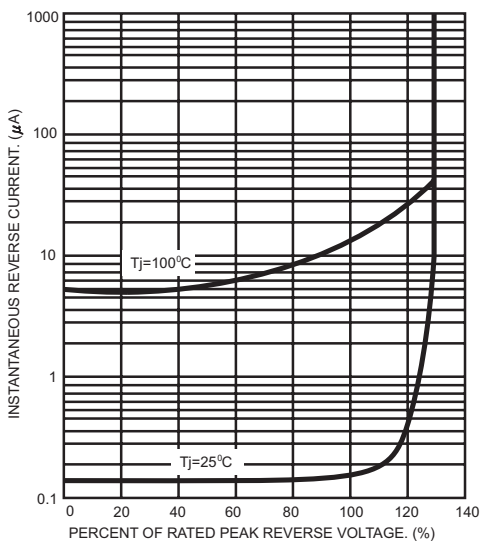

FIG.4- TYPICAL FORWARD CHARACTERISTICS

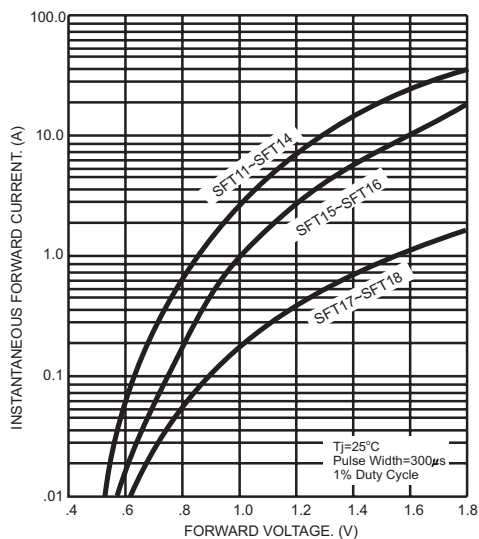

FIG.5- MAXIMUM NON-REPETITIVE FORWARD SURGE CURRENT

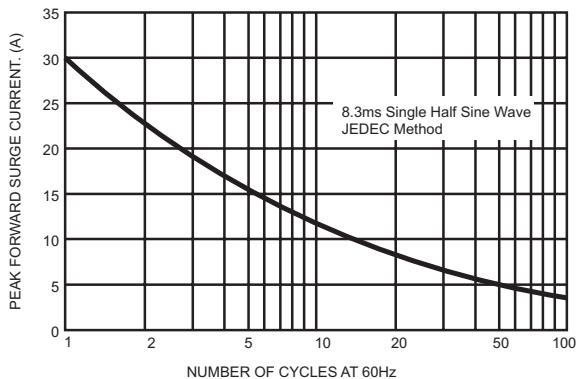

FIG.6- TYPICAL JUNCTION CAPACITANCE

