

SMD Micro Embedded Infrared Receiver Module

1-05-08-30 Preliminary

Module No.: PIC-9011ATE

1. Features:

- Microminiature size
- Embedded protection
- CMOS Design
- Built-in exclusive IC
- Wide half angle & long reception distance
- Good noise-proof capability
- High immunity against ambient light
- High protection ability to EMI
- Top view
- Wide voltage operating: 2.7V ~ 5.5V

Dimensions

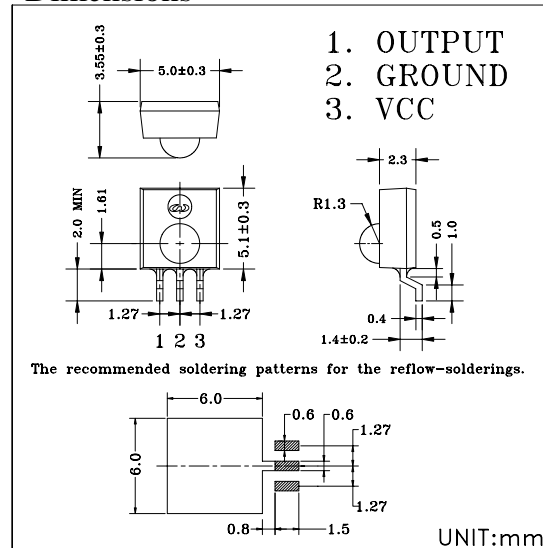

2. Applications

- ▣ AV instruments (Audio, TV, VCR, CD player)
- ▣ Home appliances (Air-conditioner, Fan, Light.)
- ▣ Remote control for wireless devices

3. Absolute Maximum Ratings

(Ta=25°C)

Parameter	Symbol	Ratings	Unit
Supply Voltage	Vcc	6.0	V
Operating Temperature	Topr	-10 ~ +60	°C
Storage Temperature	Tstg	-20 ~ +75	°C
Soldering Temperature *1	Tsol	240	°C

*1 At the position of 2mm from the bottom of the package within 5 seconds.

4. Electro-optical Characteristics

(Ta=25°C)

Parameter	Symbol	Conditions	Min.	Typ.	Max.	Unit
Supply Voltage	Vcc		2.7		5.5	V
Current Consumption	Icc	Input Signal = 0		1.0	1.2	mA
Reception Distance	d	200±5Lux, Vcc=3.0V	10	16		m
Half Angle	Δθh			±45		deg
B.P.F. Center Frequency	Fo			37.9		kHz
Peak Wavelength	λp			940		nm
Signal Output	So		--- Active Low ---			
High Level Output Voltage	Voh		Vcc-0.5			V
Low Level Output Voltage	Vol			0.2	0.4	V
High Level Pulse Width	Twh	Burst Wave = 600μs	500	600	700	μs
Low Level Pulse Width	Twl		500	600	700	μs

5. Reliability Test Items

(Ta=25°C)

Test Items	Test Conditions	Ratings
High Temperature Storage	Ta=60°C, Vcc=3.0V	t=240hr.
Low Temperature Storage	Ta=-10°C, Vcc=3.0V	t=240hr.
High Temperature High Humid Storage	Ta=40°C, 90%RH, Vcc=3.0V	t=240hr.
Temperature Cycling	-20°C (30min) ~ +70°C (30min)	20 cycles
Soldering Heat	240±5°C	5 sec.

SMD Micro Embedded Infrared Receiver Module

Module No.: PIC-9011ATE

Relative Reception Distance vs Transmitter Carrier Frequency

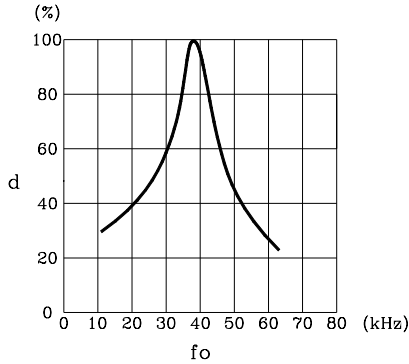

Sensitivity Diagram

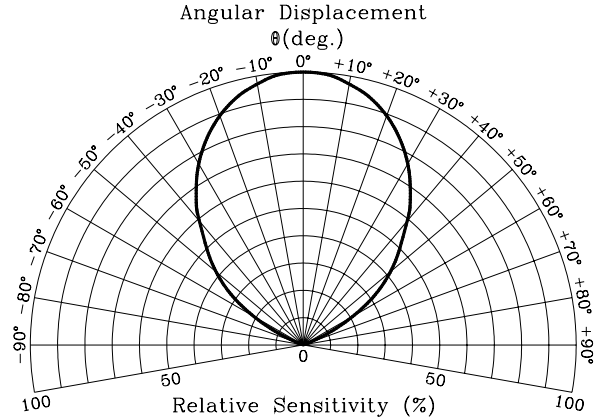

In case of noisy power supply, please serially insert 100Ω resistor and about 47μF electrolytic capacitor in Vcc line and ground as follows:-

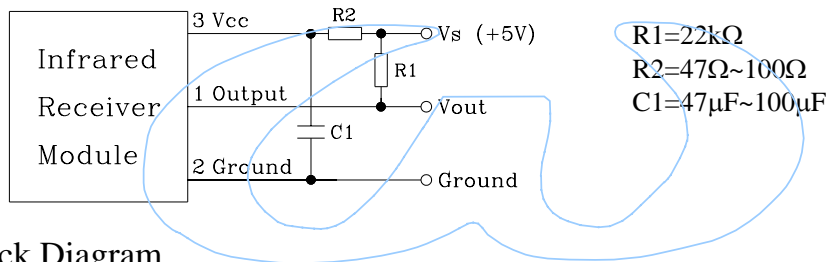

Block Diagram

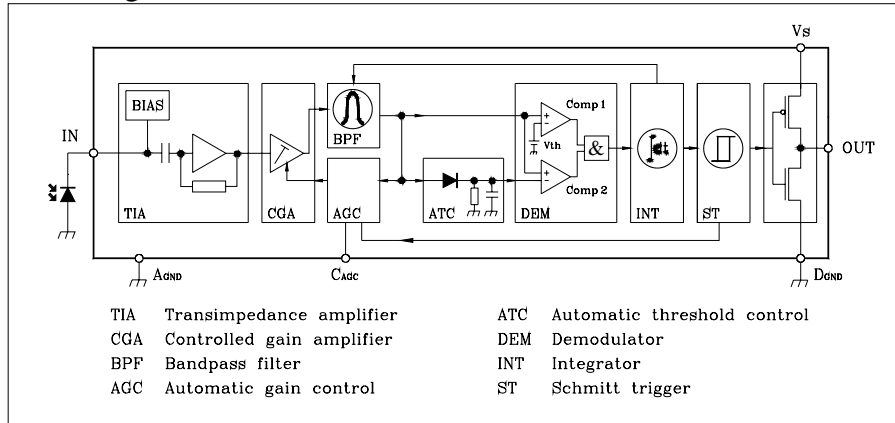

Caution: This device is CMOS design. The signal output port of this device should drive the input port of the next stage device UNILATERALLY. Directly connecting the output port of this device with that of other device is not allowed and will cause the device to be damaged.

Standard Inspection

Among electrical characteristics, total quantity will be inspected as below:-

- ⊙ Distance between emitter and detector
- ⊙ Current consumption
- ⊙ H level output voltage
- ⊙ L level output voltage

SMD Micro Embedded Infrared Receiver Module

Module No.: PIC-9011ATE

Testing Method

Distance between emitter and detector specifies maximum distance that output waveform satisfies the standard (FIG-3) under the conditions below against the standard transmitter.

- Measuring place
Indoor without extreme reflection of light.
- Ambient light source
Detecting surface illumination is $200 \pm 5 \text{Lux}$ under ordinary white fluorescence lamp of no high frequency lightning.

- Standard transmitter
Transmitter wave indicated in FIG-2 of standard transmitter is arranged to satisfy $V_o \geq 50 \text{mVp-p}$ under the measuring circuit specified in FIG-3

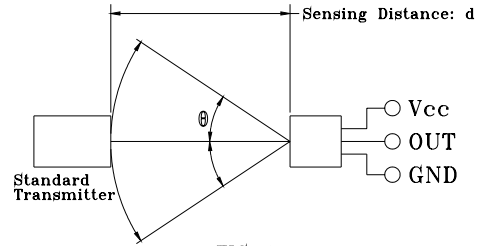
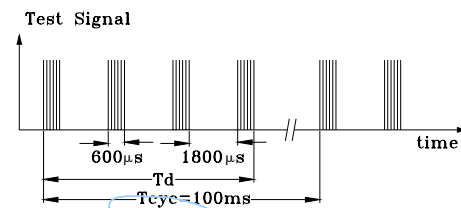

FIG-1



$T_{cyc} - T_d > 30 \text{ms}$ is recommended for optimal function

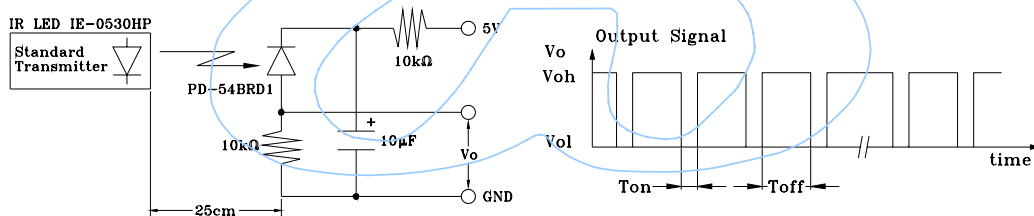
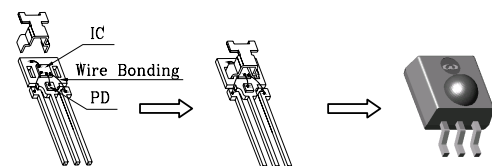

FIG-3 Power Output Measurement Circuit

FIG-2

Embedded Design

This design (Fig-4) is to install a metal case on the carrier lead frame to cover the semiconductor components, in order to shield it electromagnetically within the epoxy resin encapsulation.



Die Bonding Embedded Cover Protection After Encapsulation

FIG-4 Embedded Design

Precautions for Use

- Store and use where there is no force causing transformation or change in quality.
- Store and use where there is no corrosive gas or sea (salt) breeze.
- Store and use where there is no extreme humidity.
- Solder the lead pin within the condition of ratings. After soldering, do not add exterior force.
- Do not wash this device. Wipe the stains of diode side with a soft cloth. You can use the solvent, ethyl alcohol, or methyl alcohol only.
- To prevent static electricity damage to the pre-amp, make sure that the human body, the soldering iron are connected to ground before using.