

Single line IPAD™, EMI filter and ESD protection

Features

- User-customizable filtering solution (recommended use of 2.2 μ H external inductor)
- 8 MHz bandwidth
- Provide very high attenuation at 27 MHz
- Ultra-low stand-by power consumption compared to active filters, ideal for portable applications
- Accurate 75 + 5% impedance matching
- High efficiency in ESD protection (IEC standards)
- High reliability offered by monolithic integration

Complies with the following standards

- IEC 61000-4-2 level 4 on internal and external pins:
 - ± 15 kV (air discharge)
 - ± 8 kV (contact discharge)

Application

- Portable applications with analog TV output

Description

The EMIF01-TV02F3 chip is a highly integrated device designed to suppress EMI and RFI noise in all systems with TV analog output signal subjected to electromagnetic interference.

This filter includes ESD protection circuitry, which prevents damage to the protected device when subjected to ESD surges up to 15 kV.

The EMIF01-TV02F3 provides high anti-aliasing filtering performances to reject frequencies above 8 MHz with high attenuation at 27 MHz when an external inductor of 2.2 μ H is connected between pins B2 and B1.



Figure 1. Pin configuration (bump side)

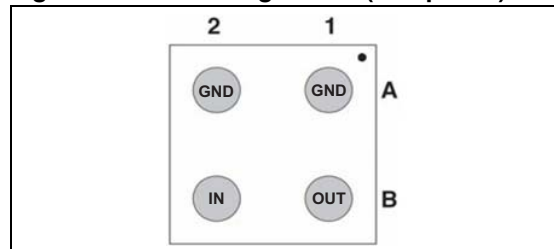
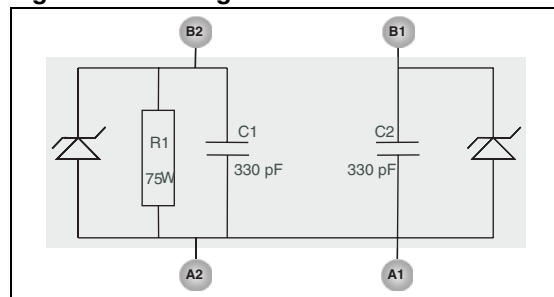

Figure 2. Configuration



TM: IPAD is a trademark of STMicroelectronics.

1 Characteristics

Table 1. Absolute maximum ratings

Symbol	Parameter and test conditions	Value	Unit
V _{PP}	Internal pins (B1) and external pin (B2):		
	ESD discharge IEC 61000-4-2, air discharge	15	kV
	ESD discharge IEC 61000-4-2, contact discharge	15	
T _j	Maximum junction temperature	150	°C
T _{op}	Operating temperature range	-40 to +85	°C
T _{stg}	Storage temperature range	-55 to 150	°C

Table 2. Electrical characteristics (T_{amb} = 25 °C)

Symbol	Parameters								
V _{BR}	Breakdown voltage								
I _{RM}	Leakage current @ V _{RM}								
V _{RM}	Stand-off voltage								
V _{CL}	Clamping voltage								
R _d	Dynamic impedance								
I _{PP}	Peak pulse current								
R _{I/O}	Series resistance between Input and Output								
C _{line}	Input capacitance per line								
Symbol	Test conditions					Min	Typ	Max	Unit
V _{BR}	I _R = 1 mA					6.1		7.9	V
I _{RM}	V _R = 1 mA, between bumps B1 and A1			200	nA				
R1	Tolerance ± 5 %		75		Ω				
C1, C2	V _{line} = 0 V, V _{osc} = 30 mV, F = 1 MHz (measured under zero light conditions) Tolerance: ± 20%		330		pF				

Figure 3. S21 attenuation measurement (typical value)

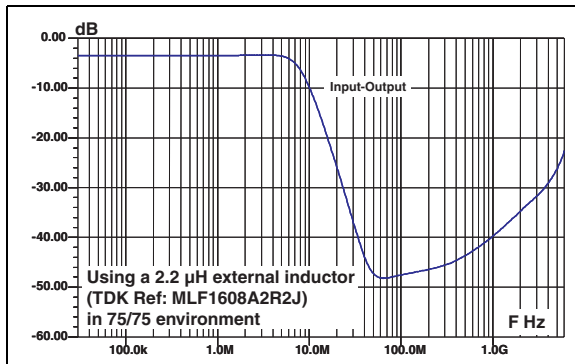

Figure 4. ESD response to IEC 61000-4-2 (+15 kV air discharge) on one input $V_{(in)}$ and on one output $V_{(out)}$

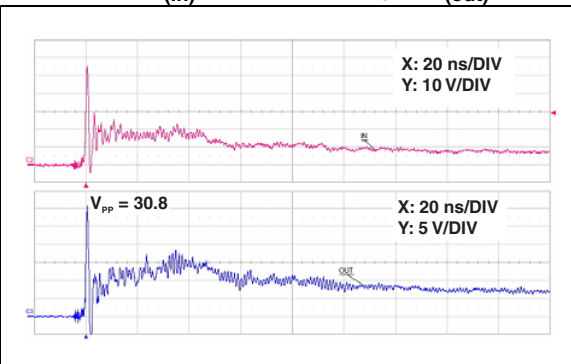
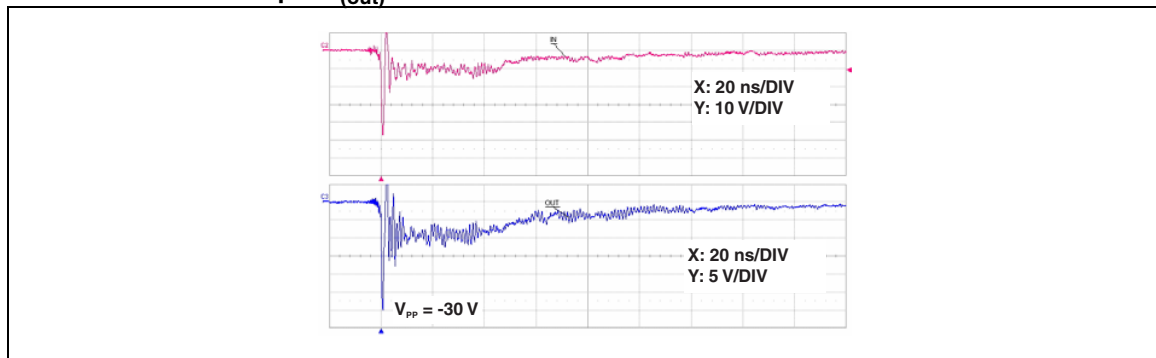
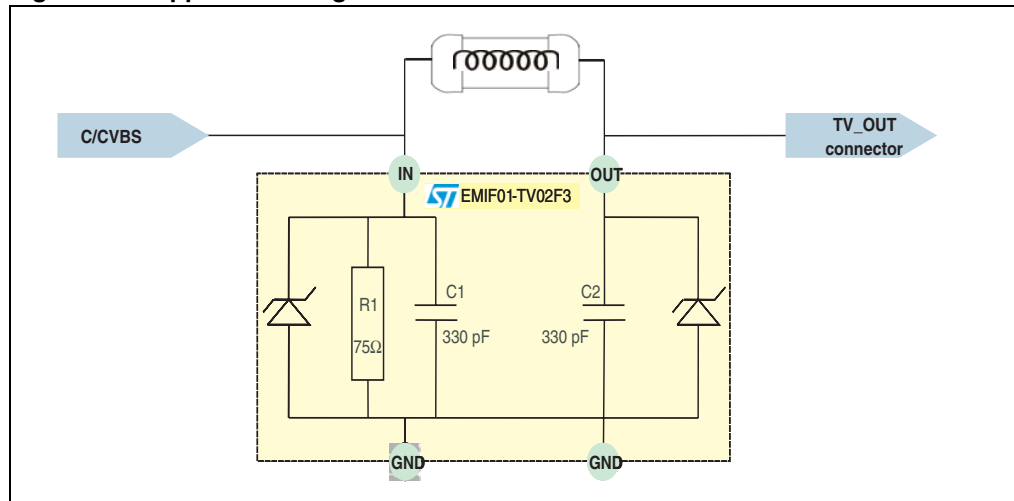

Figure 5. ESD response to IEC 61000-4-2 (-15 kV air discharge) on one input $V_{(in)}$ and on one output $V_{(out)}$



2 Application information

Figure 6. Application diagram



3 Ordering information scheme

Figure 7. Ordering information scheme

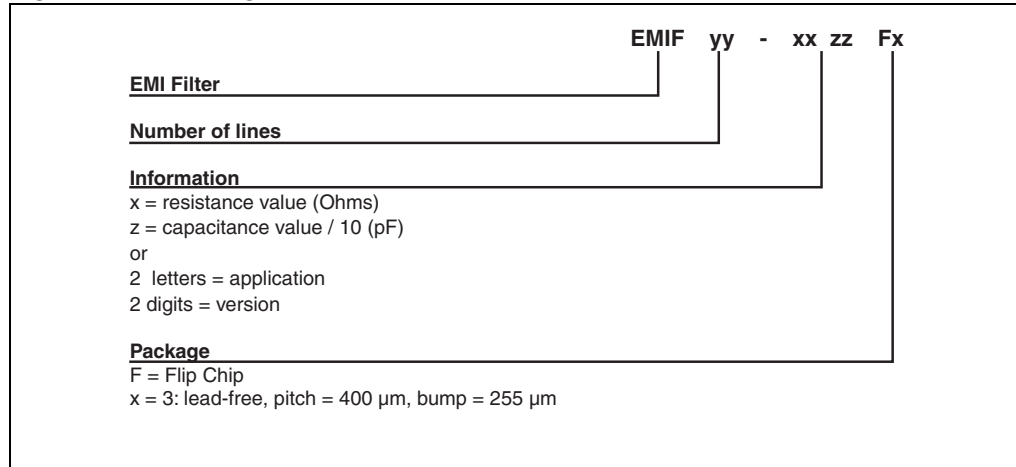

4 Package information

In order to meet environmental requirements, ST offers these devices in different grades of ECOPACK[®] packages, depending on their level of environmental compliance. ECOPACK[®] specifications, grade definitions and product status are available at: www.st.com. ECOPACK[®] is an ST trademark.

Figure 8. Package dimensions

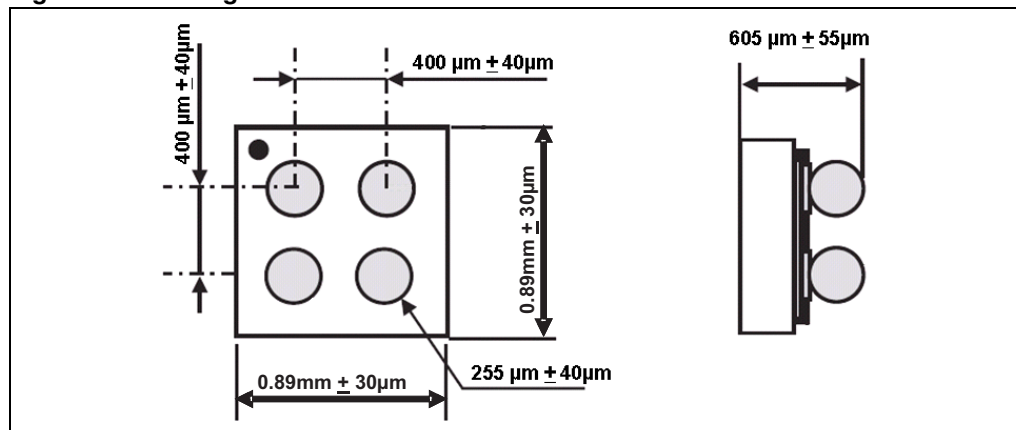

Figure 9. Footprint

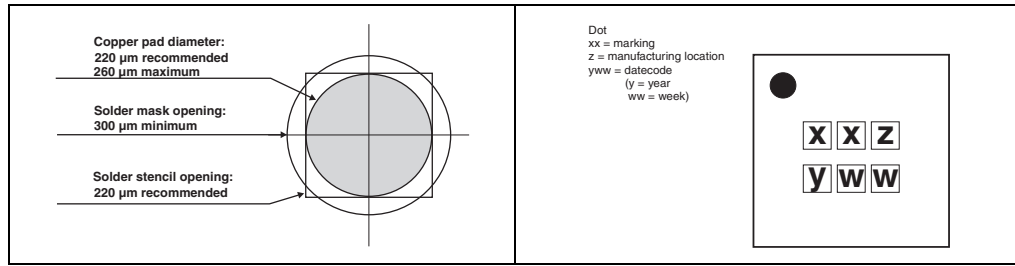

Figure 10. Marking

Dot
xx = marking
z = manufacturing location
yww = datecode
(y = year
ww = week)

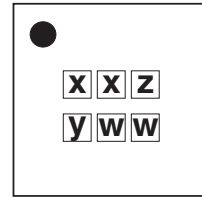
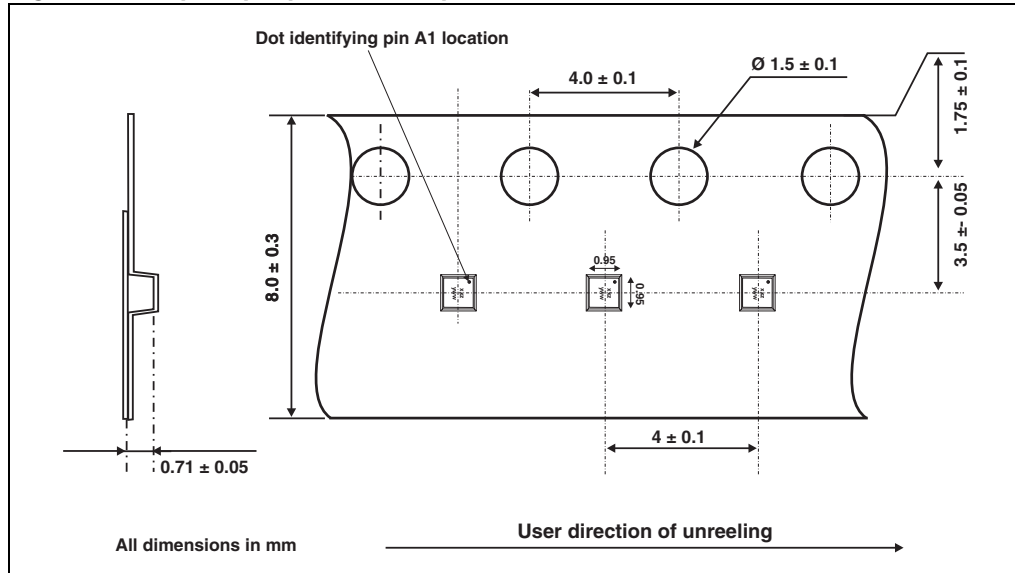

Figure 11. Flip Chip tape and reel specification



5 Ordering information

Table 3. Ordering information

Order code	Marking	Package	Weight	Base qty	Delivery mode
EMIF01-TV02F3	HZ	Flip Chip	1.1 mg	5000	Tape and reel 7"

Note:

More informations are available in the application note:

AN1235: "Flip Chip: Package description and recommendations for use"

AN1751: "EMI filters: Recommendations and measurements"

6 Revision history

Table 4. Document revision history

Date	Revision	Changes
20-Jan-2009	1	Initial release.

Please Read Carefully:

Information in this document is provided solely in connection with ST products. STMicroelectronics NV and its subsidiaries ("ST") reserve the right to make changes, corrections, modifications or improvements, to this document, and the products and services described herein at any time, without notice.

All ST products are sold pursuant to ST's terms and conditions of sale.

Purchasers are solely responsible for the choice, selection and use of the ST products and services described herein, and ST assumes no liability whatsoever relating to the choice, selection or use of the ST products and services described herein.

No license, express or implied, by estoppel or otherwise, to any intellectual property rights is granted under this document. If any part of this document refers to any third party products or services it shall not be deemed a license grant by ST for the use of such third party products or services, or any intellectual property contained therein or considered as a warranty covering the use in any manner whatsoever of such third party products or services or any intellectual property contained therein.

UNLESS OTHERWISE SET FORTH IN ST'S TERMS AND CONDITIONS OF SALE ST DISCLAIMS ANY EXPRESS OR IMPLIED WARRANTY WITH RESPECT TO THE USE AND/OR SALE OF ST PRODUCTS INCLUDING WITHOUT LIMITATION IMPLIED WARRANTIES OF MERCHANTABILITY, FITNESS FOR A PARTICULAR PURPOSE (AND THEIR EQUIVALENTS UNDER THE LAWS OF ANY JURISDICTION), OR INFRINGEMENT OF ANY PATENT, COPYRIGHT OR OTHER INTELLECTUAL PROPERTY RIGHT.

UNLESS EXPRESSLY APPROVED IN WRITING BY AN AUTHORIZED REPRESENTATIVE OF ST, ST PRODUCTS ARE NOT DESIGNED, AUTHORIZED OR WARRANTED FOR USE IN MILITARY, AIR CRAFT, SPACE, LIFE SAVING, OR LIFE SUSTAINING APPLICATIONS, NOR IN PRODUCTS OR SYSTEMS, WHERE FAILURE OR MALFUNCTION MAY RESULT IN PERSONAL INJURY, DEATH, OR SEVERE PROPERTY OR ENVIRONMENTAL DAMAGE. ST PRODUCTS WHICH ARE NOT SPECIFIED AS "AUTOMOTIVE GRADE" MAY ONLY BE USED IN AUTOMOTIVE APPLICATIONS AT USER'S OWN RISK.

Resale of ST products with provisions different from the statements and/or technical features set forth in this document shall immediately void any warranty granted by ST for the ST product or service described herein and shall not create or extend in any manner whatsoever, any liability of ST.

ST and the ST logo are trademarks or registered trademarks of ST in various countries.

Information in this document supersedes and replaces all information previously supplied.

The ST logo is a registered trademark of STMicroelectronics. All other names are the property of their respective owners.

© 2009 STMicroelectronics - All rights reserved

STMicroelectronics group of companies

Australia - Belgium - Brazil - Canada - China - Czech Republic - Finland - France - Germany - Hong Kong - India - Israel - Italy - Japan - Malaysia - Malta - Morocco - Singapore - Spain - Sweden - Switzerland - United Kingdom - United States of America

www.st.com