



Micro Commercial Components

Micro Commercial Components
20736 Marilla Street Chatsworth
CA 91311
Phone: (818) 701-4933
Fax: (818) 701-4939

P6KE6.8 THRU P6KE540(C)A

600WATTS TRANSIENT VOLTAGE SUPPRESSOR 6.8 TO 540 VOLTS

Features

- Economical series
- Available in both unidirectional and bidirectional construction and suffix "C" designates bidirectional type
- Lead Free Finish/Rohs Compliant (Note1) ("P" Suffix designates Compliant. See ordering information)
- 600 watts peak pulse power dissipation and 5.8~459V V_{WM}
- UL Recognized File # E222849

- **CASE:** Molded Plastic. UL Flammability Classification Rating 94V-0
- Moisture Sensitivity: Level 1 per J-STD-020C
- **POLARITY:** Banded denotes cathode. Bidirectional not marked.
- **WEIGHT:** 0.4 Gram (Appx.).
- **MOUNTING POSITION:** Any.

Maximum Ratings

Peak Pulse Power Dissipation at 25°C: 600Watts

Steady State Power Dissipation: 5 Watts at $T_L=75^\circ C$

3/8" Lead Length

$t_{clamping}$ (0 Volts to BV Min.):

Unidirectional $<1 \times 10^{-12}$ Seconds; Bidirectional $<5 \times 10^{-9}$ Seconds.

Operating and Storage Temperature: $-55^\circ C$ to $+175^\circ C$

APPLICATION

Use in sensitive electronics protection against voltage transients induced by inductive load switching and lighting on ICs, MOSFET, signal lines of sensor units for consumer, computer, industrial, automotive and telecommunication.

DO-15

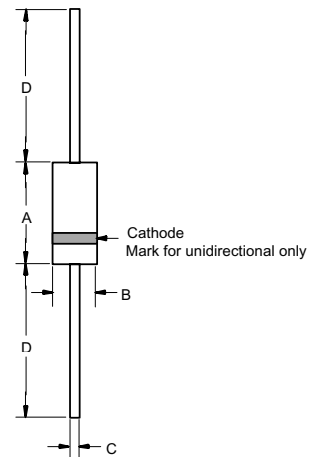

DIM	INCHES		MM		NOTE
	MIN	MAX	MIN	MAX	
A	.230	.300	5.80	7.60	
B	.104	.140	2.60	3.60	
C	.028	.034	.70	.90	
D	1.000	---	25.40	---	

Note: 1. High Temperature Solder Exemptions Applied, see EU Directive Annex 7.

P6KE6.8 thru P6KE540A

RATINGS AND CHARACTERISTICS CURVES

($T_A = 25\text{ }^\circ\text{C}$ unless otherwise noted)

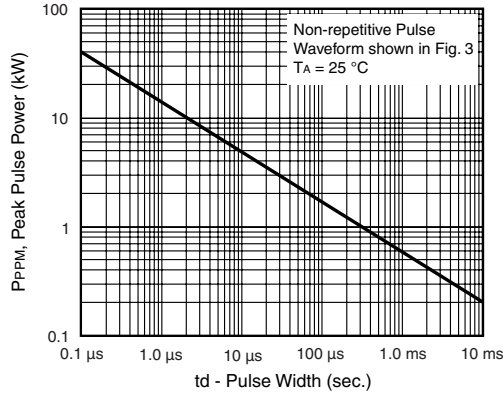

Figure 1. Peak Pulse Power Rating Curve

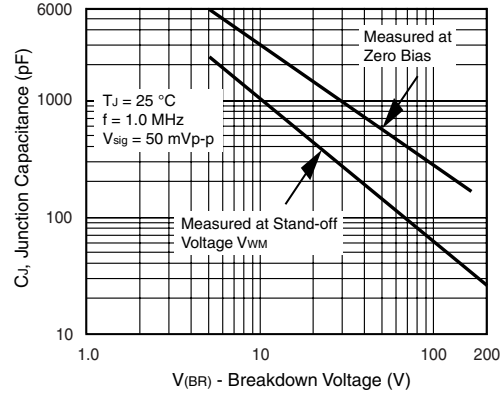

Figure 4. Typical Junction Capacitance Uni-Directional

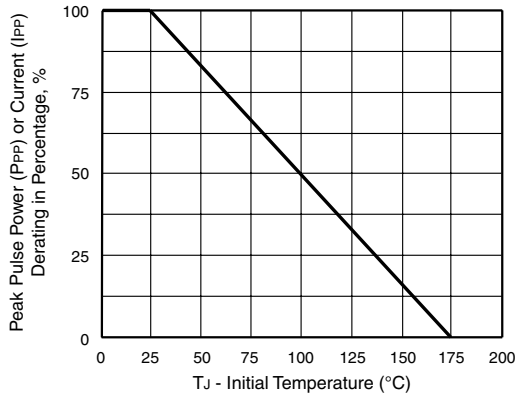

Figure 2. Pulse Power or Current versus Initial Junction Temperature

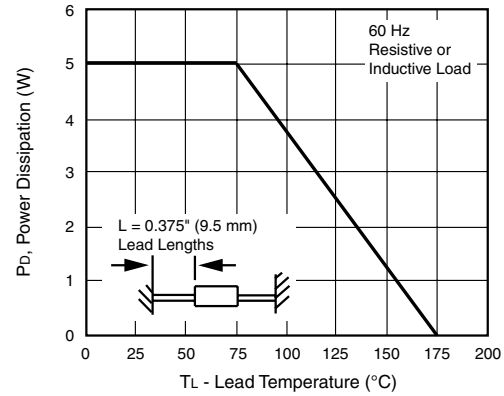

Figure 5. Power Derating Curve

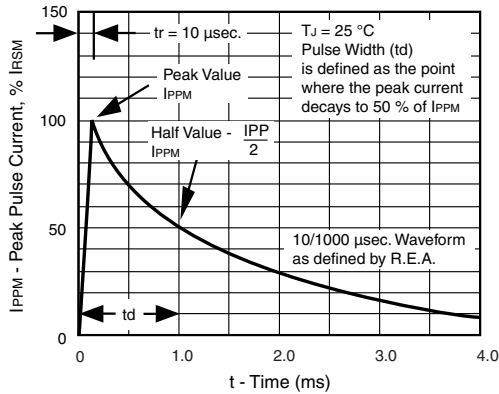

Figure 3. Pulse Waveform

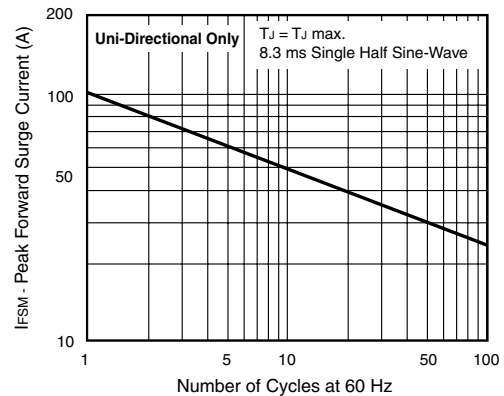

Figure 6. Maximum Non-Repetitive Forward Surge Current

P6KE6.8 thru P6KE540A



Micro Commercial Components

MCC PART NUMBER	BREAKDOWN VOLTAGE V_{BR} @ I_T (VOLTS)			TEST CURRENT I_T mADC	RATED STANDOFF VOLTAGE V_{WM} V	MAXIMUM REVERSE LEAKAGE I_B @ V_{WM} (μ A)	MAXIMUM CLAMPING VOLTAGE V_C @ I_{PP} V	MAXIMUM PEAK PULSE CURRENT I_{PP} A	MAX. TEMP COEFFICIENT OF V_{BR} V_{BR} (TA) -55°C TO 100°C % / °C
	MIN	NOM	MAX						
P6KE6.8	6.12	6.8	7.48	10	5.5	1000	10.8	56	.057
P6KE6.8A	6.45	6.8	7.14	10	5.8	1000	10.5	57	.057
P6KE7.5	6.75	7.5	8.25	10	6.05	500	11.7	51	.061
P6KE7.5A	7.13	7.5	7.88	10	6.4	500	11.3	53	.061
P6KE8.2	7.38	8.2	9.02	10	6.63	200	12.5	48	.065
P6KE8.2A	7.79	8.2	8.61	10	7.02	200	12.1	50	.065
P6KE9.1	8.19	9.1	10	1	7.37	50	13.8	44	.068
P6KE9.1A	8.65	9.1	9.55	1	7.78	50	13.4	45	.068
P6KE10	9.0	10	11	1	8.1	10	15	40	.073
P6KE10A	9.5	10	10.5	1	8.55	10	14.5	41	.073
P6KE11	9.9	11	12.1	1	8.92	5	16.2	37	.075
P6KE11A	10.5	11	11.6	1	9.4	5	15.6	38	.075
P6KE12	10.8	12	13.2	1	9.72	5	17.3	35	.078
P6KE12A	11.4	12	12.6	1	10.2	5	16.7	36	.078
P6KE13	11.7	13	14.3	1	10.5	5	19	32	.081
P6KE13A	12.4	13	13.7	1	11.1	5	18.2	33	.081
P6KE15	13.5	15	16.5	1	12.1	5	22	27	.084
P6KE15A	14.3	15	15.8	1	12.8	5	21.2	28	.084
P6KE16	14.4	16	17.6	1	12.9	5	23.5	26	.086
P6KE16A	15.2	16	16.8	1	13.6	5	22.5	27	.086
P6KE18	16.2	18	19.8	1	14.5	5	26.5	23	.088
P6KE18A	17.1	18	18.9	1	15.3	5	25.2	24	.088
P6KE20	18	20	22	1	16.2	5	29.1	21	.090
P6KE20A	19	20	21	1	17.1	5	27.7	22	.090
P6KE22	19.8	22	24.2	1	17.8	5	31.9	19	.092
P6KE22A	20.9	22	23.1	1	18.8	5	30.6	20	.092
P6KE24	21.6	24	26.4	1	19.4	5	34.7	17	.094
P6KE24A	22.8	24	25.2	1	20.5	5	33.2	18	.094
P6KE27	24.3	27	29.7	1	21.8	5	39.1	15	.096
P6KE27A	25.7	27	28.4	1	23.1	5	37.5	16	.096
P6KE30	27	30	33	1	24.3	5	43.5	14	.097
P6KE30A	28.5	30	31.5	1	25.6	5	41.4	14.4	.097
P6KE33	29.7	33	36.3	1	26.8	5	47.7	12.6	.098
P6KE33A	31.4	33	34.7	1	28.2	5	45.7	13.2	.098
P6KE36	32.4	36	39.6	1	29.1	5	52	11.6	.099
P6KE36A	34.2	36	37.8	1	30.8	5	49.9	12	.099
P6KE39	35.1	39	42.9	1	31.6	5	56.4	10.6	.100
P6KE39A	37.1	39	41	1	33.3	5	53.9	11.2	.100
P6KE43	38.7	43	47.3	1	34.8	5	61.9	9.6	.101
P6KE43A	40.9	43	45.2	1	36.8	5	59.3	10.1	.101
P6KE47	42.3	47	51.7	1	38.1	5	67.8	8.9	.101
P6KE47A	44.7	47	49.4	1	40.2	5	64.8	9.3	.101
P6KE51	45.9	51	56.1	1	41.3	5	73.5	8.2	.102
P6KE51A	48.5	51	53.6	1	43.6	5	70.1	8.6	.102
P6KE56	50.4	56	61.6	1	45.4	5	80.5	7.4	.103
P6KE56A	53.2	56	58.8	1	47.8	5	77	7.8	.103
P6KE62	55.8	62	68.2	1	50.2	5	89	6.8	.104
P6KE62A	58.9	62	65.1	1	53	5	85	7.1	.104
P6KE68	61.2	68	74.8	1	55.1	5	98	6.1	.104
P6KE68A	64.6	68	71.4	1	58.1	5	92	6.5	.104

P6KE6.8 thru P6KE540A

MCC PART NUMBER	BREAKDOWN VOLTAGE $V_{(BR)} @ I_T$ (VOLTS)			TEST CURRENT I_T mADC	RATED STANDOFF VOLTAGE V_{WM} V	MAXIMUM REVERSE LEAKAGE $I_D @ V_{WM}$ (μ A)	MAXIMUM CLAMPING VOLTAGE $V_C @ I_{PP}$ V	MAXIMUM PEAK PULSE CURRENT I_{PP} A	MAX. TEMP COEFFICIENT OF V_{BR} $V_{(BR)} (TA)$ -55°C TO 100°C % / °C
	MIN	NOM	MAX						
P6KE75	67.5	75	82.5	1	60.7	5	108	5.5	.105
P6KE75A	71.3	75	78.8	1	64.1	5	103	5.8	.105
P6KE82	73.8	82	90.2	1	66.4	5	118	5.1	.105
P6KE82A	77.9	82	86.1	1	70.1	5	113	5.3	.105
P6KE91	81.9	91	100	1	73.7	5	131	4.5	.106
P6KE91A	86.5	91	95.5	1	77.8	5	125	4.8	.106
P6KE100	90	100	110	1	81	5	144	4.2	.106
P6KE100A	95	100	105	1	85.5	5	137	4.4	.106
P6KE110	99	110	121	1	89.2	5	158	3.8	.107
P6KE110A	105	110	116	1	94	5	152	4.0	.107
P6KE120	108	120	132	1	97.2	5	173	3.5	.107
P6KE120A	114	120	126	1	102	5	165	3.6	.107
P6KE130	117	130	143	1	105	5	187	3.2	.108
P6KE130A	124	130	137	1	111	5	179	3.3	.108
P6KE150	135	150	165	1	121	5	215	2.8	.108
P6KE150A	143	150	158	1	128	5	207	2.9	.108
P6KE160	144	160	176	1	130	5	230	2.6	.108
P6KE160A	152	160	168	1	136	5	219	2.7	.108
P6KE170	153	170	187	1	138	5	244	2.5	.108
P6KE170A	161	170	179	1	145	5	234	2.6	.108
P6KE180	162	180	198	1	146	5	258	2.3	.108
P6KE180A	171	180	189	1	154	5	246	2.4	.108
P6KE200	180	200	220	1	162	5	287	2.1	.108
P6KE200A	190	200	210	1	171	5	274	2.2	.108
P6KE220	198	220	242	1	175	5	344	1.8	.108
P6KE220A	209	220	231	1	185	5	328	1.9	.108
P6KE250	225	250	275	1	202	5	360	1.7	.110
P6KE250A	237	250	263	1	214	5	344	1.8	.110
P6KE300	270	300	330	1	243	5	430	1.4	.110
P6KE300A	285	300	315	1	256	5	414	1.5	.110
P6KE350	315	350	385	1	284	5	504	1.2	.110
P6KE350A	332	350	368	1	300	5	482	1.3	.110
P6KE400	360	400	440	1	324	5	574	1.05	.110
P6KE400A	380	400	420	1	342	5	548	1.1	.110
P6KE440	396	440	484	1	356	5	631	0.99	.110
P6KE440A	418	440	462	1	376	5	600	1.04	.110
P6KE480	432	480	528	1	389	5	686	0.88	.110
P6KE480A	456	480	504	1	408	5	658	0.91	.110
P6KE510	459	510	561	1	413	5	729	0.82	.110
P6KE510A	485	510	535	1	434	5	698	0.86	.110
P6KE540	486	510	594	1	437	5	772	0.78	.110
P6KE540A	513	510	567	1	459	5	740	0.81	.110

Notes: For bidirectional types having V_{wm} of 10 Volts and less, the I_T limit is double.
For parts without A, the V_{BR} is +/- 10%.



Micro Commercial Components

Ordering Information

Device	Packing
(Part Number)-TP	Tape&Reel; 4Kpcs/Reel
(Part Number)-AP	Ammo Packing;3Kpcs/AmmoBox
(Part Number)-BP	Bulk;500pcs/Box

IMPORTANT NOTICE

Micro Commercial Components Corp. reserves the right to make changes without further notice to any product herein to make corrections, modifications, enhancements, improvements, or other changes. *Micro Commercial Components Corp.* does not assume any liability arising out of the application or use of any product described herein; neither does it convey any license under its patent rights, nor the rights of others. The user of products in such applications shall assume all risks of such use and will agree to hold *Micro Commercial Components Corp.* and all the companies whose products are represented on our website, harmless against all damages.

APPLICATIONS DISCLAIMER

Products offer by *Micro Commercial Components Corp.* are not intended for use in Medical, Aerospace or Military Applications.