

DATA SHEET

SA9502

**Dual-band, CDMA/AMPS
downconverter IC**

Product specification
Supersedes data of 1998 Dec 10
IC17 Data Handbook

1999 Mar 19

Dual-band, CDMA/AMPS downconverter IC

SA9502

DESCRIPTION

The SA9502 integrates all the front end receive mixers necessary for use in dual-band, triple-mode CDMA/AMPS cellular phone handsets. There are three individual mixer blocks, each optimised for high linearity with low power consumption for operation in one of the following modes: High-band 1900MHz PCS CDMA, low-band 800MHz cellular CDMA or analog FM AMPS/TACS modes. Additionally, the entire circuit can be powered down and put into sleep mode, reducing the supply current to typically 12 μ A. The circuit has been designed in our advanced QUBiC2 BiCMOS process with 20GHz f_T .

FEATURES

- PCS and cellular downconverter mixers typical performance:
 - PCS: Gain=11.1dB, NF=8.4dB, IIP3= +1.8dBm
 - CDMA: Gain=11.3dB, NF=9.4dB, IIP3= +5.7dBm
 - FM: Gain= 7.5dB, NF=10.5dB, IIP3= +6.2dBm
- Separate, selectable IF outputs to suit FM and CDMA bandwidths
- PCS mixer LO: direct or via internal frequency doubler

- Switchable wideband LO output buffer
- Low voltage operation down to 2.7V
- Low current consumption in "idle"/receive modes:
 - PCS : 14.3mA @ 2.7V
 - CDMA: 17.6mA @ 2.7V
 - FM: 6.8mA @ 2.7V
- Low standby current in sleep mode, typically 12 μ A
- TSSOP20 package

APPLICATIONS

- 800MHz analog FM and CDMA digital receivers
- 1900MHz PCS band CDMA digital receivers
- Supports dual-mode and triple-mode operation
- Digital mobile communications equipment
- Portable, low power radio equipment

ORDERING INFORMATION

EXTENDED TYPE NUMBER	PACKAGE			
	PINS	PIN POSITION	MATERIAL	CODE
SA9502DH	20	TSSOP	Plastic thin shrink small outline package; body 6.5 x 4.4 x 1.1 mm	SOT360-1

Dual-band, CDMA/AMPS downconverter IC

SA9502

BLOCK DIAGRAM

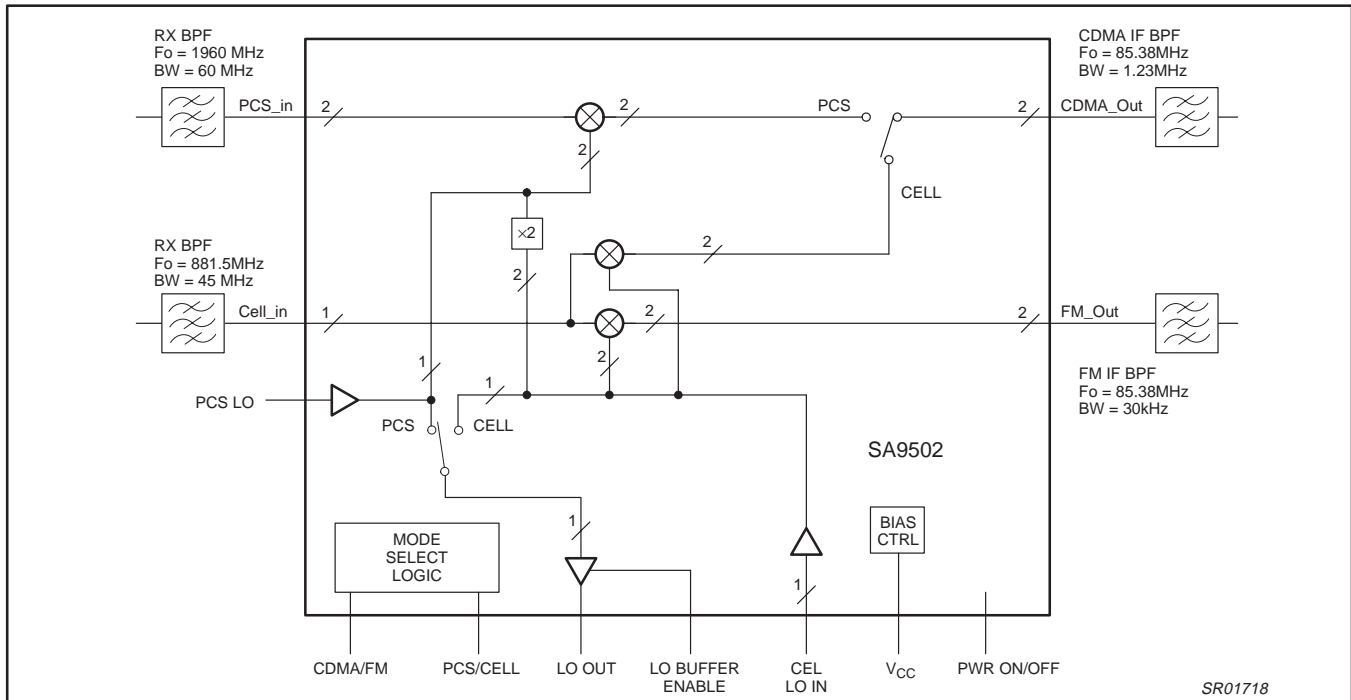

Figure 1. Block Diagram

Table 1. Mode Selection Summary

PCS/CEL (Pin 6)	CDMA/FM/LO doubler (Pin 17)	MODE
low	low	Cellular FM
low	high	Cellular CDMA
high	low	CDMA PCS, direct LO in
high	high	CDMA PCS, LO via frequency doubler

Dual-band, CDMA/AMPS downconverter IC

SA9502

PIN CONFIGURATION

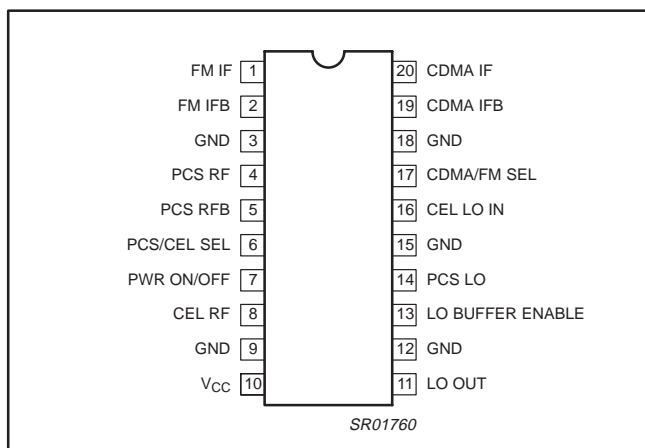

Figure 2. Pin Configuration

PIN DESCRIPTION

PIN	SYMBOL	DESCRIPTION
1	FM IF	Non-inverting FM IF output
2	FM IFB	Inverting FM IF output
3	GND	Analog ground
4	PCS RF	non-inverting PCS RF input
5	PCS RFB	Inverting PCS RF input
6	PCS/CEL SEL	PCS and cellular band select
7	PWR ON/OFF	Power enable
8	CEL RF	Cellular RF input
9	GND	Ground
10	V _{CC}	Power supply
11	LO OUT	LO output to synthesizer
12	GND	Ground
13	LO BUFFER ENABLE	Logic signal which switches the LO buffer output ON or OFF
14	PCS LO	PCS mixer direct LO input
15	GND	Ground
16	CEL LO	Cellular LO input
17	CDMA/FM SEL	CDMA and FM mode select in cellular band; LO direct or via frequency doubler in PCS mode
18	GND	Ground
19	CDMA IFB	Inverting CDMA IF output
20	CDMA IF	Non-inverting CDMA IF output

FUNCTIONAL DESCRIPTION

Mode Selection Logic

The SA9502 downconverter IC has several modes of operation for which the selection logic is summarized in Table 1 and defined in detail in Table 2. Different mode selections require different portions of the circuit to be active. It should be noted that only the states specified in Table 2 are valid selections for operation.

Local Oscillator Section

Local oscillator drive for the mixers is provided through single ended inputs on either pin 16 (CEL LO) or pin 14 (PCS LO). The LO signal has to be AC-coupled into the circuit and needs to be externally matched. Inside the circuit, the cellular band LO signal is amplified and buffered to drive: Either the cellular CDMA mixer or FM mixer or the frequency doubler for the PCS mixer LO and additionally the LO output buffer. The mode selection summary in Table 1 shows the logic to apply to pins 6 and 17 to choose one of four possible modes. The LO output buffer can be programmed on or off via LO Buffer Enable (Pin 13). The LO output buffer's frequency is the same as that used by the mixers.

Cellular and PCS Mixers

The SA9502 has one single ended cellular band RF input which feeds either the cellular CDMA mixer or the cellular FM mixer circuits. Each mixer is optimized to meet cellular band CDMA or analog FM requirements. The cellular FM mixer has its own dedicated differential output on pins 1 and 2 which should to be externally matched to the FM IF SAW filter. The cellular CDMA mixer shares the same output pins with the CDMA PCS mixer. Selection between these two mixers is via pin 6 (PCS/CEL) and as the two mixers are never on at the same time, it allows a common CDMA SAW filter to be used for both bands. The CDMA PCS mixer has a differential RF input which should be used with an external balun matching circuit. To avoid upsetting the internal biasing, the RF inputs at both cellular and PCS band mixers should be AC-coupled in. The CDMA and FM IF mixer outputs are of the open collector type. So, they should be biased to the supply voltage V_{CC} with external tuning inductors which can also serve in the matching of the IF SAW filter.

Dual-band, CDMA/AMPS downconverter IC

SA9502

ABSOLUTE MAXIMUM RATINGS

PARAMETER	RATINGS	UNITS
Supply voltage (V_{CC})	-0.3 to +6.0	V
Logic input voltage	-0.3 to $V_{CC}+0.3$	V
Maximum power input	+20	dBm
Power dissipation, $T_{amb}=25^{\circ}\text{C}$	800	mW
Maximum operating junction temperature	150	$^{\circ}\text{C}$
Storage temperature	-65 to +150	$^{\circ}\text{C}$

RECOMMENDED OPERATING CONDITIONS

PARAMETER	TEST CONDITIONS	LIMITS			UNITS
		MIN.	TYP.	MAX.	
Supply voltage (V_{CC})		2.7	3.0	4.0	V
Logic input voltage range	LOW	-0.3		$0.2V_{CC}$	V
	HIGH	$0.5V_{CC}$		$V_{CC}+0.3$	V
Operating ambient temperature range (T_{amb})		-30		+85	$^{\circ}\text{C}$
Operating junction temperature range		0		105	$^{\circ}\text{C}$

MODE SELECT LOGIC AND DC CHARACTERISTICS

Table 2. Mode Logic Definition

 $V_{CC} = 2.7\text{ V to }4.0\text{ V}$; $T_{amb} = -30^{\circ}\text{C to }+85^{\circ}\text{C}$, unless specified otherwise.

MODE	MODE DESCRIPTION	LO BUFFER ENABLE	POWER ON/OFF	PCS/CEL	CDMA/FM	TYPICAL CURRENT CONSUMPTION @ $V_{CC} = 2.7\text{ V}$	MAXIMUM CURRENT CONSUMPTION	FIGURE
1	PCS RxTx (with doubled LO)	high	high	high	high	27.3 mA	33 mA	3
2	PCS Idle (with doubled LO)	low	high	high	high	18.4 mA	22 mA	4
3	PCS RxTx (with direct LO)	high	high	high	low	23.3 mA	28 mA	5
4	PCS Rx Idle (with direct LO)	low	high	high	low	14.3 mA	17 mA	6
5	Cellular CDMA RxTx	high	high	low	high	23.2 mA	28.5 mA	7
6	Cellular CDMA Rx Idle	low	high	low	high	17.6 mA	21.0 mA	8
7	Cellular FM RxTx	high	high	low	low	11.9 mA	15.5 mA	9
8	Cellular FM Rx Idle	low	high	low	low	6.8 mA	7.8 mA	10
9	Sleep	x	low	x	x	12 μA	50 μA	

NOTE:

x = Don't care

Dual-band, CDMA/AMPS downconverter IC

SA9502

AC ELECTRICAL CHARACTERISTICS $V_{CC} = 2.7V$; $T_{amb} = +25^{\circ}C$; $P_{Io} = -3$ dBm, $f_{IF} = 85.40$ MHz and measured on Philips demonstration board; unless specified otherwise.

PARAMETER	TEST CONDITIONS						UNITS
		MIN.	-3 σ	TYP.	+3 σ	MAX.	
Cellular Band Downconverter							
RF input frequency range		869				894	MHz
LO input frequency range		950				1030	MHz
IF output frequency range (CDMA)		50				300	MHz
IF output frequency range (FM)		50				300	MHz
IF output load impedance	CDMA, differential			1000			Ω
	FM, single-ended, with ext. balun			850			Ω
Conversion gain	CDMA		10.7	11.3	11.9		dB
	FM		7.0	7.5	8.0		dB
Noise figure	CDMA mode, SSB			9.4	10.0		dB
	FM mode, SSB			10.5	10.7		dB
Input IP3	CDMA mode, tone spacing = 900 kHz and 1.7 MHz		4.8	5.7			dBm
	FM mode, tone spacing = 60 kHz		5.3	6.2			dBm
RF input return loss	$Z_S = 50\Omega$			11.0			dB
LO input return loss	$Z_S = 50\Omega$			10.0			dB
LO output return loss	$Z_S = 50\Omega$			8.0			dB
LO input power range		-6.0		-3.0		0.0	dBm
LO output power range	$Z_L = 50\Omega$, single LO out with LO buffer on (Pin 13 = High)		-7.5	-5.0	-3.0		dBm
LO (input and output) to RF leakage	Single-ended in, single-ended out			-34.5	-31.5		dBm
LO (output) to IF leakage (CDMA)	Single-ended in, differential out			-33.6	-29.0		dBm
LO (output) to IF leakage (FM)	Single-ended in, differential out			-20.0	-17.5		dBm
LO (input) to IF leakage (CDMA)	Single-ended in, differential out			-27.7	-26.5		dBm
LO (input) to IF leakage (FM)	Single-ended in, differential out			-18.5	-17.8		dBm
RF to LO (input) isolation	Single-ended in, single-ended out		30	32.8			dB
RF to IF isolation (CDMA)	Single-ended in, differential out		17	17.7			dB
RF to IF isolation (FM)	Single-ended in, differential out		6	8.2			dB
LO output to LO input isolation	Single-ended in, single-ended out		26.5	33			dB
Spurious response rejection (CDMA mode)	With Tx band interferer at LO input port or LO buffer output port of -40 dBm max and with $P_{int} = -31$ dBm in Rx band.		43	44			dB
	With Tx band interferer at RF input port of -40 dBm max and with $P_{int} = -31$ dBm in Rx band.		59	61			dB
Spurious response rejection (FM mode)	With Tx band interferer at LO input port or LO buffer output port of -40 dBm max and with $P_{int} = -31$ dBm in Rx band.		43	44			dB
	With Tx band interferer at RF input port of -40 dBm max and with $P_{int} = -31$ dBm in Rx band.		55	56			dB

Dual-band, CDMA/AMPS downconverter IC

SA9502

AC ELECTRICAL CHARACTERISTICS (continued) $V_{CC} = 2.7V$; $T_{amb} = +25^{\circ}C$; $P_{Io} = -3$ dBm, $f_{IF} = 85.40$ MHz and measured on Philips demonstration board; unless specified otherwise.

PARAMETER	TEST CONDITIONS						UNITS
		MIN	-3 σ	TYP.	+3 σ	MAX.	
PCS Downconverter							
RF input frequency range		1810				1990	MHz
LO input frequency range	With doubler	860				1050	MHz
	Direct PCS LO	1720				2200	MHz
IF output frequency range		50				300	MHz
IF output load impedance	Differential			1000			Ω
Conversion gain	@ f_{IF} , over RF/LO frequency ranges		10.5	11.1	11.7		dB
Noise figure	@ f_{IF} , over RF/LO frequency ranges, SSB			8.4	9.3		dB
Input IP3	@ f_{IF} , over RF/LO frequency ranges at $25^{\circ}C$ @ $V_{CC} = 3.6V$	direct LO		0.5	1.8		dBm
		doubled LO		0.1	1.2		dBm
RF input return loss	$Z_S = 50\Omega$, with external balun			7.5			dB
LO input return loss	$Z_S = 50\Omega$			10			dB
LO output return loss	$Z_S = 50\Omega$, single LO out			8			dB
LO input power range		-6		-3		0	dBm
LO output power range	$Z_L = 50\Omega$, single LO out with LO buffer on (Pin 13 = High)		-10.0	-8.5	-7		dBm
LO (input and output) to RF leakage	Single-ended in, single-ended out, with and without doubler			-56	-47		dBm
LO (input and output) to IF leakage	Single-ended in, differential out, with and without doubler			-43	-39		dBm
RF to LO (input) isolation	Single-ended in, single-ended out, with and without doubler		44	46			dB
RF to IF isolation	Single-ended in, differential out		32	40			dB
LO output to LO input isolation	Single-ended in, single-ended out, with doubler		30	31			dB
1/2 IF spurious rejection	1/2 IF spur, $f_{IF} = 85.4$ MHz/111.38 MHz, with doubler, $P_{int} = -30$ dBm at RF input.		42	46			dB
	1/2 IF spur, $f_{IF} = 85.4$ MHz/111.38 MHz, without doubler, $P_{int} = -30$ dBm at RF input.		68	76			dB
Spurious response rejection	With Tx band interferer at LO input port or LO buffer output port of -40 dBm max and with $P_{int} = -21$ dBm in Rx band.		43	44			dB
	With Tx band interferer at RF input port of -40 dBm max and with $P_{int} = -21$ dBm in Rx band.	direct LO		59	64		dB
		doubled LO		53	61		dB

Dual-band, CDMA/AMPS downconverter IC

SA9502

PERFORMANCE CHARACTERISTICS

DC Current Consumption

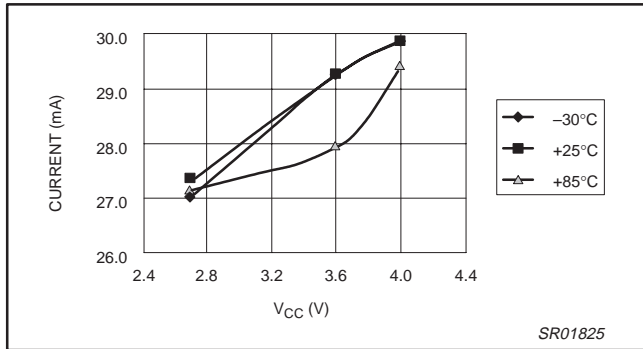

Figure 3. PCS RxTx (with doubled LO out) current

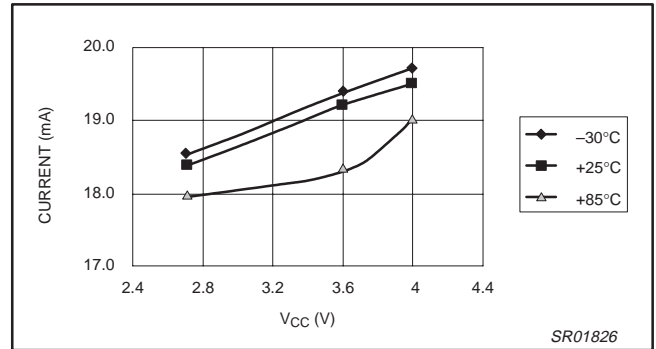

Figure 4. PCS Idle (with doubled LO out) current

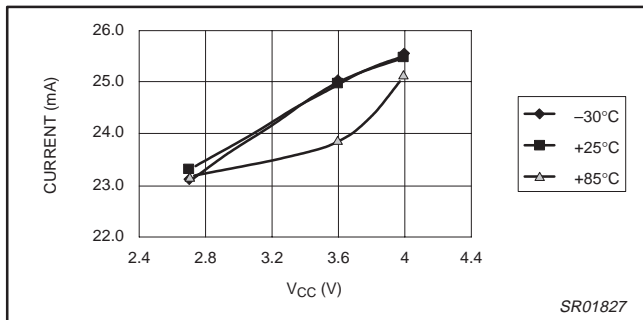

Figure 5. PCS RxTx current

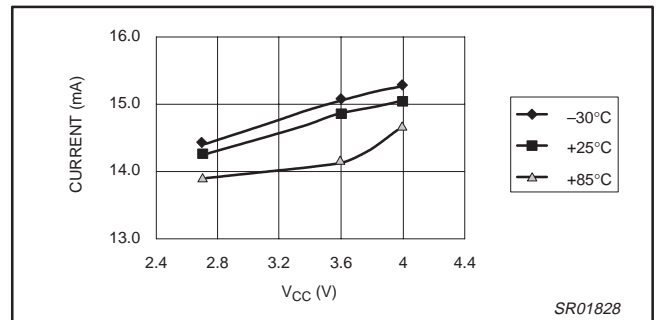

Figure 6. PCS Rx Idle current

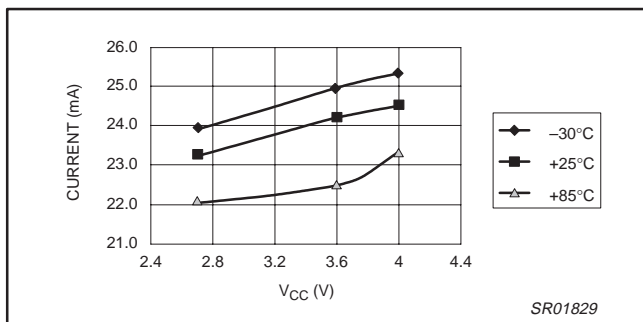

Figure 7. Cellular CDMA RxTx current

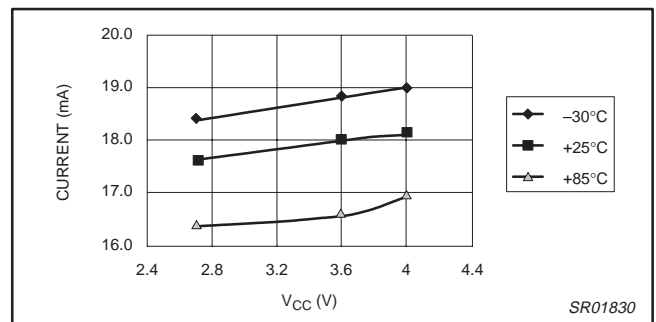

Figure 8. Cellular CDMA Rx Idle current

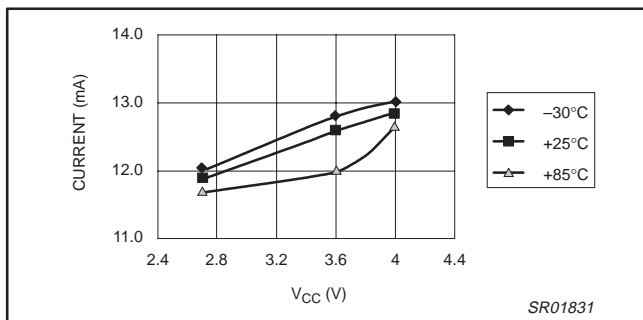

Figure 9. Cellular FM RxTx current

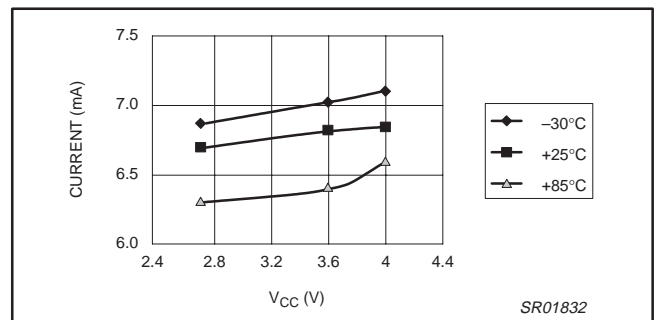

Figure 10. Cellular FM Rx Idle current

Dual-band, CDMA/AMPS downconverter IC

SA9502

PERFORMANCE CHARACTERISTICS

Mixer Noise Figure

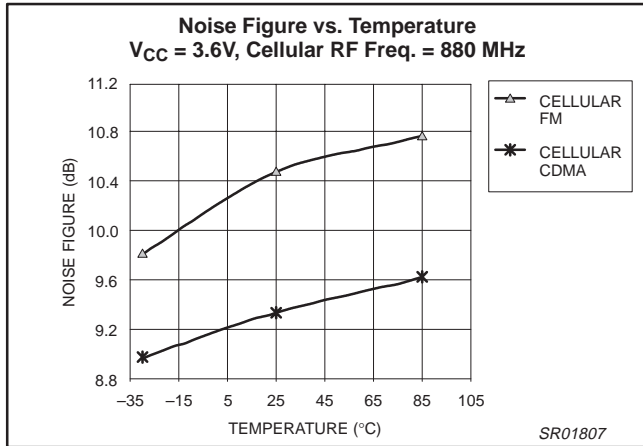

Figure 11.

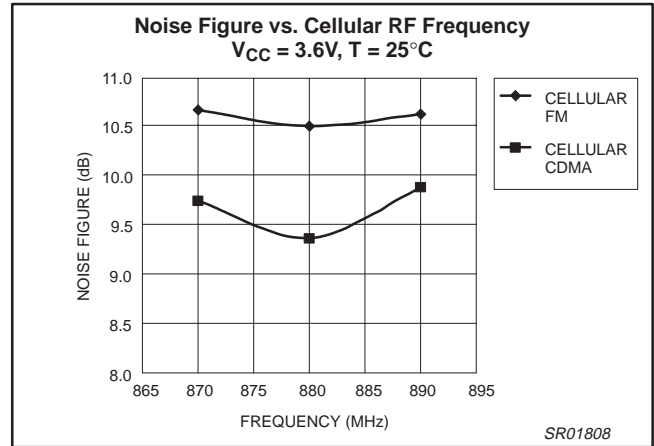

Figure 12.

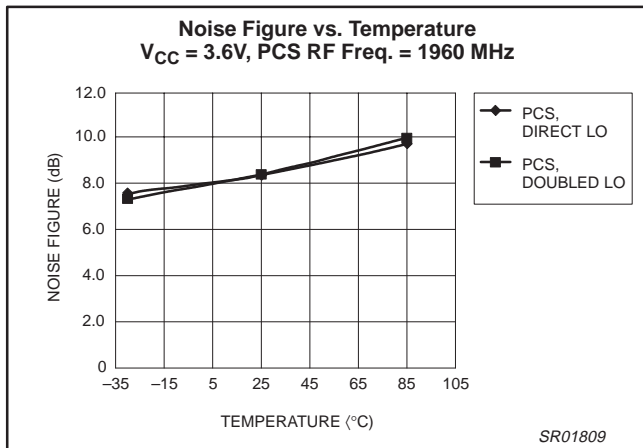

Figure 13.

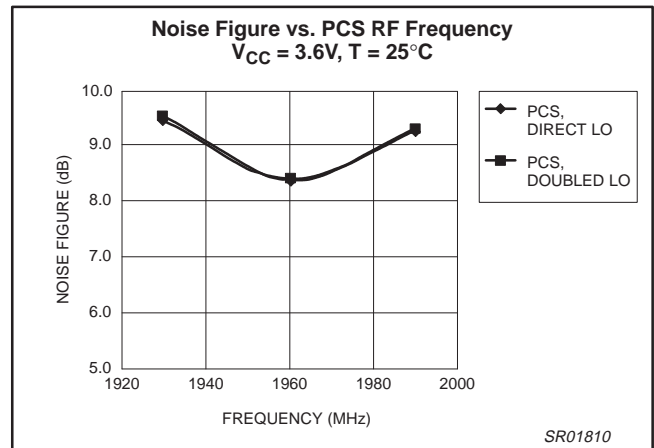

Figure 14.

Dual-band, CDMA/AMPS downconverter IC

SA9502

PERFORMANCE CHARACTERISTICS

Conversion Gain – FM Mixer

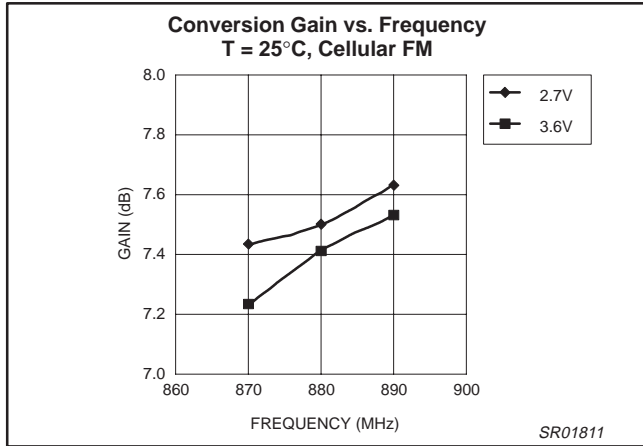

Figure 15.

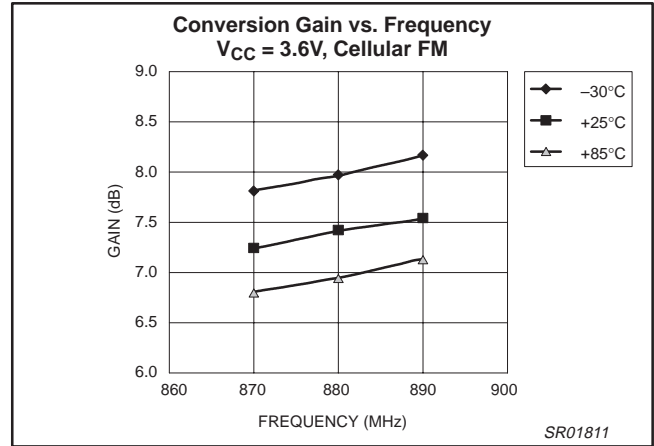

Figure 16.

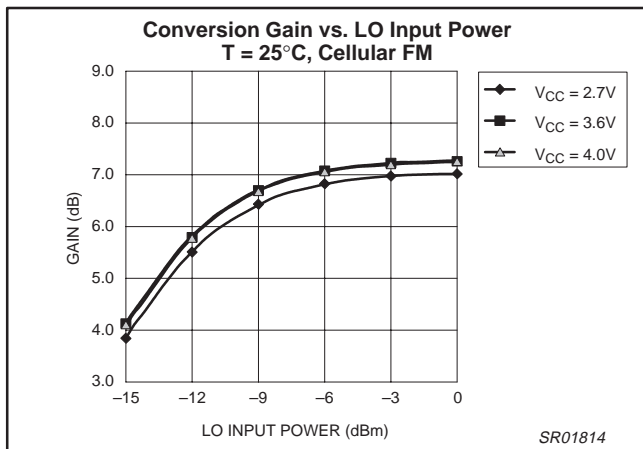

Figure 17.

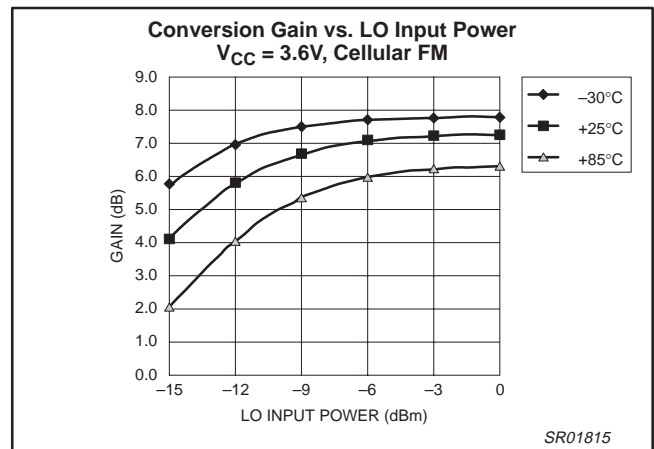

Figure 18.

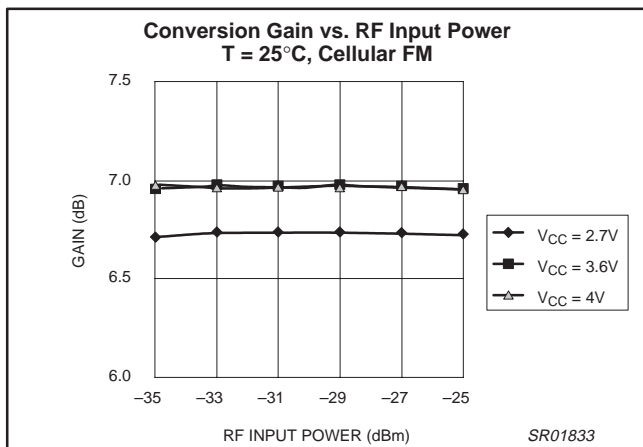

Figure 19.

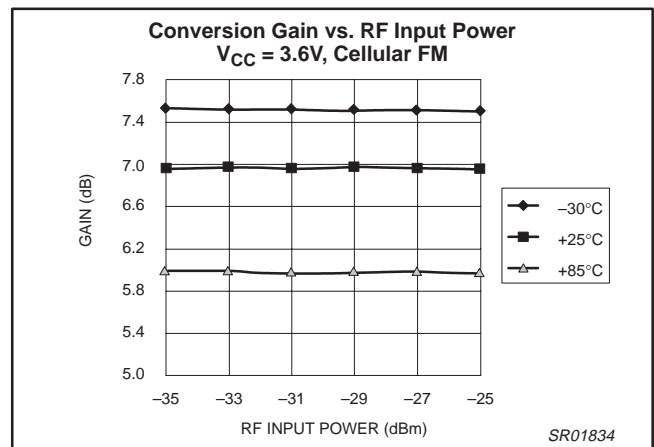

Figure 20.

Dual-band, CDMA/AMPS downconverter IC

SA9502

PERFORMANCE CHARACTERISTICS

Conversion Gain – Cellular Band CDMA Mixer

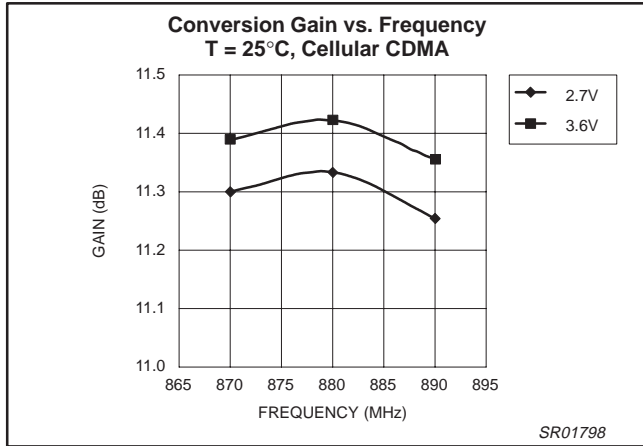

Figure 21.

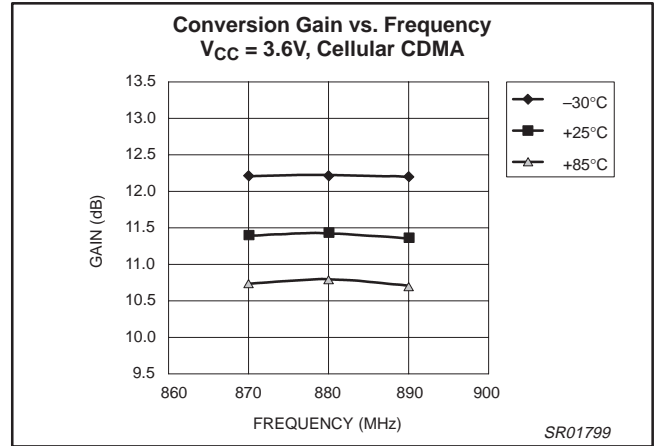

Figure 22.

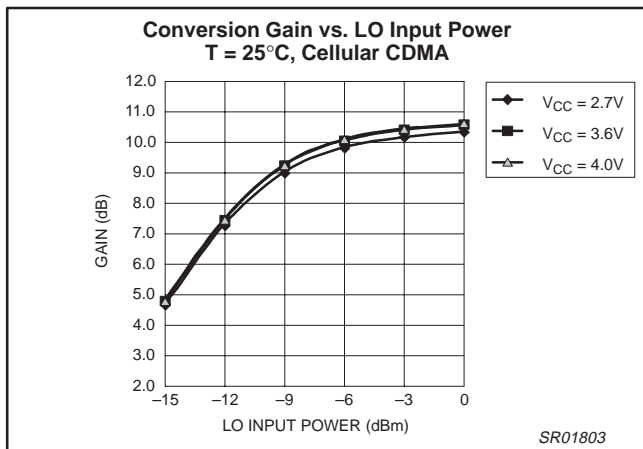

Figure 23.

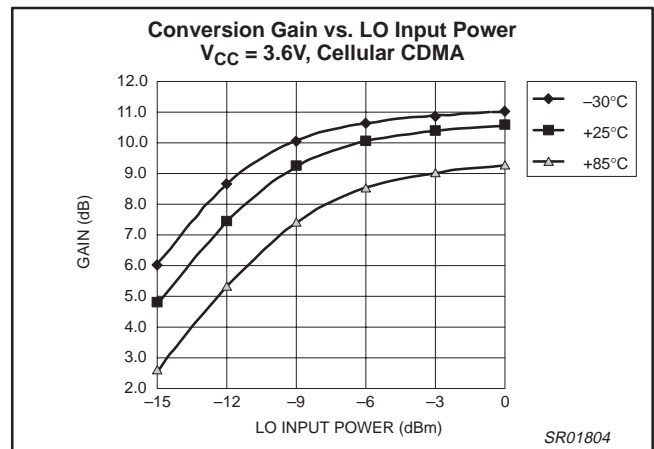

Figure 24.

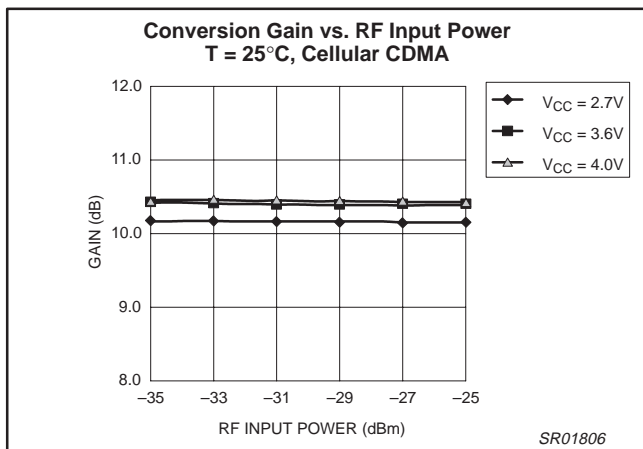

Figure 25.

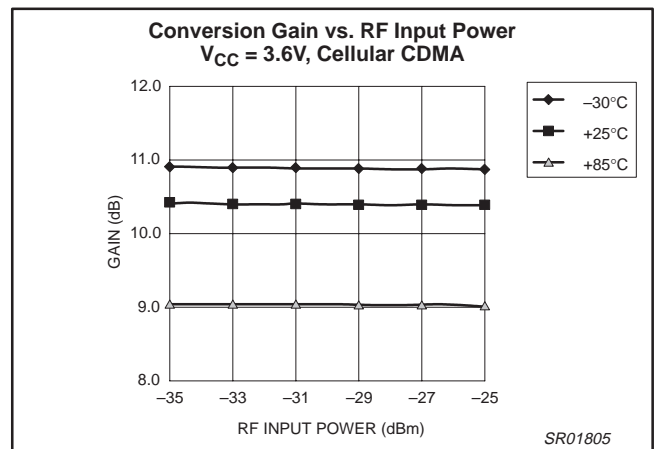

Figure 26.

Dual-band, CDMA/AMPS downconverter IC

SA9502

PERFORMANCE CHARACTERISTICS

Conversion Gain – PCS Mixer

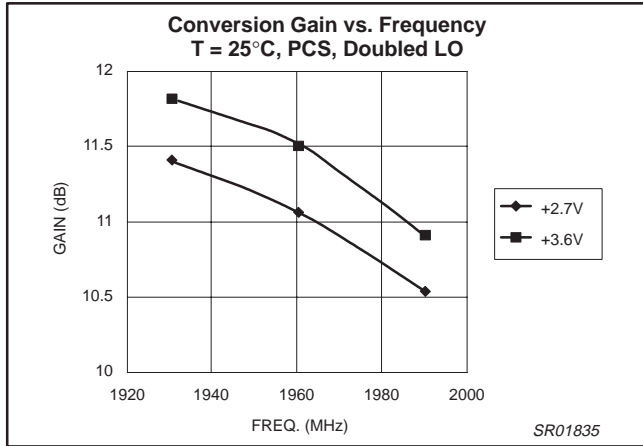

Figure 27.

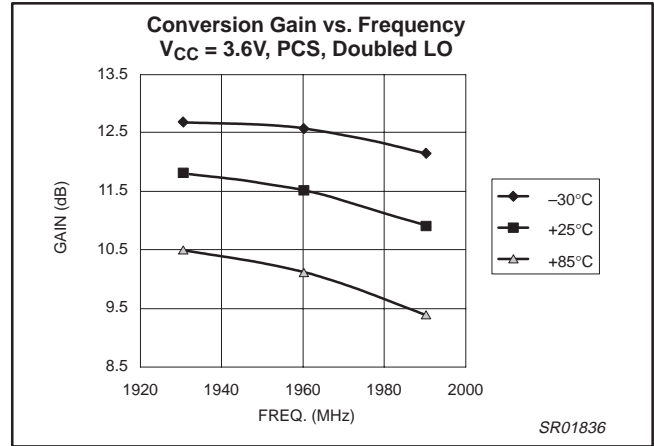

Figure 28.

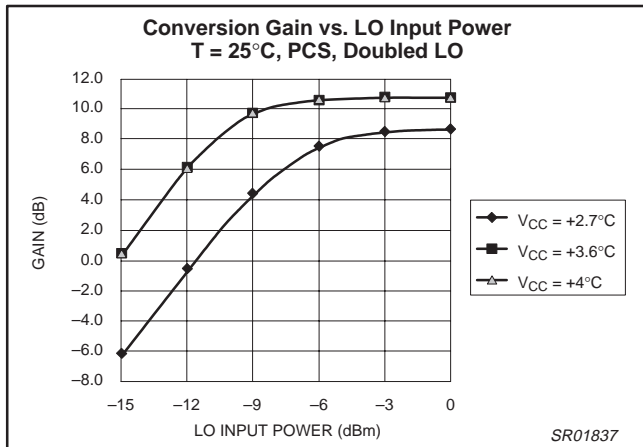

Figure 29.

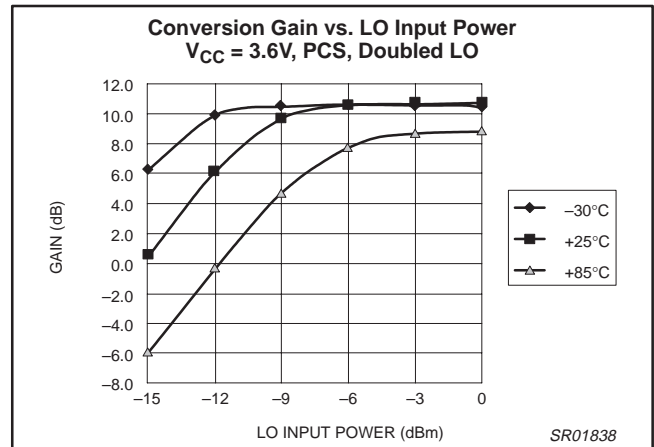

Figure 30.

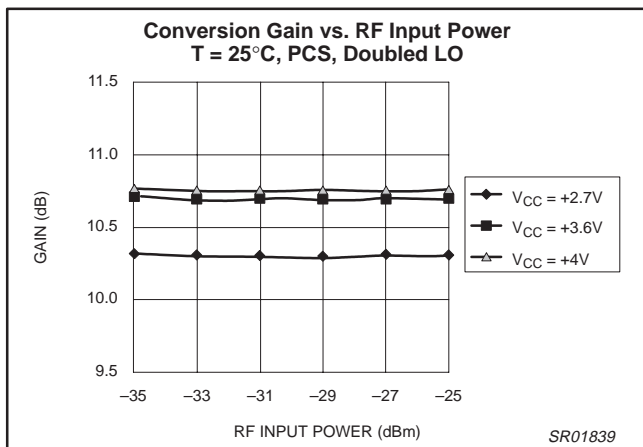

Figure 31.

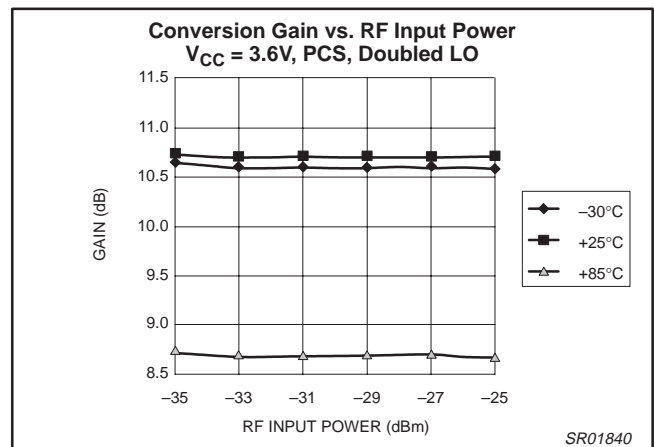

Figure 32.

Dual-band, CDMA/AMPS downconverter IC

SA9502

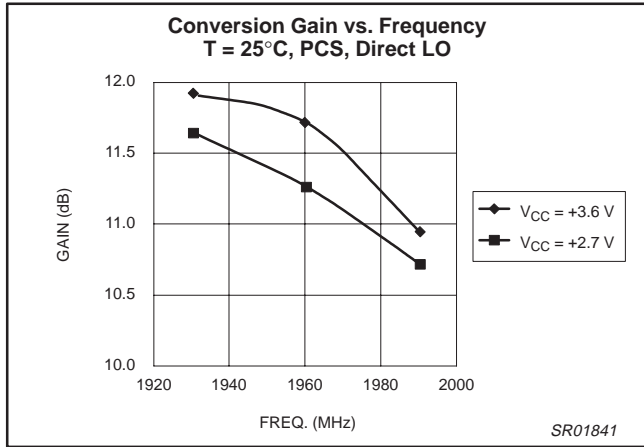

Figure 33.

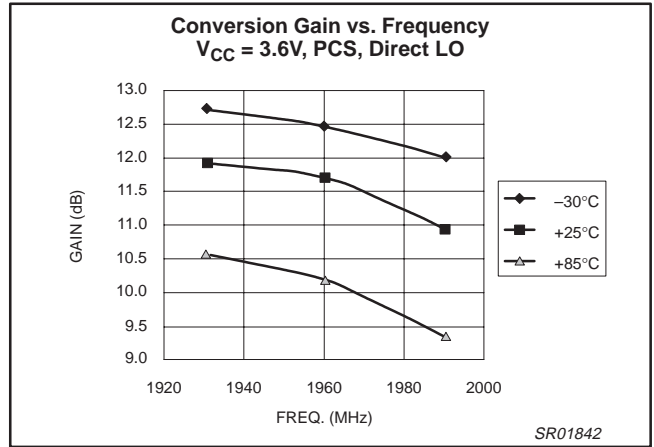

Figure 34.

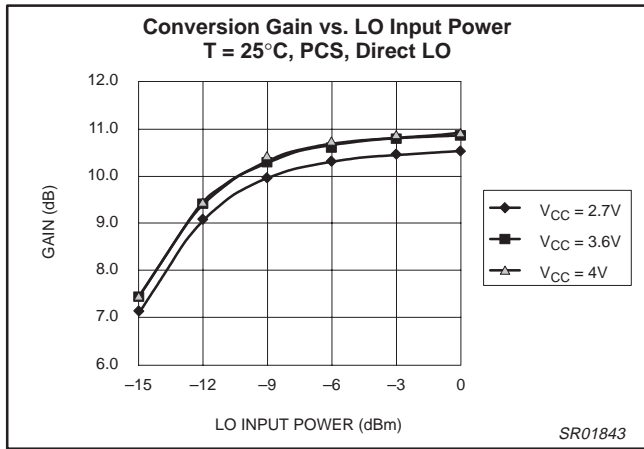

Figure 35.

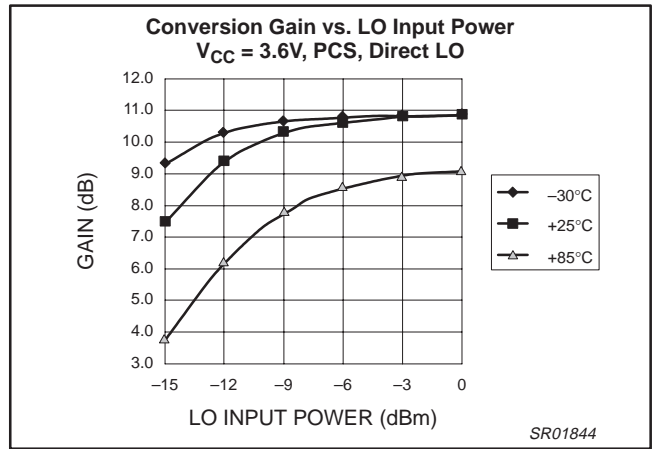

Figure 36.

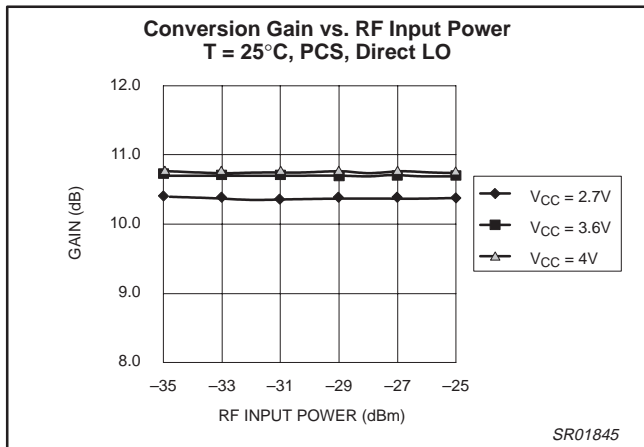

Figure 37.

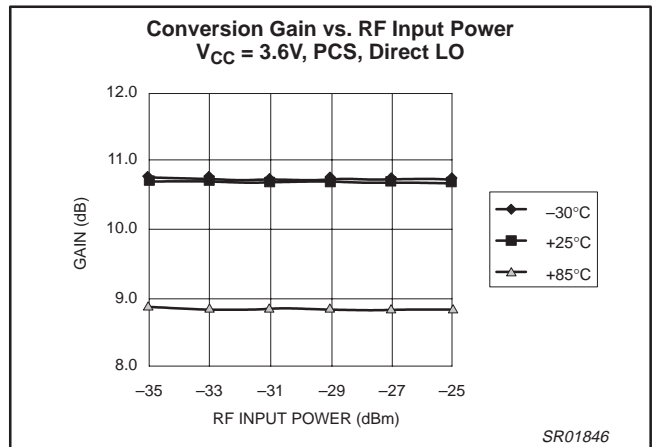

Figure 38.

Dual-band, CDMA/AMPS downconverter IC

SA9502

PERFORMANCE CHARACTERISTICS

Input IP3

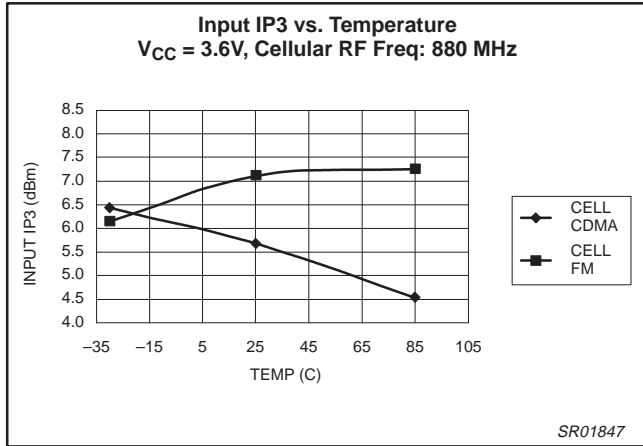

Figure 39.

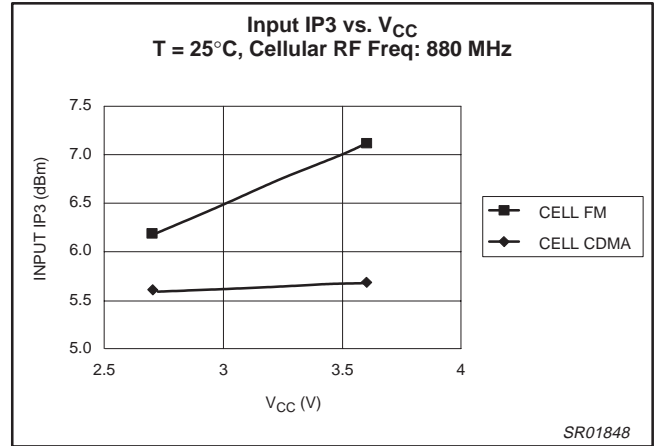

Figure 40.

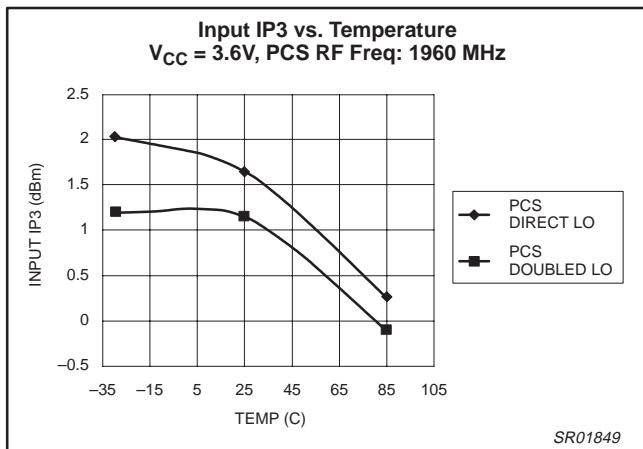

Figure 41.

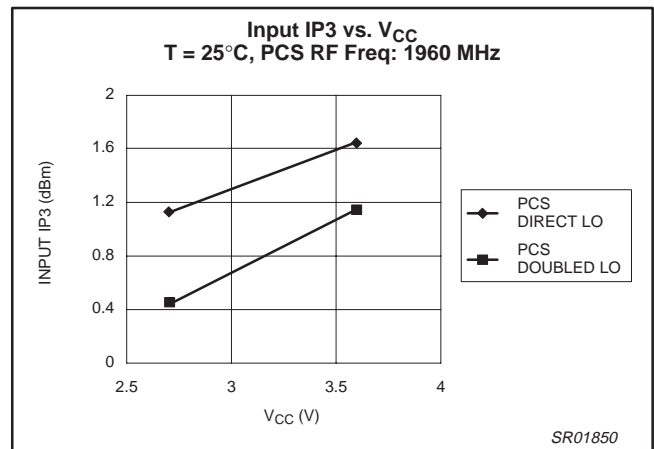

Figure 42.

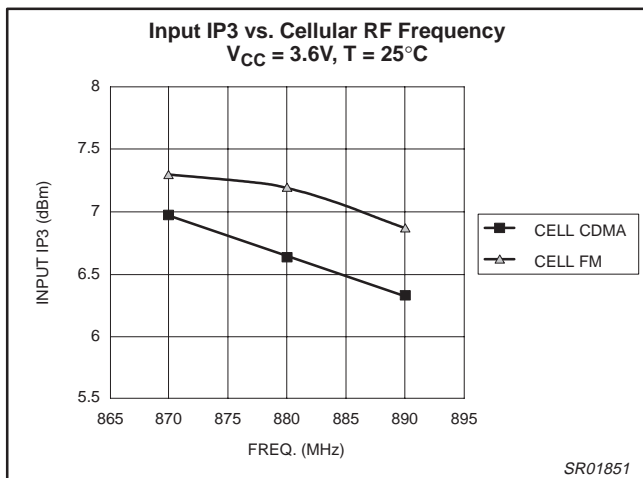

Figure 43.

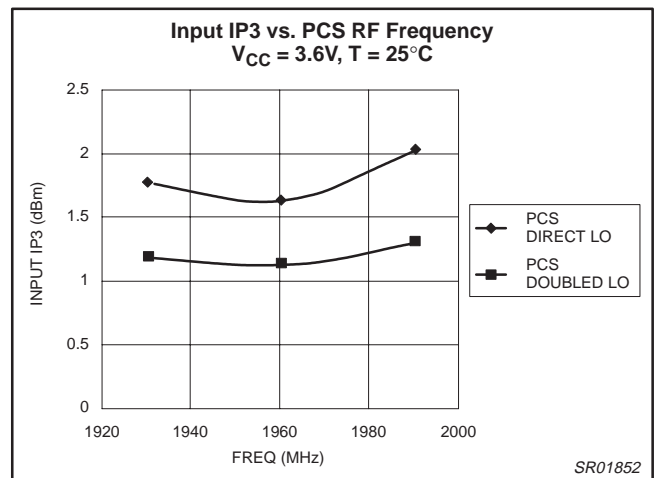

Figure 44.

Dual-band, CDMA/AMPS downconverter IC

SA9502

PERFORMANCE CHARACTERISTICS

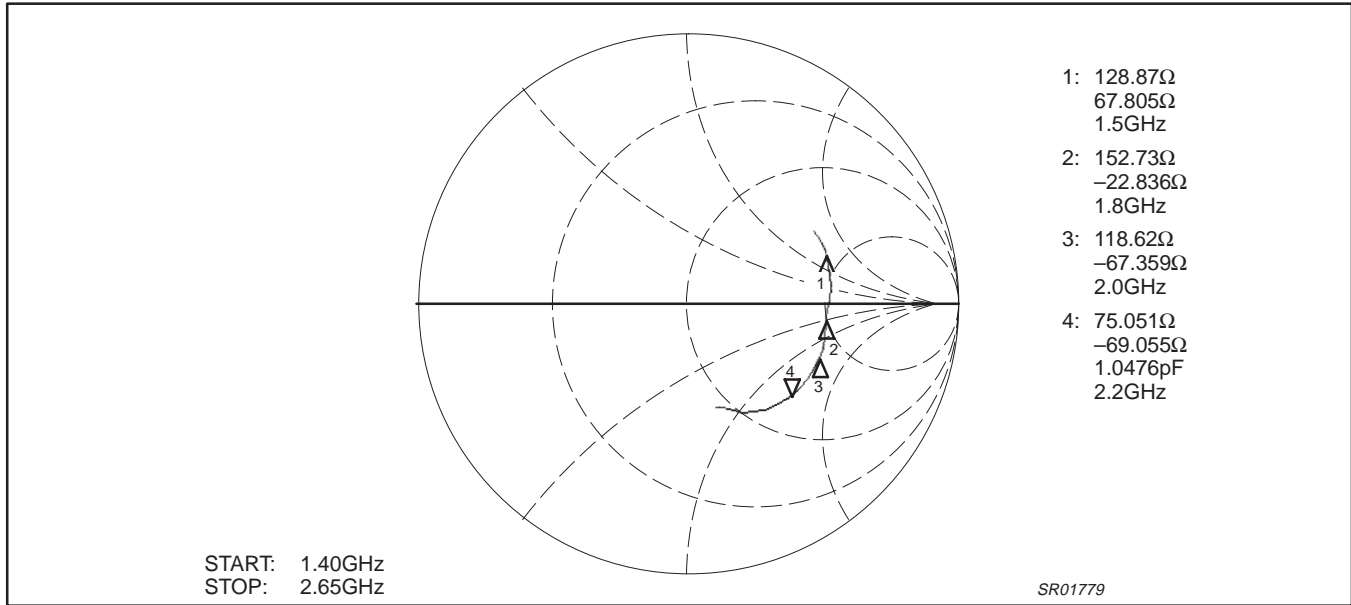

Figure 45. Typical S_{22} of LO Output for the PCS Band @ $V_{CC} = 3.6V$

Table 3. Typical S-Parameter of PCS LO Output @ $V_{CC} = 3.6V$

FREQUENCY (MHz)	$ S_{22} $	$\angle S_{22}$ (DEG)
1400	0.54	29.37
1450	0.54	25.04
1500	0.55	20.11
1550	0.54	15.16
1600	0.54	10.52
1650	0.54	6.32
1700	0.53	1.21
1750	0.52	-2.79
1800	0.51	-6.41
1850	0.52	-9.43
1900	0.52	-13.94
1950	0.53	-18.30
2000	0.53	-22.79
2050	0.53	-27.61
2100	0.53	-32.24
2150	0.52	-36.61
2200	0.52	-41.20
2250	0.51	-45.82
2300	0.50	-50.03
2350	0.49	-54.48
2400	0.47	-59.11
2450	0.46	-63.38
2500	0.43	-66.38
2550	0.42	-68.80
2600	0.41	-71.64
2650	0.41	-74.32

Dual-band, CDMA/AMPS downconverter IC

SA9502

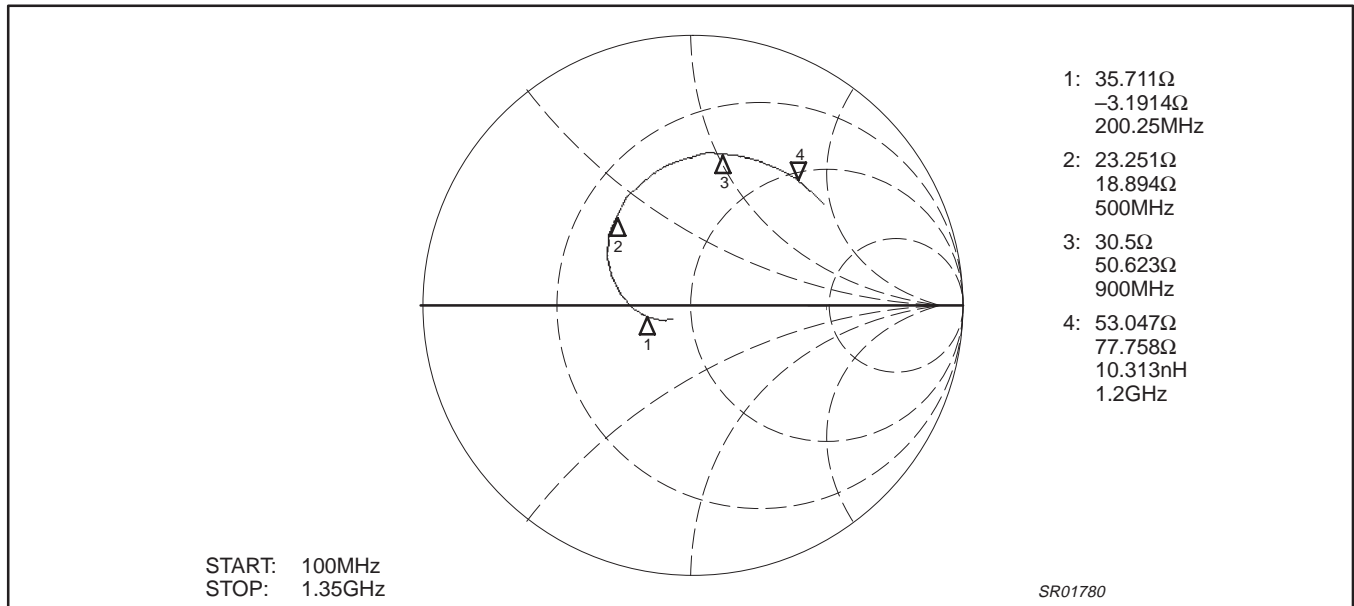

Figure 46. Typical S_{22} of LO Output for the Cellular Band @ $V_{CC} = 3.6V$

Table 4. Typical S-Parameter of LO Output for Cellular Band @ $V_{CC} = 3.6V$

FREQUENCY (MHz)	$ S_{22} $	$\angle S_{22}$ (DEG)
100	0.09	-143.49
150	0.13	-153.08
200	0.17	-165.13
250	0.21	-176.62
300	0.26	172.24
350	0.31	161.47
400	0.36	150.70
450	0.40	140.09
500	0.43	130.28
550	0.46	121.52
600	0.48	113.59
650	0.50	106.59
700	0.52	100.18
750	0.54	94.52
800	0.55	89.12
850	0.56	84.05
900	0.57	78.74
950	0.57	73.92
1000	0.58	69.23
1050	0.59	64.44
1100	0.59	59.62
1150	0.60	55.17
1200	0.60	50.70
1250	0.60	46.34
1300	0.61	42.11
1350	0.61	37.86

Dual-band, CDMA/AMPS downconverter IC

SA9502

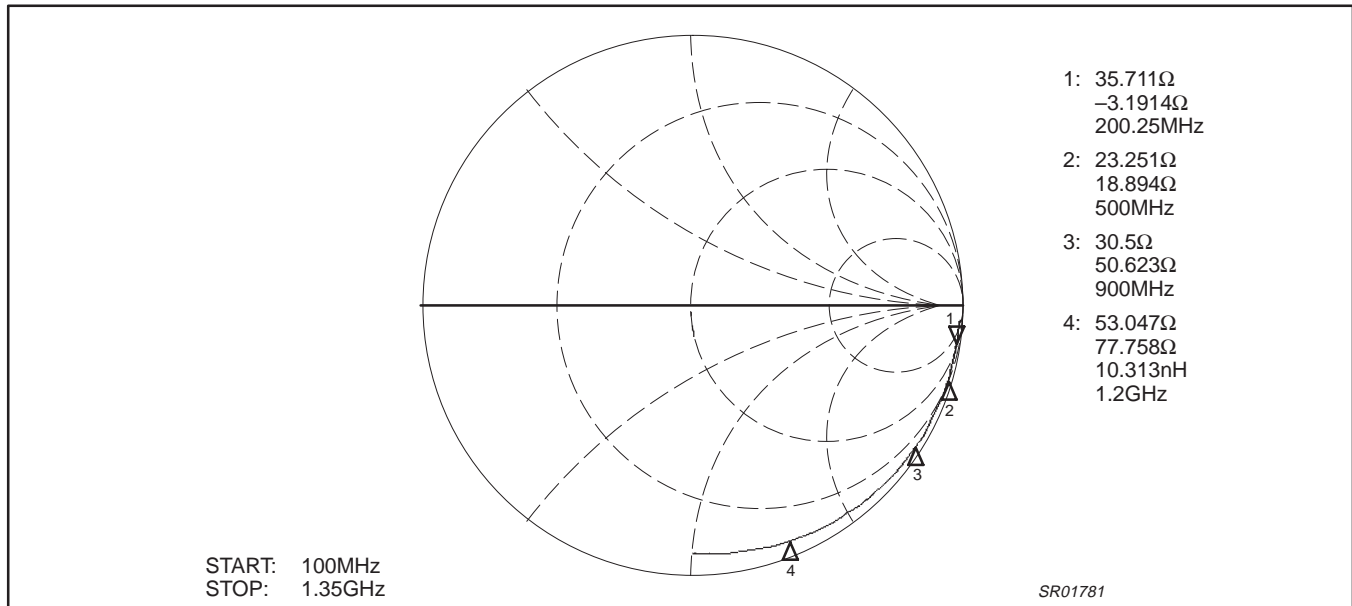

Figure 47. Typical S_{22} of CDMA IF, CDMA IFB, FM IF and FM IFB Output @ $V_{CC} = 3.6V$

Table 5. Typical S-Parameter of CDMA IF and CDMA IFB, FM IF and FM IFB Output @ 3.6V

Frequency (MHz)	CDMA IF and CDMA IFB Modes		FM IF and FM IFB Modes	
	$ S_{22} $	$\angle S_{22}$ (DEG)	$ S_{22} $	$\angle S_{22}$ (DEG)
20	0.99	-3.28	0.99	-3.47
40	0.99	-6.54	0.99	-6.84
60	0.99	-9.66	0.99	-10.15
80	0.98	-12.94	0.99	-13.58
100	0.98	-16.27	0.99	-17.02
120	0.98	-19.53	0.99	-20.40
140	0.98	-22.81	0.98	-23.76
160	0.98	-26.02	0.98	-27.01
180	0.98	-29.28	0.98	-30.48
200	0.98	-32.69	0.97	-33.94
220	0.97	-35.92	0.97	-37.22
240	0.97	-39.50	0.97	-40.78
260	0.96	-42.76	0.96	-44.19
280	0.96	-46.15	0.95	-47.55
300	0.96	-49.62	0.95	-51.00
320	0.96	-53.12	0.94	-54.46
340	0.95	-56.57	0.94	-57.83
360	0.95	-60.22	0.93	-61.32
380	0.95	-63.71	0.92	-64.61
400	0.94	-67.33	0.92	-68.11
420	0.94	-70.92	0.91	-71.43
440	0.93	-74.64	0.90	-74.72
460	0.93	-78.22	0.90	-78.22
480	0.93	-81.92	0.89	-81.58
500	0.92	-85.75	0.88	-84.90
520	0.91	-89.44	0.88	-88.28

Dual-band, CDMA/AMPS downconverter IC

SA9502

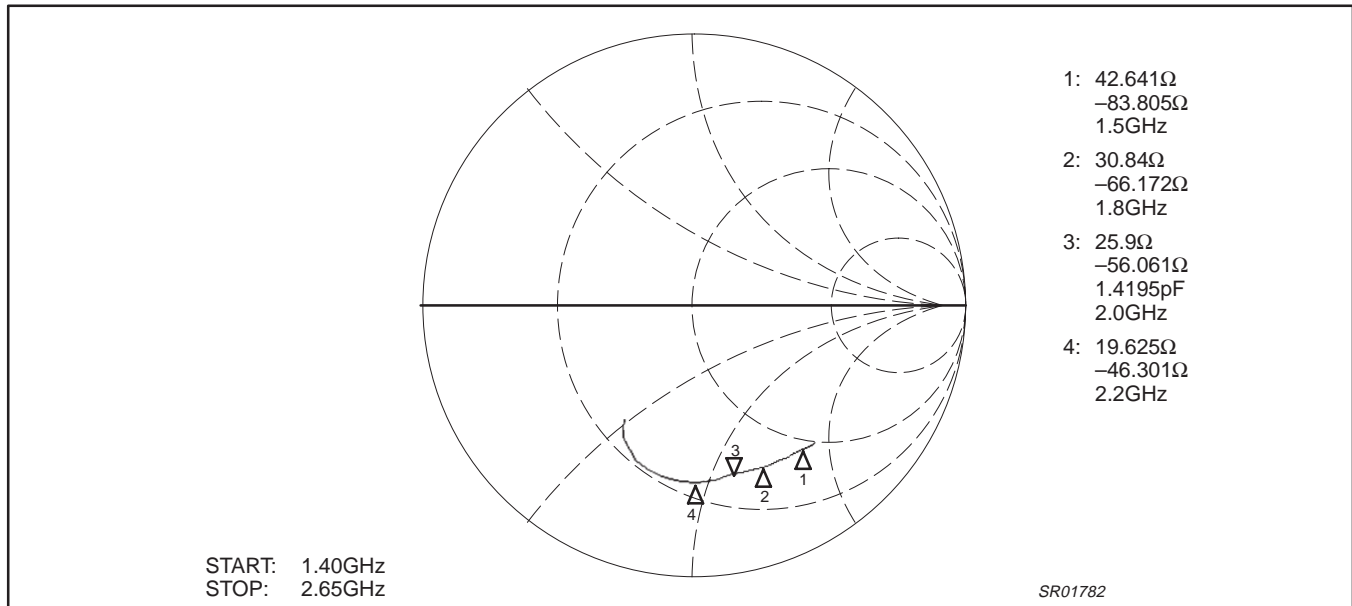

Figure 48. Typical S₁₁ of PCS RF and PCS RFB Input @ V_{CC} = 3.6V

Table 6. Typical S-Parameter of PCS RF and PCS RFB Input @ V_{CC} = 3.6V

FREQUENCY (MHz)	S ₁₁	<S ₁₁ (DEG)
1400	0.68	-48.65
1450	0.68	-50.83
1500	0.68	-52.86
1550	0.67	-55.14
1600	0.67	-57.35
1650	0.67	-59.59
1700	0.66	-62.09
1750	0.66	-64.21
1800	0.66	-66.78
1850	0.66	-69.35
1900	0.65	-71.92
1950	0.65	-74.58
2000	0.65	-76.86
2050	0.65	-79.82
2100	0.66	-82.80
2150	0.66	-85.95
2200	0.66	-89.71
2250	0.66	-93.52
2300	0.66	-97.51
2350	0.65	-101.41
2400	0.63	-105.60
2450	0.61	-109.66
2500	0.59	-114.00
2550	0.56	-117.05
2600	0.53	-119.59
2650	0.50	-120.82

Dual-band, CDMA/AMPS downconverter IC

SA9502

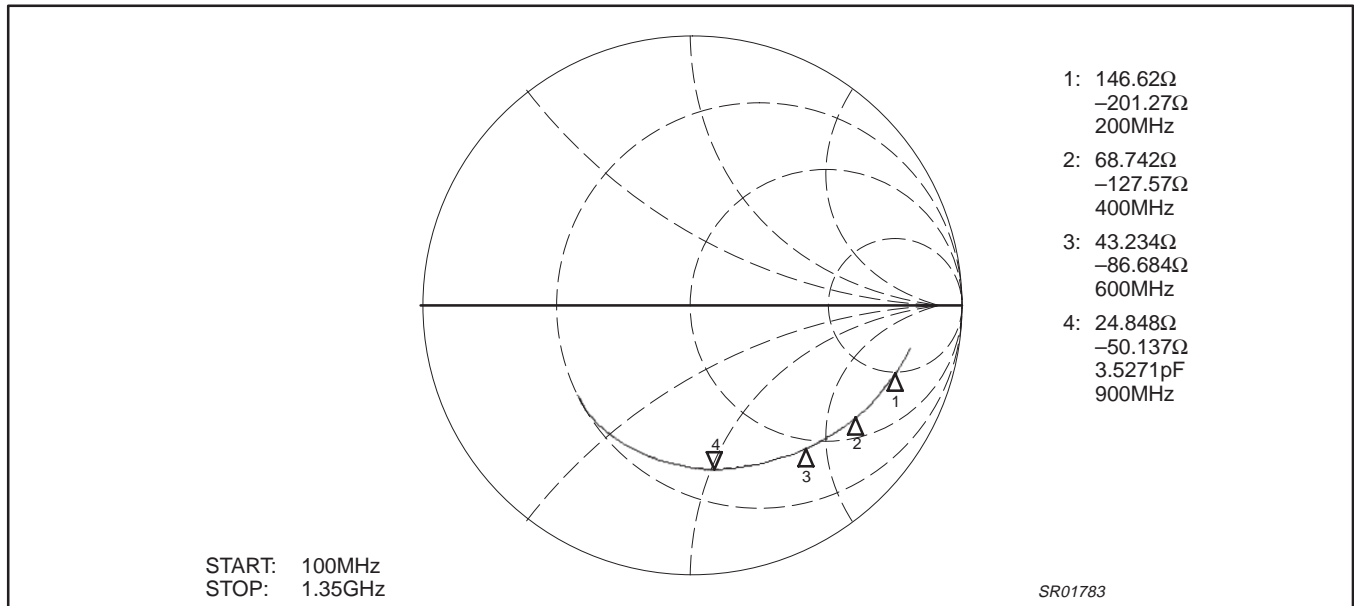

Figure 49. Typical S₁₁ of Cellular RF Input for CDMA and FM Mode @ V_{CC} = 3.6V

Table 7. Typical S-Parameter of Cellular RF Input for CDMA and FM Modes @3.6V

Frequency (MHz)	CDMA Mode		FM Mode	
	S ₁₁	<S ₁₁ (DEG)	S ₁₁	<S ₁₁ (DEG)
100	0.82	-11.35	0.77	-10.9
150	0.81	-14.93	0.76	-15.1
200	0.79	-18.80	0.75	-19.9
250	0.78	-22.71	0.74	-25.0
300	0.77	-26.70	0.72	-29.9
350	0.75	-30.70	0.70	-34.9
400	0.74	-34.86	0.68	-39.8
450	0.72	-39.00	0.65	-44.5
500	0.71	-43.20	0.63	-48.6
550	0.69	-47.57	0.60	-53.1
600	0.68	-52.12	0.58	-56.9
650	0.67	-56.63	0.57	-60.6
700	0.66	-61.76	0.56	-64.5
750	0.64	-66.93	0.56	-68.5
800	0.63	-72.01	0.58	-74.2
850	0.63	-77.55	0.57	-84.4
900	0.62	-83.91	0.53	-89.7
950	0.61	-90.43	0.51	-93.9
1000	0.60	-96.60	0.50	-97.8
1050	0.59	-103.02	0.50	-102.4
1100	0.58	-109.59	0.50	-107.3
1150	0.58	-116.16	0.50	-112.4
1200	0.57	-123.11	0.51	-117.5
1250	0.56	-129.79	0.51	-122.1
1300	0.55	-136.62	0.52	-126.6
1350	0.54	-143.51	0.52	-131.3

Dual-band, CDMA/AMPS downconverter IC

SA9502

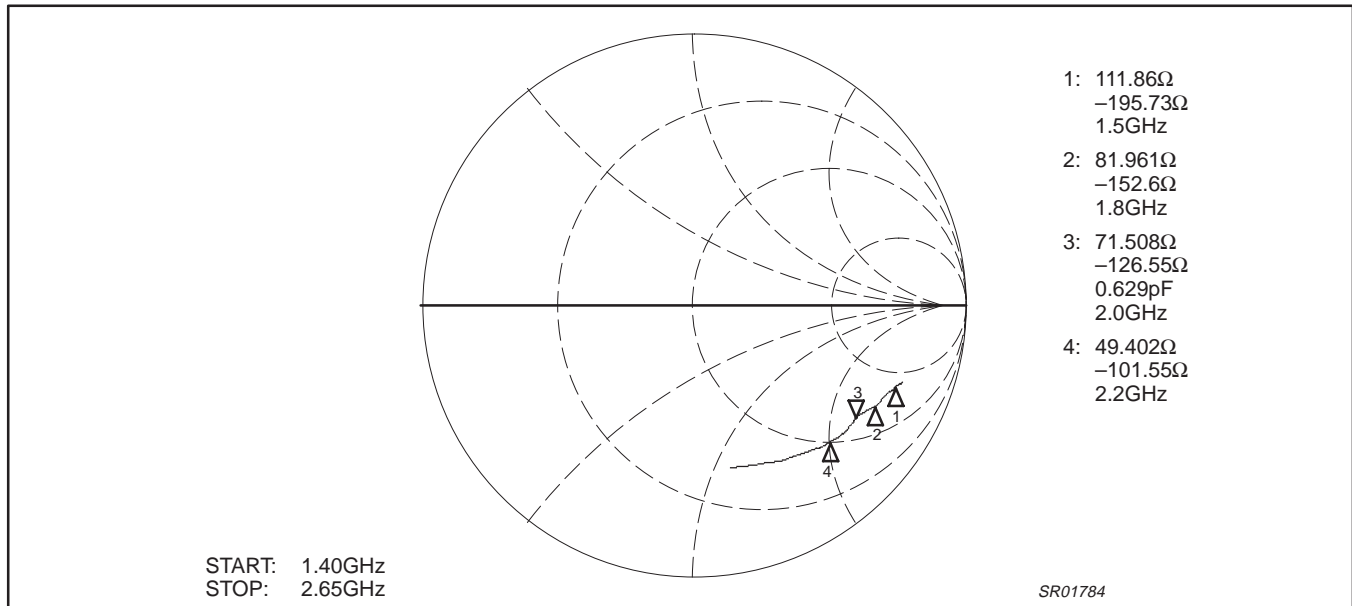

Figure 50. Typical S_{11} of PCS LO Input @ $V_{CC} = 3.6V$

Table 8. Typical S-Parameter of PCS LO Input @ $V_{CC} = 3.6V$

FREQUENCY (MHz)	$ S_{11} $	$\angle S_{11}$ (DEG)
1400	0.82	-20.14
1450	0.81	-21.11
1500	0.81	-21.93
1550	0.80	-23.12
1600	0.79	-24.11
1650	0.79	-24.83
1700	0.78	-26.31
1750	0.78	-27.29
1800	0.77	-28.94
1850	0.76	-30.10
1900	0.75	-31.60
1950	0.74	-33.13
2000	0.73	-34.39
2050	0.74	-36.43
2100	0.73	-39.44
2150	0.72	-41.87
2200	0.71	-44.83
2250	0.71	-47.44
2300	0.70	-50.37
2350	0.69	-53.39
2400	0.67	-56.89
2450	0.66	-60.64
2500	0.65	-64.62
2550	0.63	-68.76
2600	0.62	-72.84
2650	0.62	-76.87

Dual-band, CDMA/AMPS downconverter IC

SA9502

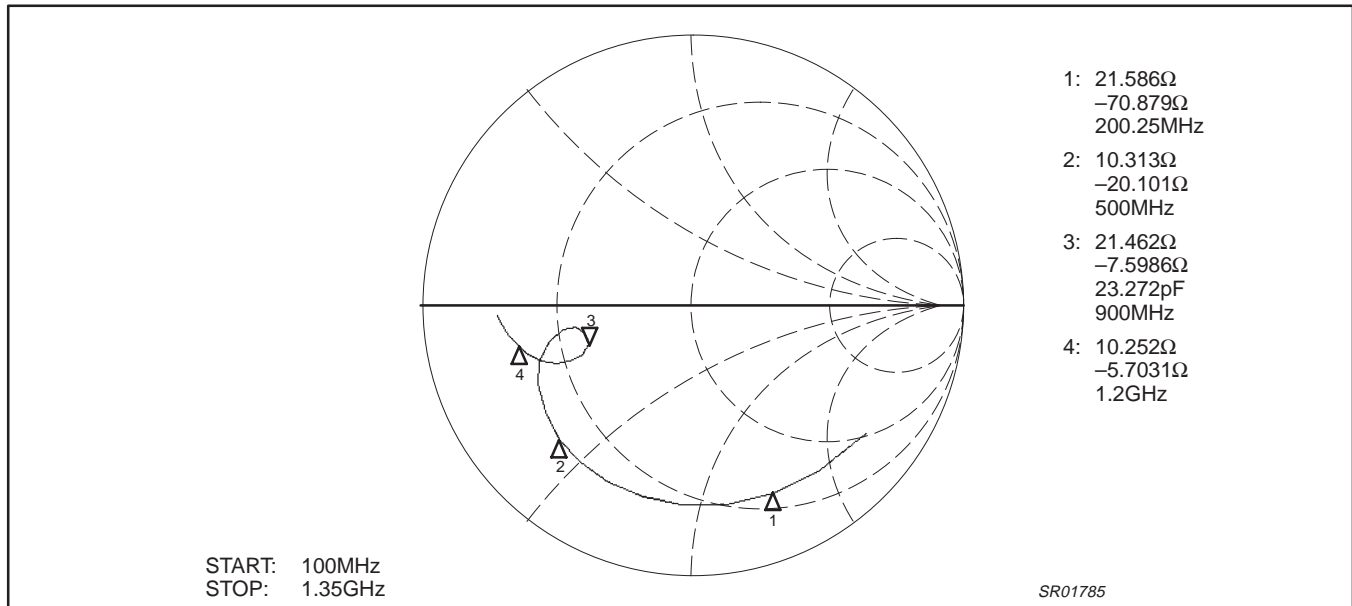

Figure 51. Typical S_{11} of Cellular LO Input @ $V_{CC} = 3.6V$

Table 9. Typical S-Parameter of Cellular LO Input @ $V_{CC} = 3.6V$

FREQUENCY (MHz)	$ S_{11} $	$\angle S_{11}$ (DEG)
100	0.80	-36.97
150	0.77	-52.45
200	0.76	-67.08
250	0.75	-80.65
300	0.74	-93.04
350	0.73	-014.39
400	0.73	-115.23
450	0.71	-125.18
500	0.70	-134.67
550	0.68	-143.76
600	0.64	-152.26
650	0.60	-159.64
700	0.55	-165.56
750	0.49	-168.90
800	0.44	-168.40
850	0.41	-164.76
900	0.41	-158.85
950	0.45	-155.08
1000	0.50	-154.81
1050	0.55	-156.51
1100	0.60	-159.60
1150	0.63	-162.92
1200	0.66	-166.51
1250	0.69	-169.86
1300	0.71	-173.54
1350	0.72	-176.65

Dual-band, CDMA/AMPS downconverter IC

SA9502

DEMONSTRATION BOARD DIAGRAM

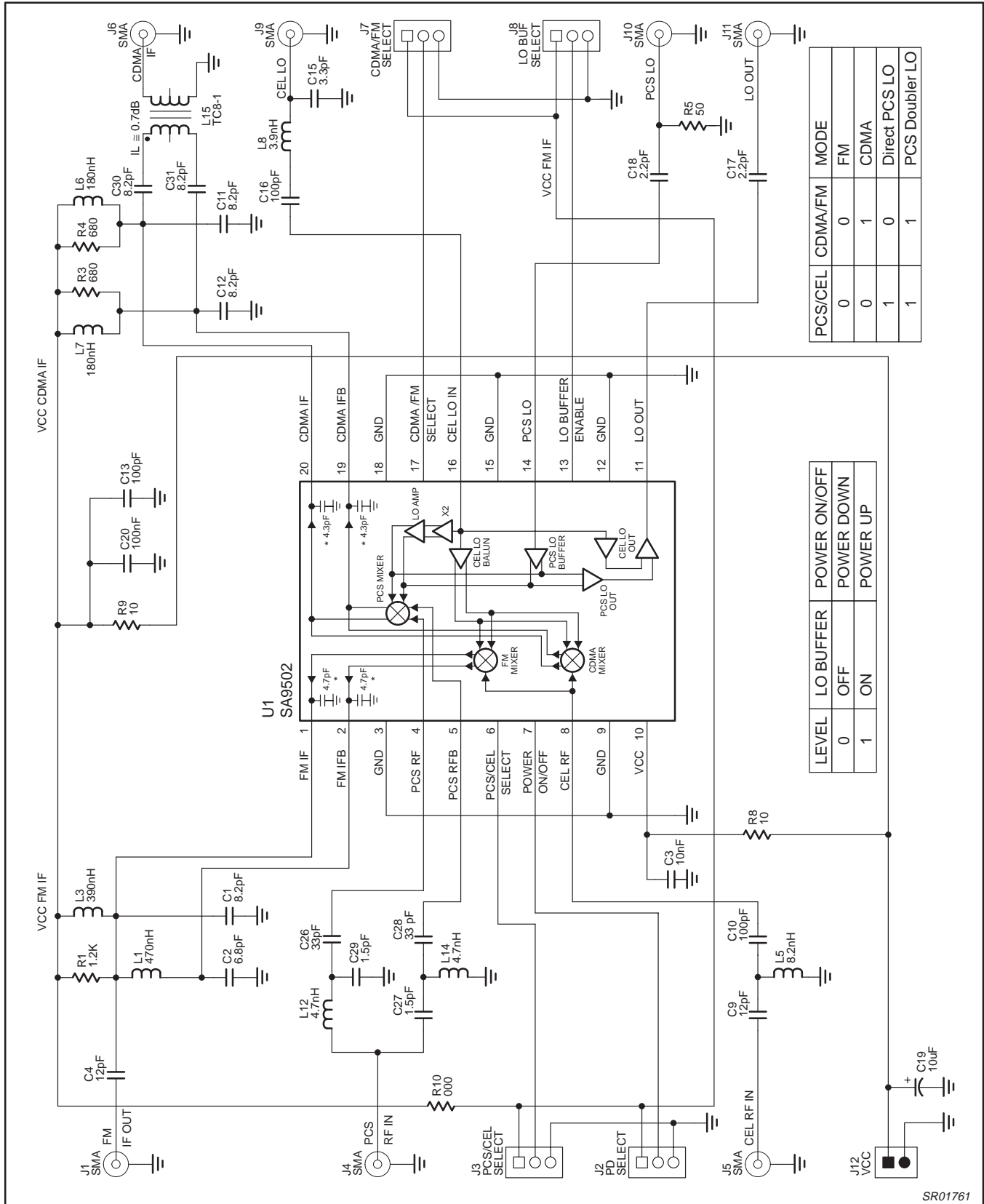

SR01761

Dual-band, CDMA/AMPS downconverter IC

SA9502

APPLICATION BLOCK DIAGRAM

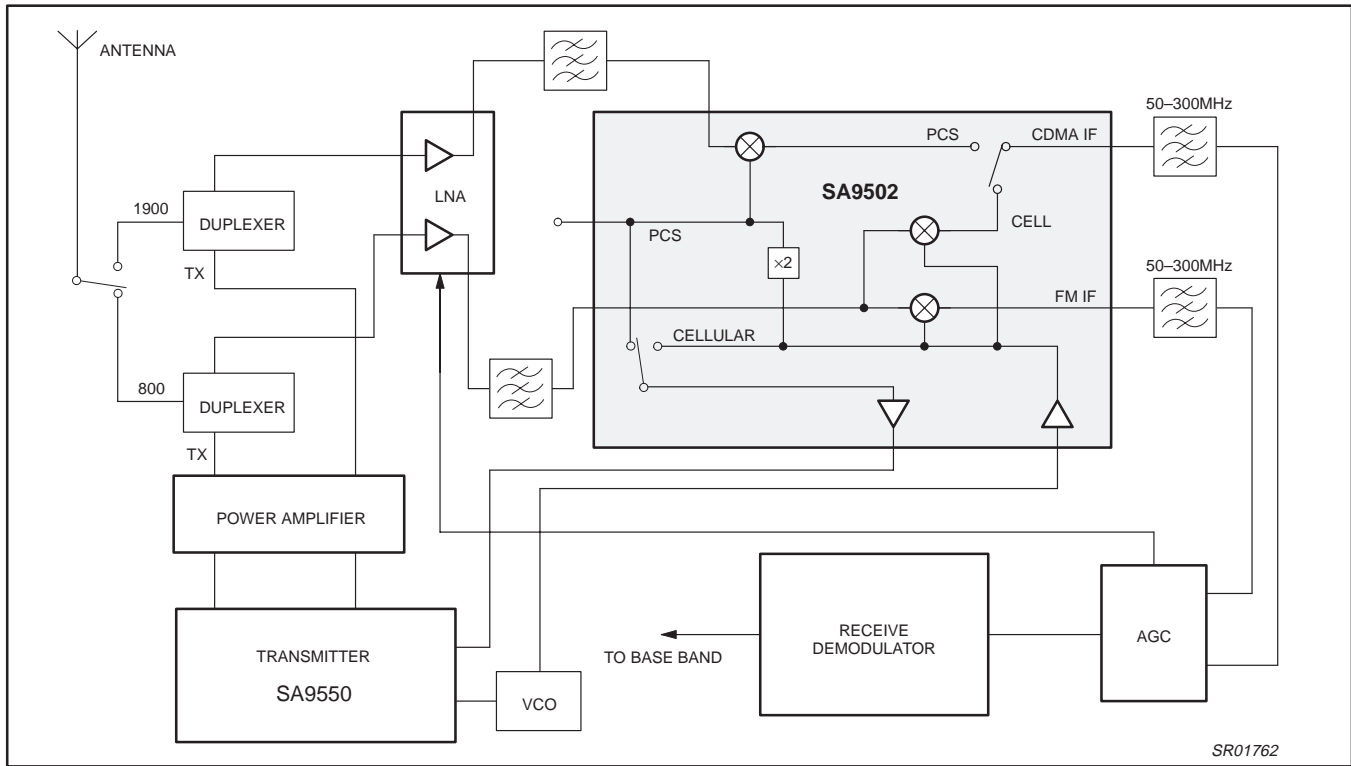

Dual-band, CDMA/AMPS downconverter IC

SA9502

TSSOP20: plastic thin shrink small outline package; 20 leads; body width 4.4 mm

SOT360-1

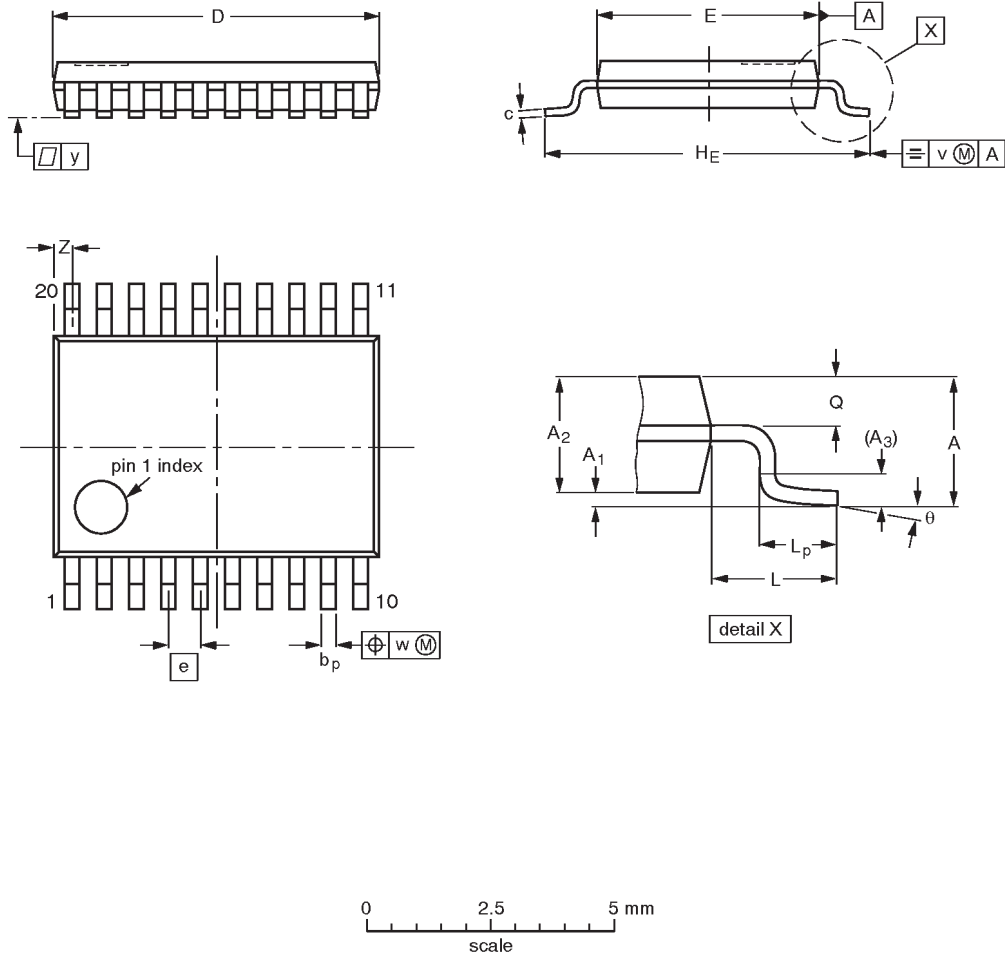

DIMENSIONS (mm are the original dimensions)

UNIT	A max.	A ₁	A ₂	A ₃	b _p	c	D ⁽¹⁾	E ⁽²⁾	e	H _E	L	L _p	Q	v	w	y	Z ⁽¹⁾	θ
mm	1.10	0.15 0.05	0.95 0.80	0.25	0.30 0.19	0.2 0.1	6.6 6.4	4.5 4.3	0.65	6.6 6.2	1.0	0.75 0.50	0.4 0.3	0.2	0.13	0.1	0.5 0.2	8° 0°

Notes

1. Plastic or metal protrusions of 0.15 mm maximum per side are not included.
2. Plastic interlead protrusions of 0.25 mm maximum per side are not included.

OUTLINE VERSION	REFERENCES				EUROPEAN PROJECTION	ISSUE DATE
	IEC	JEDEC	EIAJ			
SOT360-1		MO-153AC				-93-06-16- 95-02-04

Dual-band, CDMA/AMPS downconverter IC

SA9502

NOTES

Dual-band, CDMA/AMPS downconverter IC

SA9502

Data sheet status

Data sheet status	Product status	Definition [1]
Objective specification	Development	This data sheet contains the design target or goal specifications for product development. Specification may change in any manner without notice.
Preliminary specification	Qualification	This data sheet contains preliminary data, and supplementary data will be published at a later date. Philips Semiconductors reserves the right to make changes at any time without notice in order to improve design and supply the best possible product.
Product specification	Production	This data sheet contains final specifications. Philips Semiconductors reserves the right to make changes at any time without notice in order to improve design and supply the best possible product.

[1] Please consult the most recently issued datasheet before initiating or completing a design.

Definitions

Short-form specification — The data in a short-form specification is extracted from a full data sheet with the same type number and title. For detailed information see the relevant data sheet or data handbook.

Limiting values definition — Limiting values given are in accordance with the Absolute Maximum Rating System (IEC 134). Stress above one or more of the limiting values may cause permanent damage to the device. These are stress ratings only and operation of the device at these or at any other conditions above those given in the Characteristics sections of the specification is not implied. Exposure to limiting values for extended periods may affect device reliability.

Application information — Applications that are described herein for any of these products are for illustrative purposes only. Philips Semiconductors make no representation or warranty that such applications will be suitable for the specified use without further testing or modification.

Disclaimers

Life support — These products are not designed for use in life support appliances, devices or systems where malfunction of these products can reasonably be expected to result in personal injury. Philips Semiconductors customers using or selling these products for use in such applications do so at their own risk and agree to fully indemnify Philips Semiconductors for any damages resulting from such application.

Right to make changes — Philips Semiconductors reserves the right to make changes, without notice, in the products, including circuits, standard cells, and/or software, described or contained herein in order to improve design and/or performance. Philips Semiconductors assumes no responsibility or liability for the use of any of these products, conveys no license or title under any patent, copyright, or mask work right to these products, and makes no representations or warranties that these products are free from patent, copyright, or mask work right infringement, unless otherwise specified.

Philips Semiconductors
811 East Arques Avenue
P.O. Box 3409
Sunnyvale, California 94088-3409
Telephone 800-234-7381

© Copyright Philips Electronics North America Corporation 1999
All rights reserved. Printed in U.S.A.

Date of release: 03-99

Document order number:

9397 750 05472

Let's make things better.