

# Microminiature Low-Noise, Low-Saturation Three-Pin Regulator Monolithic IC MM1320

## Outline

This IC is a microminiature low-noise stabilized power supply device featuring a highly precise output voltage and a small input/output voltage difference of only 0.15V at an output current of 60mA.

The IC delivers output currents of up to rated 200mA, and through use of a noise pin output noise is diminished even further. An on/off pin can be used to turn the output on and off.

## Features

- |   |  |
|---|--|
| 1. Input/output voltage difference                                    | 0.15V typ. ( $I_o=60\text{mA}$ )                   |
| 2. Output noise voltage   | 30 $\mu\text{Vrms}$ typ. ( $C_n=0.01\mu\text{F}$ ) |
| 3. Recommended maximum output current                                 | 150mA max.   |
| 4. No-load input current  | 170 $\mu\text{A}$ typ.                             |
| 5. With internal overcurrent protection and thermal shutdown circuits |  |
| 6. Output voltage ranks   | 2~3.3V (0.1 V steps)<br>3.5V, 4V, 4.5V, 5V         |
| 7. Output on/off control function                                     | High : ON, Low : OFF                               |

## Package

SOT-25A (MM1320□N)

\*The output voltage rank appears in the boxes.

## Applications

1. Cordless phones
2. Portable phones, PHS
3. Portable minidisks
4. Portable equipment which uses batteries

## Pin Assignment

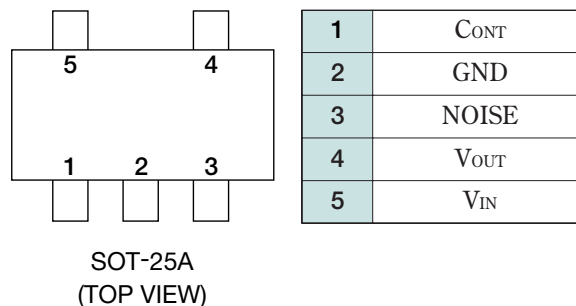

Equivalent Circuit Diagram

(MM1320)

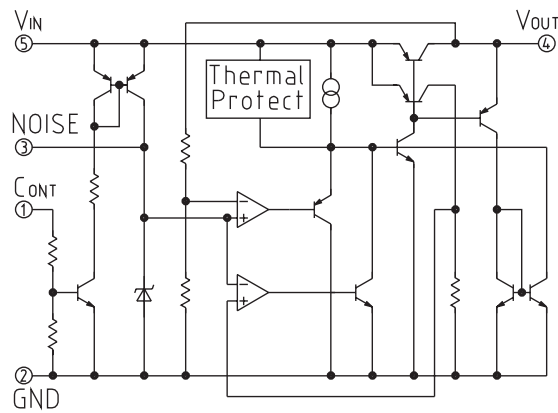

Absolute Maximum Ratings

Item	Symbol	Ratings	Units
Storage temperature	T <sub>STG</sub>	-40~+125	°C
Operating temperature	T <sub>OPR</sub>	-20~+75	°C
Power supply voltage	V <sub>CC</sub>	-0.3~+12	V
Output current	I <sub>OUT</sub>	200	mA
Power consumption	P <sub>d</sub>	150	mW

Recommended Operating Conditions

Item	Symbol	Ratings	Units
Operating temperature	T <sub>OPS</sub>	-20~+75	°C
Output current	I <sub>OPS</sub>	150	mA
Operating voltage	V <sub>OP</sub>	1.8~10	V

**Electrical Characteristics** (Except where noted otherwise, Ta=25°C)

Item	Symbol	Measurement conditions	Min.	Typ.	Max.	Units
Output voltage	V <sub>o</sub>	V <sub>IN</sub> =V <sub>OUT</sub> +1V, I <sub>o</sub> =30mA	V <sub>OUT</sub> -2%	V <sub>OUT</sub>	V <sub>OUT</sub> +2%	V
No-load consumption current	I <sub>ccq1</sub>	V <sub>IN</sub> =V <sub>OUT</sub> +1V, I <sub>o</sub> =0mA		170	340	μA
Input current while off	I <sub>ccq2</sub>	V <sub>IN</sub> =V <sub>OUT</sub> +1V, V <sub>cont</sub> =0V			1	μA
I/O voltage difference	V <sub>d min.</sub>	V <sub>IN</sub> =V <sub>OUT</sub> -0.2V, I <sub>o</sub> =60mA		0.15	0.25	V
Input fluctuations	ΔV <sub>1</sub>	V <sub>IN</sub> =V <sub>OUT</sub> +1V~5V, I <sub>o</sub> =30mA		10	20	mV
Load fluctuation	ΔV <sub>2</sub>	I <sub>o</sub> =0~100mA, V <sub>IN</sub> =V <sub>OUT</sub> +1V		30	60	mV
Output voltage temperature coefficient	ΔV <sub>o</sub> /ΔT	T <sub>j</sub> =-20~+75°C, I <sub>o</sub> =30mA V <sub>IN</sub> =V <sub>OUT</sub> +1V		100		ppm/°C
Ripple rejection rate	RR	V <sub>IN</sub> =V <sub>OUT</sub> +1V, f=120Hz V <sub>RIPPLE</sub> =1V, I <sub>o</sub> =30mA	50	60		dB
Output noise voltage	V <sub>n</sub>	V <sub>IN</sub> =V <sub>OUT</sub> +1V, f=20~80kHz I <sub>o</sub> =30mA, C <sub>noise</sub> =0.01uF		30 (3V item)		μV <sub>rms</sub>
CONT pin current while off	I <sub>OFF</sub>	V <sub>CONT</sub> =0.4V		1	3	μA
CONT pin current while on	I <sub>ON</sub>	V <sub>CONT</sub> =1.6V		5	10	μA
CONT pin high level	H		1.6		V <sub>IN</sub> +0.3	V
CONT pin low level	L		-0.3		0.4	V

**Measuring Circuit**

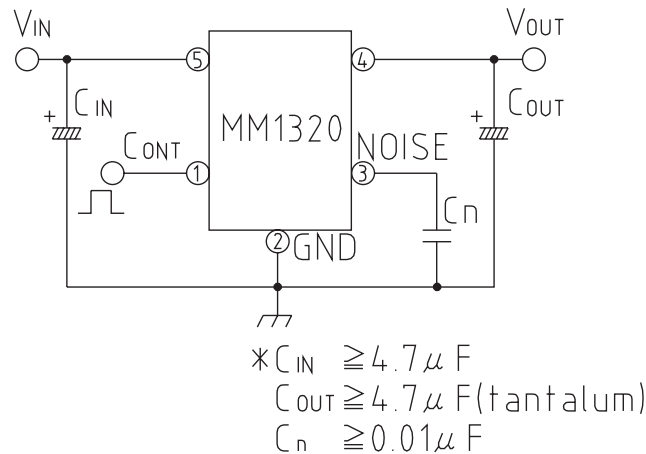

Note : The cause of oscillation is due to set wiring and capacitance changes in capacitor caused by temperatures changes, so please take extra care in placing the wires.

## Output voltage rank

Rnak	Voltage	Rnak	Voltage
A	5.0V	K	2.8V
B	4.5V	L	2.7V
C	4.0V	M	2.6V
D	3.5V	N	2.5V
E	3.3V	P	2.4V
F	3.2V	R	2.3V
G	3.1V	S	2.2V
H	3.0V	T	2.1V
J	2.9V	U	2.0V

## Characteristics (Represent model MM1320H)

### I/O voltage difference

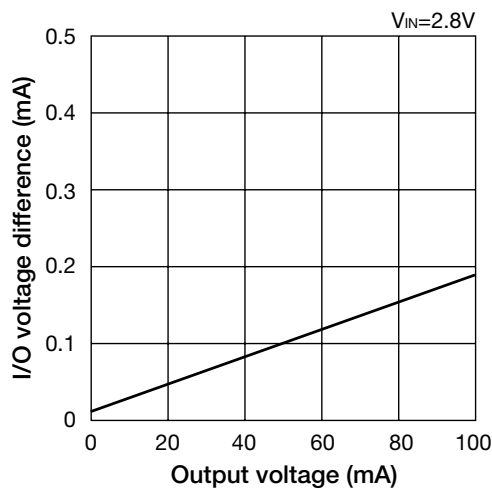

### Allowable loss

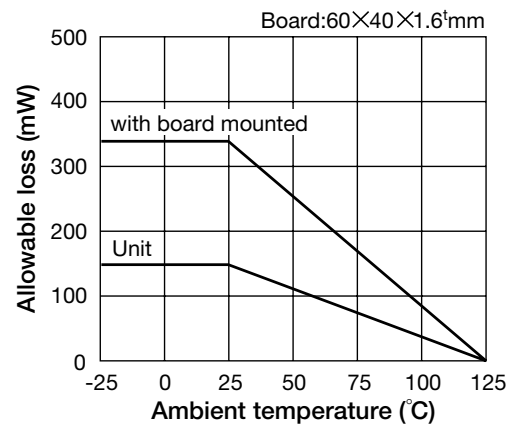

### Output voltage temperature characteristic

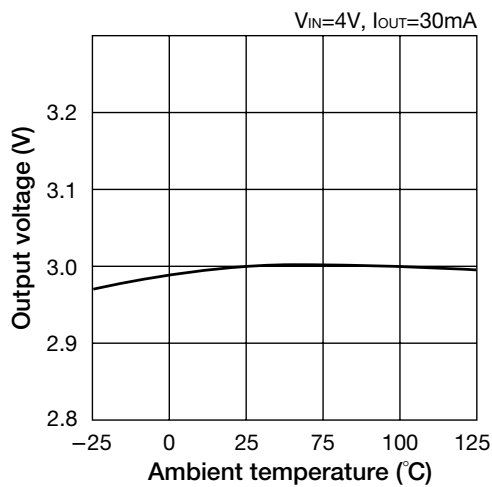

### No-load consumption current

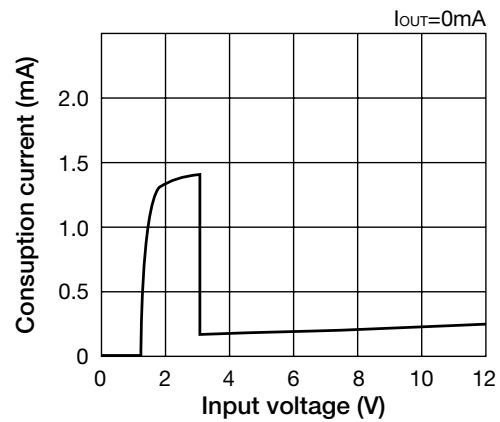

■ Output voltage

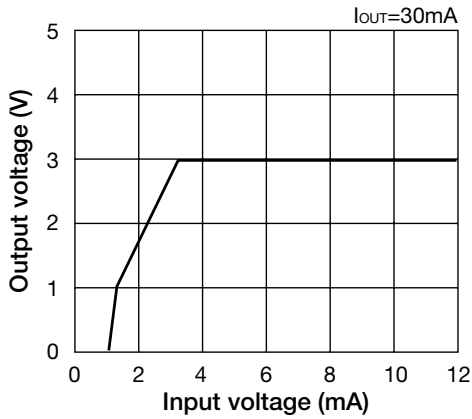

■ Input fluctuation

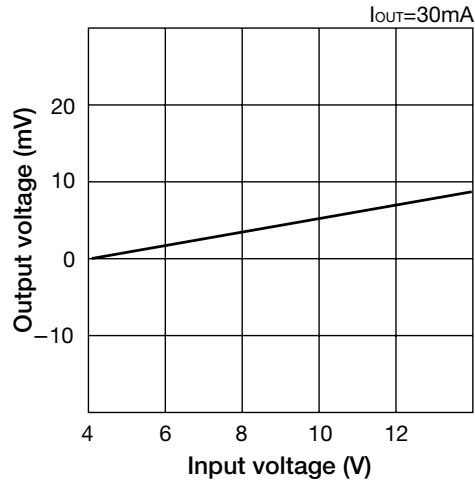

■ Load fluctuation

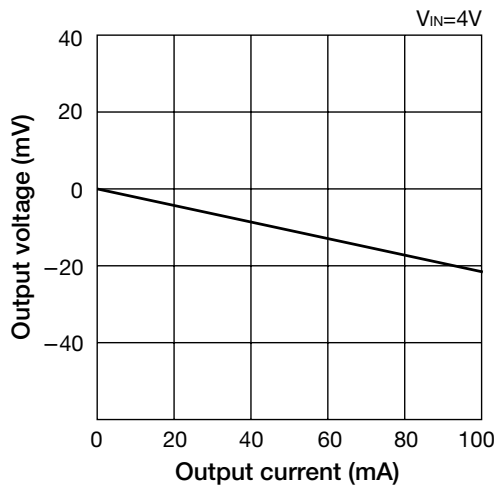

■ Current limit

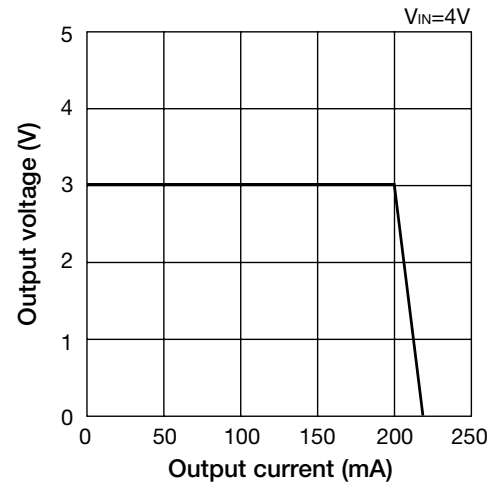

■ Ripple rejection rate

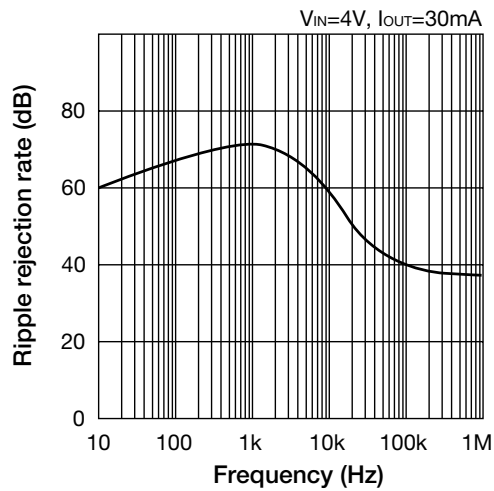

■ Input transient response

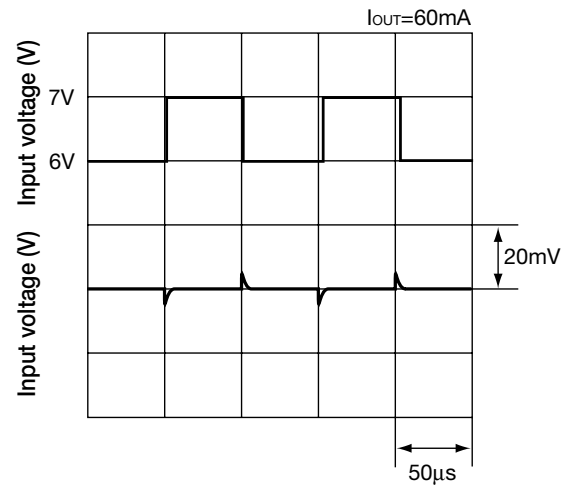

■ Output noise voltage

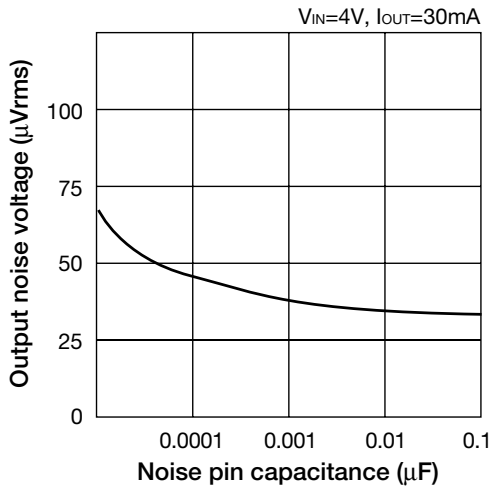

■ Input transient response

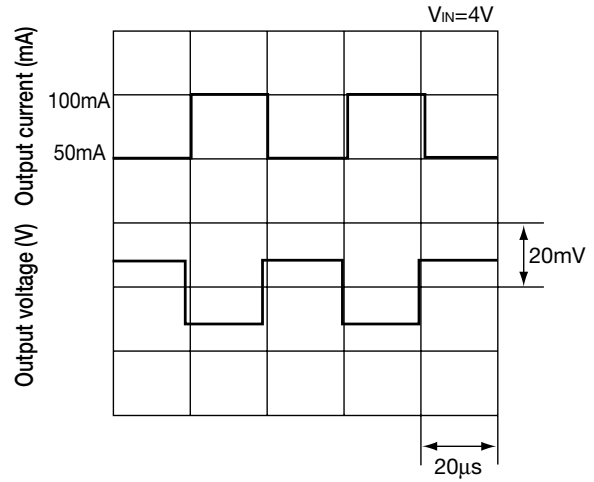

■ ESR Stable region (1320C)

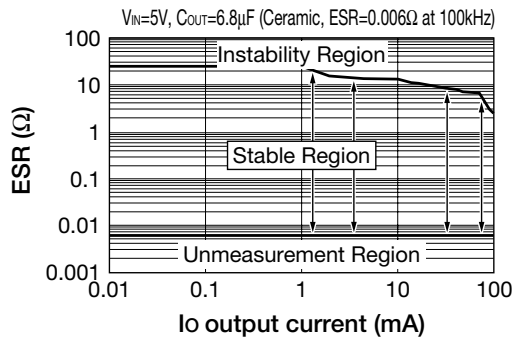

Note: Reference data