

Product Description

Stanford Microdevices' SNA-676 is a high-performance GaAs Heterojunction Bipolar Transistor (MMIC) housed in a low-cost surface mountable stripline package. A Darlington configuration is utilized for broadband performance to 6.5 GHz.

These unconditionally stable amplifiers provide 11dB of gain and +18dBm of P1dB when biased at 5.7V and 70mA. This MMIC requires only a single supply voltage. The use of an external resistor allows for bias flexibility and stability.

Also available in chip form (SNA-600), its small size (0.4mm x 0.4mm) and gold metallization make it an ideal choice for use in hybrid circuits.

The SNA-676 is available in tape and reel at 1000, 3000 and 5000 devices per reel.

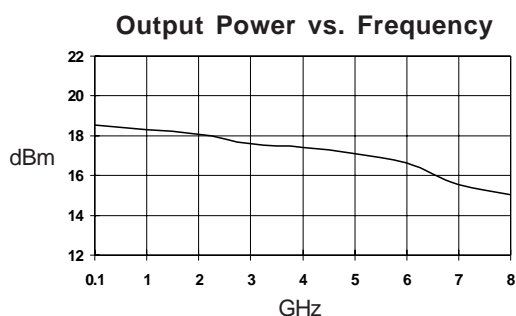

Electrical Specifications at Ta = 25C

Symbol	Parameters: Test Conditions: Id = 70 mA, Z0 = 50 Ohms		Units	Min.	Typ.	Max.
Gp	Small Signal Gain	f = 0.1-4.0 GHz f = 4.0-6.5 GHz	dB dB	9.0 8.0	11.0 9.0	
BW 3dB	3dB Bandwidth		GHz		6.5	
P1dB	Output Power at 1dB Compression	f = 0.1-2.0 GHz f = 2.0-6.5 GHz	dBm		18.0 16.0	
NF	Noise Figure	f = 0.1-4.0 GHz f = 4.0-6.5 GHz	dB		7.5 8.5	
VSWR	Input / Output	f = 0.1-6.5 GHz			1.5:1	
IP3	Third Order Intercept Point	f = 0.1-2.0 GHz	dBm		36.0	
TD	Group Delay	f = 2.0 GHz	psec		120	
ISOL	Reverse Isolation	f = 0.1-6.5 GHz	dB		17.0	
VD	Device Voltage		V	4.8	5.7	6.8
dG/dT	Device Gain Temperature Coefficient		dB/degC		-0.0023	
dV/dT	Device Voltage Temperature Coefficient		mV/degC		-5.0	

The information provided herein is believed to be reliable at press time. Stanford Microdevices assumes no responsibility for inaccuracies or omissions. Stanford Microdevices assumes no responsibility for the use of this information, and all such information shall be entirely at the user's own risk. Prices and specifications are subject to change without notice. No patent rights or licenses to any of the circuits described herein are implied or granted to any third party. Stanford Microdevices does not authorize or warrant any Stanford Microdevices product for use in life-support devices and/or systems. Copyright 1999 Stanford Microdevices, Inc. All worldwide rights reserved.

SNA-676

DC-6.5 GHz, Cascadable GaAs MMIC Amplifier



Product Features

- Cascadable 50 Ohm Gain Block
- 11dB Gain, +18dBm P1dB
- High Linearity, +36dBm TOIP Typ.
- 1.5:1 Input and Output VSWR
- Operates From a Single DC Supply
- Low Cost Stripline Mount Ceramic Package

Applications

- Narrow and Broadband Linear Amplifiers
- Commercial and Industrial Applications

SNA-676 DC-6.5 GHz Cascadable MMIC Amplifier

Typical Performance at 25° C ($V_{ds} = 5.7V$, $I_{ds} = 70mA$)

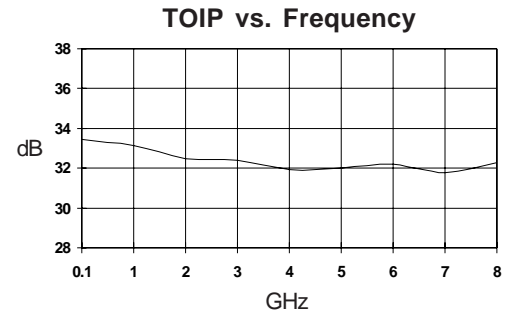
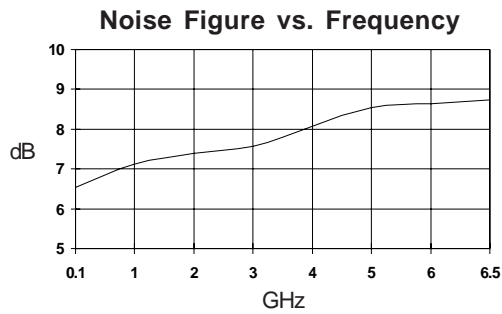
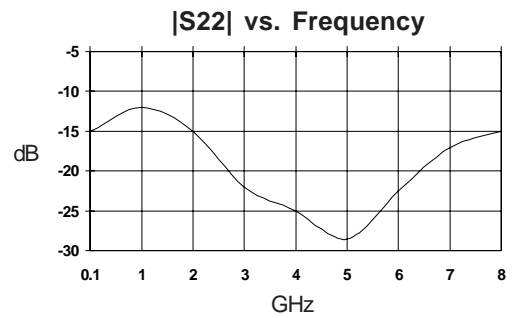
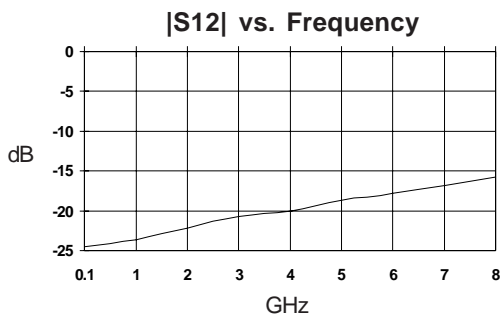
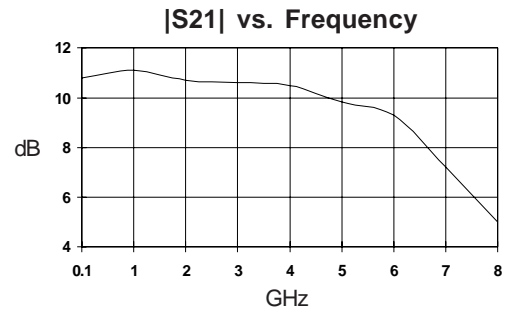
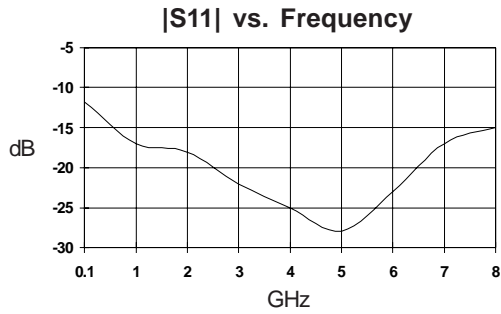

Typical S-Parameters $V_{ds} = 5.7V$, $I_{ds} = 70mA$

Freq GHz	S 11	S 11 Ang	S 21	S 21 Ang	S 12	S 12 Ang	S 22	S 22 Ang
.100	0.152	-14	3.624	152	0.095	-4	0.198	-4
.250	0.146	-25	3.602	145	0.139	-10	0.205	-26
.500	0.131	-42	3.549	140	0.149	-30	0.247	-56
1.00	0.110	-83	3.583	102	0.148	-59	0.222	-112
1.50	0.085	-130	3.567	59	0.146	-90	0.198	-179
2.00	0.072	178	3.541	21	0.145	-120	0.193	120
2.50	0.077	109	3.512	-22	0.141	-152	0.203	54
3.00	0.107	52	3.427	-64	0.136	180	0.222	1
3.50	0.143	0	3.401	-106	0.132	147	0.248	-60
4.00	0.168	-44	3.290	-144	0.128	118	0.270	-117
4.50	0.173	-90	3.280	175	0.124	88	0.288	177
5.00	0.141	-142	3.104	128	0.124	60	0.285	117
5.50	0.079	169	2.929	87	0.123	29	0.276	51
6.00	0.038	62	2.658	47	0.121	0	0.259	-10
6.50	0.079	-57	2.359	1	0.119	-35	0.322	-76

(S-Parameters include the effects of two 1.0 mil diameter bond wires, each 20 mils long, connected to the gate and drain pads on the die)

SNA-676 DC-6.5 GHz Cascadable MMIC Amplifier

Absolute Maximum Ratings

Parameter	Absolute Maximum
Device Current	110mA
Power Dissipation	700mW
RF Input Power	200mW
Junction Temperature	+200C
Operating Temperature	-45C to +85C
Storage Temperature	-65C to +150C

Notes:

1. Operation of this device above any one of these parameters may cause permanent damage.

Part Number Ordering Information

Part Number	Devices Per Reel	Reel Size
SNA-676-TR1	1000	7"
SNA-676-TR2	3000	13"
SNA-676-TR3	5000	13"

Recommended Bias Resistor Values						
Supply Voltage (Vs)	5V	7.5V	9V	12V	15V	20V
Rbias (Ohms)	*	24	46	89	131	203

** Not Recommended

MTTF vs. Temperature @ Id = 70mA

Lead Temperature	Junction Temperature	MTTF (hrs)
+55C	+155C	1000000
+90C	+190C	100000
+120C	+220C	10000

Thermal Resistance (Lead-Junction): 250° C/W

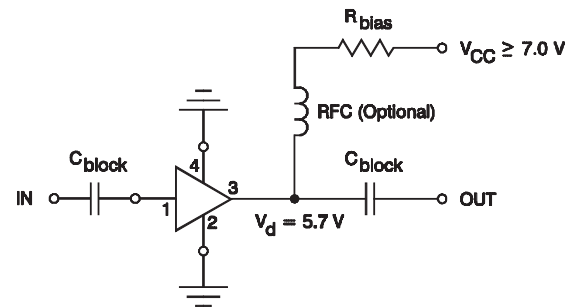

Typical Biasing Configuration

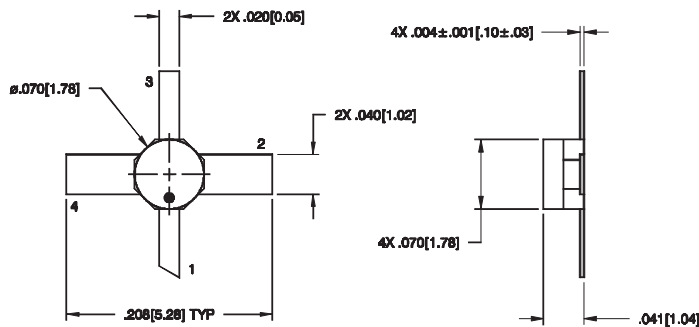

Pin Designation	
1	RF in
2	GND
3	RF out and Bias
4	GND

Typical Performance at 25° C

