



Product Description

Sirenza Microdevices' SNA-100S is a GaAs monolithic broadband amplifier (MMIC) in die form. This amplifier provides 12.2dB of gain at 1950 MHz and 10.3dB at 10,000 MHz.

These unconditionally stable amplifiers are designed for use as general purpose 50 ohm gain blocks. Its small size (0.350mm x 0.345mm) and gold metallization make it an ideal choice for use in hybrid circuits. The SNA-100S is 100% DC tested and sample tested for RF performance.

External DC decoupling capacitors determine low frequency response. The use of an external resistor allows for bias flexibility and stability.

The SNA-100S is supplied in gel paks of 100 devices. Also available in packaged form (SNA-176 & SNA-186)

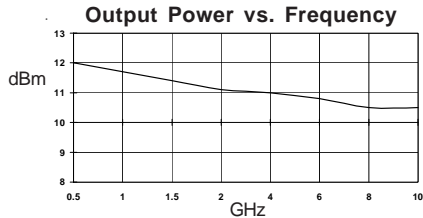

SNA-100S

DC-10 GHz, Cascadable GaAs HBT MMIC Amplifier



OBSOLETE

Last Time Buy Date: 6-May-2007

Final Shipment Date: 6-Nov-2007

Product Features

- Cascadable 50 Ohm Gain Block
- 12.2dB Gain, +11dBm P1dB
- 1.5:1 Input and Output VSWR
- Operates From Single Supply
- Through wafer via for ground

Applications

- Broadband Driver Amplifier
- IF Amplifier or gain stage for VSAT, LMDS, WLAN, and Cellular Systems

Symbol	Parameter	Units	Frequency	Min.	Typ.	Max.
G _p	Small Signal Power Gain [2]	dB	850 MHz		12.5	
		dB	1950 MHz	10.7	12.2	13.7
		dB	2400 MHz		12.0	
		dB	6000 MHz		12.5	
		dB	10000 MHz	8.8	10.3	11.8
G _F	Gain Ripple	dB	0.1-8 GHz		+/- 0.5	
BW _{3dB}	3dB Bandwidth	GHz			10.5	
P _{1dB}	Output Power at 1dB Compression [2]	dBm	1950 MHz	9	11.0	
		dBm	10000 MHz	9.5	11.5	
OIP ₃	Output Third Order Intercept Point [2]	dBm	1950 MHz	21	24.0	
		dBm	10000 MHz	21	24.0	
NF	Noise Figure	dB	1950 MHz		5	
RL	Input / Output Return Loss	dB	1950 MHz		13	
ISOL	Reverse Isolation	dB	0.1-10 GHz		16	
V _D	Device Operating Voltage [1]	V		3.1	3.6	4.1
I _D	Device Operating Current [1]	mA		35	40	45
dG/dT	Device Gain Temperature Coefficient	dB/°C			-0.0015	
R _{TH, j-b}	Thermal Resistance (junction to backside)	°C/W			280	

Test Conditions: V_S = 8 V, I_D = 40 mA Typ., OIP₃ Tone Spacing = 1.2 MHz, Pout per tone = 0 dBm
R_{BIAS} = 110 Ohms, T_L = 25°C, Z_S = Z_L = 50 Ohms, [1] 100% DC Tested, [2] Sample Tested

The information provided herein is believed to be reliable at press time. Sirenza Microdevices assumes no responsibility for inaccuracies or omissions. Sirenza Microdevices assumes no responsibility for the use of this information, and all such information shall be entirely at the user's own risk. Prices and specifications are subject to change without notice. No patent rights or licenses to any of the circuits described herein are implied or granted to any third party. Sirenza Microdevices does not authorize or warrant any Sirenza Microdevices product for use in life-support devices and/or systems. Copyright 2007 Sirenza Microdevices, Inc.. All worldwide rights reserved.

303 South Technology Court
Broomfield, CO 80021

Phone: (800) SMI-MMIC

<http://www.sirenza.com>

Typical Performance at 25° C (V_{ds} = 3.8V, I_{ds} = 40mA)
 (data includes bond wires)

|S11| vs. Frequency

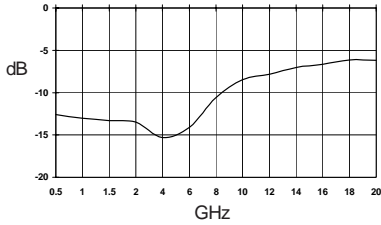

|S21| vs. Frequency

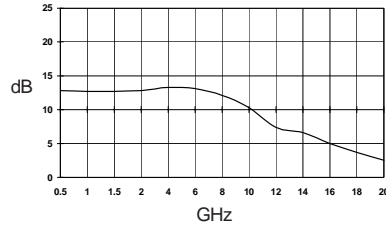

|S12| vs. Frequency

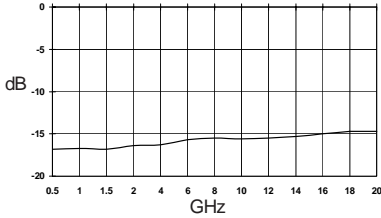

|S22| vs. Frequency

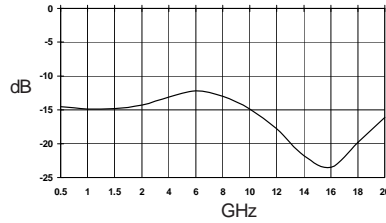

Noise Figure vs. Frequency

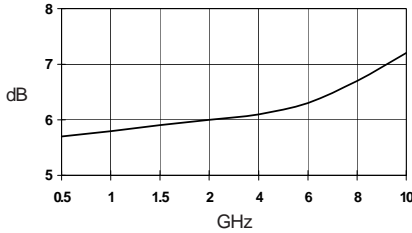

TOIP vs. Frequency

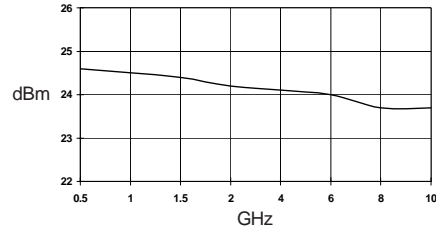

Absolute Maximum Ratings

Parameter	Absolute Limit
Max. Device Current (I _b)	90 mA
Max. Device Voltage (V _b)	6 V
Max. RF Input Power	+20 dBm
Max. Junction Temp. (T _j)	+200°C
Operating Temp. Range (T _l)	-40°C to +85°C
Max. Storage Temp.	+150°C

Operation of this device beyond any one of these limits may cause permanent damage. For reliable continuous operation, the device voltage and current must not exceed the maximum operating values specified in the table on page one.

Bias Conditions should also satisfy the following expression:
 $I_b V_D < (T_j - T_L) / R_{th(j-l)}$



SNA-100S DC-10 GHz Cascadable MMIC Amplifier

Typical Application Circuit

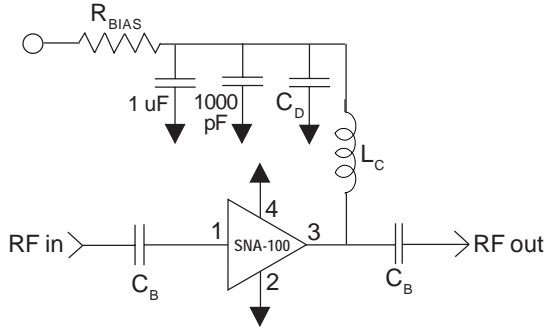

Application Circuit Element Values

Reference Designator	Frequency (Mhz)				
	500	850	1950	2400	3500
C _B	220 pF	100 pF	68 pF	56 pF	39 pF
C _D	100 pF	68 pF	22 pF	22 pF	15 pF
L _C	68 nH	33 nH	22 nH	18 nH	15 nH

Recommended Bias Resistor Values for I_D = 40mA

$$R_{BIAS} = (V_S - V_D) / I_D$$

Supply Voltage (V _S)	6V	8V	10V	12V
R _{BIAS}	60Ω	110Ω	160Ω	210Ω

Note: R_{BIAS} provides DC bias stability over temperature.

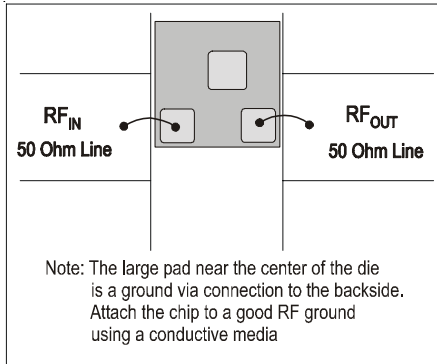

Suggested Bonding Arrangement
(above configuration used for S-parameter data)

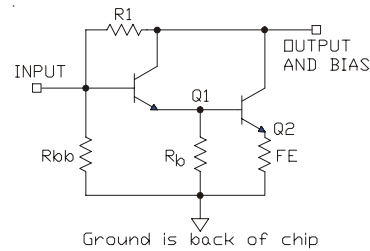
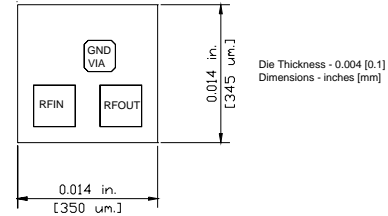

Simplified Schematic of MMIC

For recommended handling, die attach, and bonding methods, see the following application note at www.sirenza.com.

AN-041 (PDF) Handling of Unpackaged Die



Caution: ESD sensitive

Appropriate precautions in handling, packaging and testing devices must be observed.

Part Number Ordering Information

Part Number	Gel Pack
SNA-100	100 pcs. per pack

Die are shipped per Sirenza application note AN-039 Visual Criteria For Unpackaged Die