

**LA3335M**
**PLL FM Multiplex Demodulator
for 3 V Headphone Stereos and
Radio-cassette Recorders**

Overview

The LA3335M is PLL FM stereo multiplex demodulator IC designed for use in headphone stereos, etc. which operate from a low supply voltage.

Applications

- FM Multiplex IC for 3 V headphones, radio-cassette recorders

Functions

- PLL FM stereo decoder, VCO stop, stereo indicator

Features

- Wide operating voltage range : 1.8 to 6 V
- Low current dissipation : 1.6 mA
- Minimum number of external parts required

Package Dimensions

unit : mm

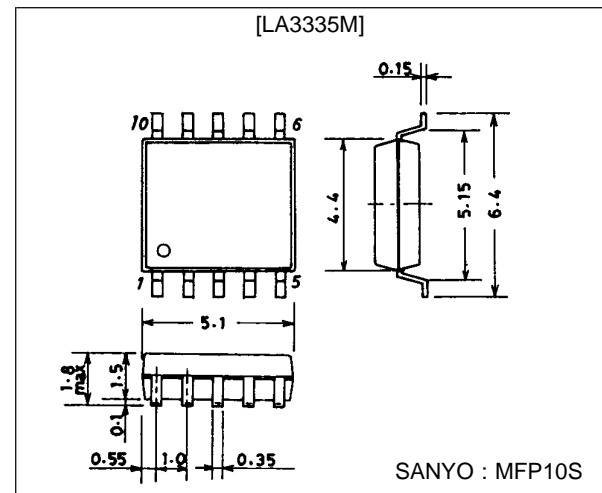
3086A-MFP10S

Specifications

Maximum Ratings at $T_a = 25\text{ }^\circ\text{C}$

Parameter	Symbol	Conditions	Ratings	Unit
Maximum supply voltage	$V_{CC\text{ max}}$		8	V
Lamp drive current	$I_L\text{ max}$		10	mA
Allowable power dissipation	$P_d\text{ max}$	$T_a \leq 70\text{ }^\circ\text{C}$	50	mW
Operating temperature	T_{op}		-20 to +70	$^\circ\text{C}$
Storage temperature	T_{stg}		-40 to +125	$^\circ\text{C}$

Operating Conditions at $T_a = 25\text{ }^\circ\text{C}$

Parameter	Symbol	Conditions	Ratings	Unit
Recommended supply voltage	V_{CC}		3	V
Operating voltage range	$V_{CC\text{ op}}$		1.8 to 6	V
Input signal voltage	V_{IN}		150	mV

SANYO Electric Co., Ltd. Semiconductor Business Headquarters

TOKYO OFFICE Tokyo Bldg., 1-10, 1 Chome, Ueno, Taito-ku, TOKYO, 110 JAPAN

O3096HA(II)/40594HK/O307TA, TS No.2619-1/6

LA3335M

Operating Characteristics at $T_a = 25\text{ }^\circ\text{C}$, $V_{CC} = 3\text{ V}$, input 150 mV , $L + R = 90\%$, pilot = 10% , $f = 1\text{ kHz}$, See specified Test Circuit.

Parameter	Symbol	Conditions	min	typ	max	Unit
Quiescent current	I_{CCO}	No input		1.6	2.5	mA
Input resistance	R_i		35	50	65	$k\Omega$
Output resistance	R_o		5.3	7.5	9.7	$k\Omega$
Channel separation	CHsep		30	45		dB
Total harmonic distortion	THD	Monaural		0.6	1.5	%
		Stereo main		0.3	1.5	%
Output voltage	V_O	Monaural	90	130	180	mV
Channel balance	CB	Monaural		0	1.5	dB
Lamp lighting level	V_L	Pilot	1.5	3.5	6	mV
Lamp hysteresis	hy			3.5		dB
Capture range	CR	Pilot 15 mV		± 3		%
Allowable input level	$V_{IN\text{ max}}$	Monaural, THD = 5%		350		mV
Signal to noise ratio	S/N	Monaural		82		dB

Equivalent Circuit Block Diagram and Test Circuit

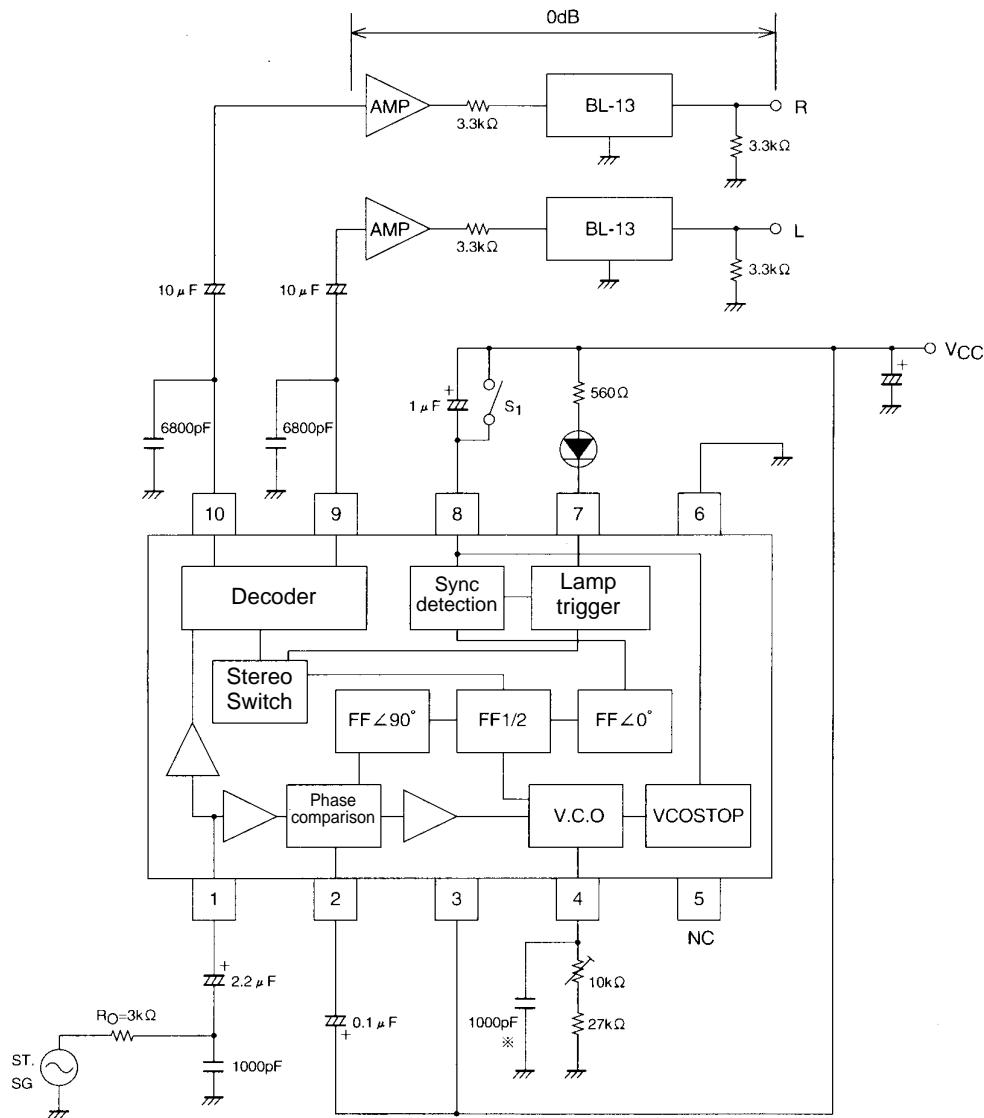

S1: VCO STOP when ON

AMP: Bandwidth of 100 kHz or more, THD = 0.01% or less, input impedance of 330 $k\Omega$ or more

* Styrol capacitor

A06081

LA3335M

External Parts

Part Name	Symbol	Kind	Value	Remarks
Resistor	R1	Carbon resistor	27 k Ω	VCO time constant
	R2	Carbon resistor	560 Ω	Limiting resistor
Semifixed resistor	VR1	Carbon resistor	10 k Ω	VCO OSC frequency adjust
Capacitor	C1	Electrolytic capacitor	2.2 μ F	DC blocking
	C2	Electrolytic capacitor	0.1 μ F	Loop filter
	C3	Polystyrol capacitor	1000 pF	VCO time constant
	C4	Electrolytic capacitor	1 μ F	Pilot detection
	C5	Ceramic capacitor	6800 pF	De-emphasis
	C6	Ceramic capacitor	6800 pF	De-emphasis
	C7	Electrolytic capacitor		Power supply ripple filter

Typical Voltage and Name of Each Pin

Pin No.	Voltage	Name	Remarks
1	1.2 V	Input	
2	$V_{CC}-0.7$ V	PLL loop filter	
3	V_{CC}	Power supply	
4	—	VCO	 $V_{CC}-0.2$ V $0.65 V_{CC}$
5	—	NC	
6	0 V	GND	
7	—	Stereo indicator	Open collector
8	$V_{CC}-0.7$ V	Pilot sync detection filter	
9	1.3 V	Decoder output (low)	
10	1.3 V	Decoder output (high)	

Proper cares in using IC

1. VCO stop method
Short pin 7 and pin 3 (V_{CC} pin) to stop the VCO.
(Note) The maximum voltage to be applied to pin 7 must not exceed the voltage on pin 3.
2. Free-running frequency check method : Use either of the following two methods.
 - a) Connect pin 4 to a frequency counter through the high input impedance amplifier.

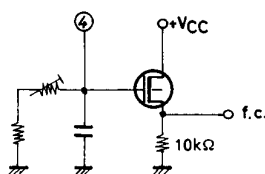

Figure 1

LA3335M

- b) Connect the connection point of the semifixed resistor connected to pin 4 and the fixed resistor to a frequency counter through the R_X of 240 k Ω . Fig. 2 shows how the error changes as the R_X value is decreased.

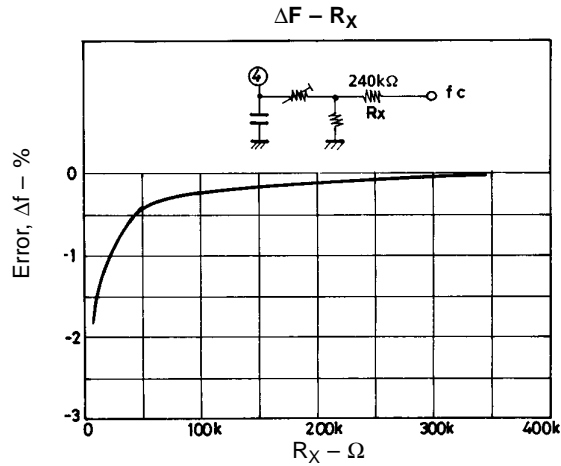

Figure 2

3. Separation setting method

The LA3335M is so designed that the sub-signal gain is approximately 1.25 times as high as the main signal gain. The separation can be set by attenuating the sub-signal of the FM detection output. (See Figure 3)

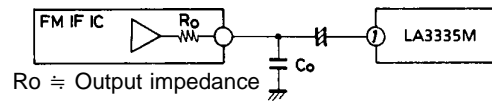

Figure 3

The value of capacitor C_o depends on the attenuation of the sub-signal of the FM detection output and the IF IC output impedance R_o . Fig. 4 shows the value of separation setting capacitor C_o when R_o is set to 3 k Ω .

For example, when the attenuation of sub-signal of the IF IC output is 0.9 time that of the main signal, it is seen from Figure 4 that the value of C_o is approximately 500 pF.

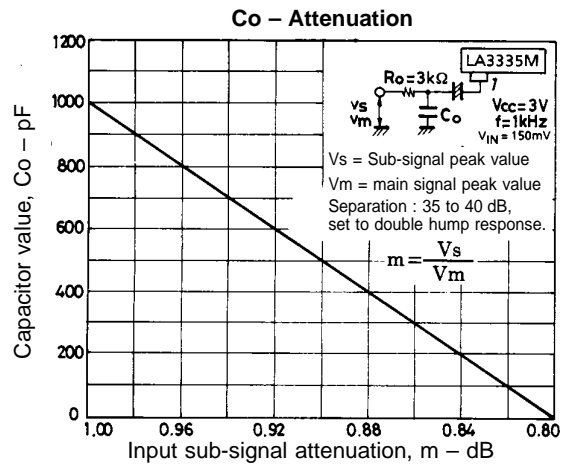
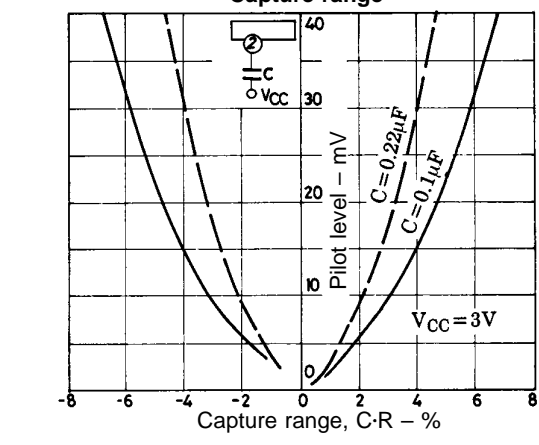
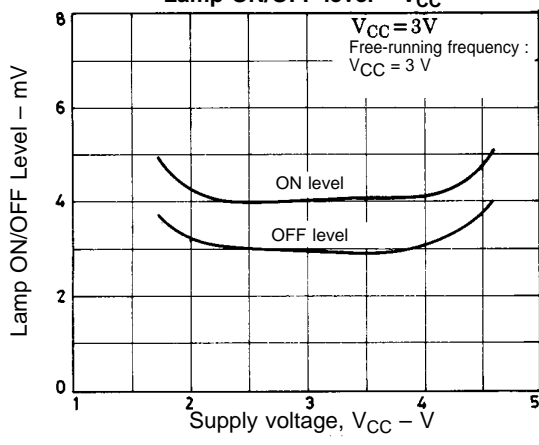
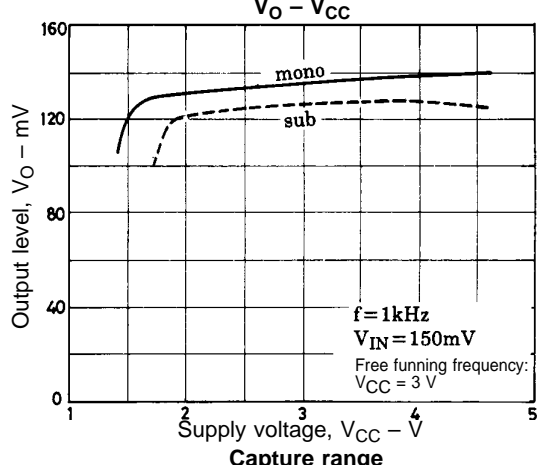
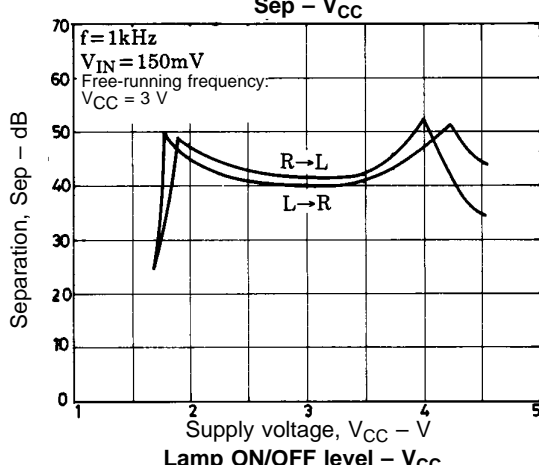
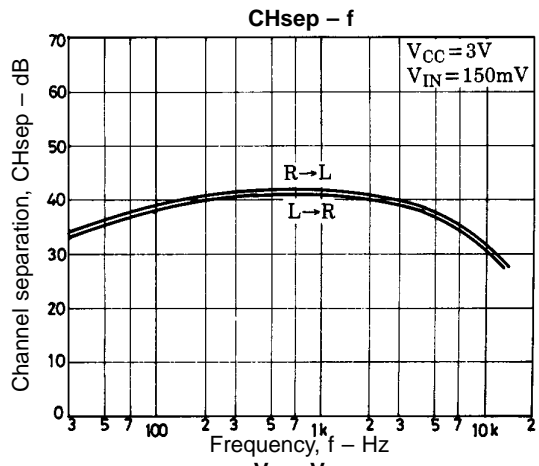
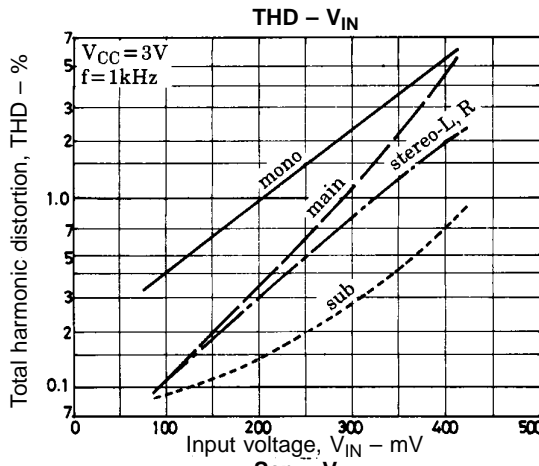
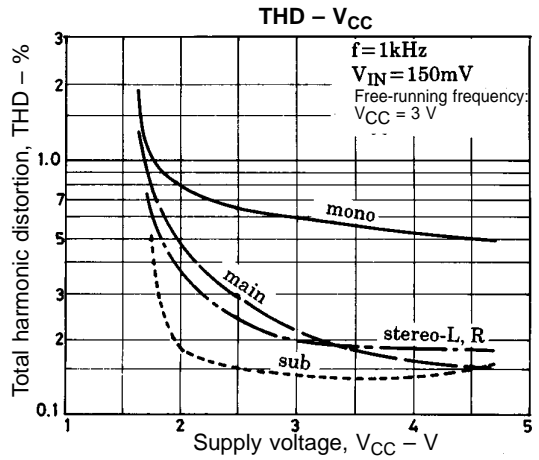
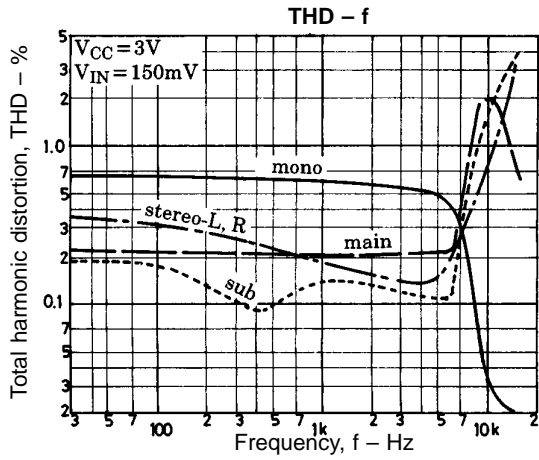
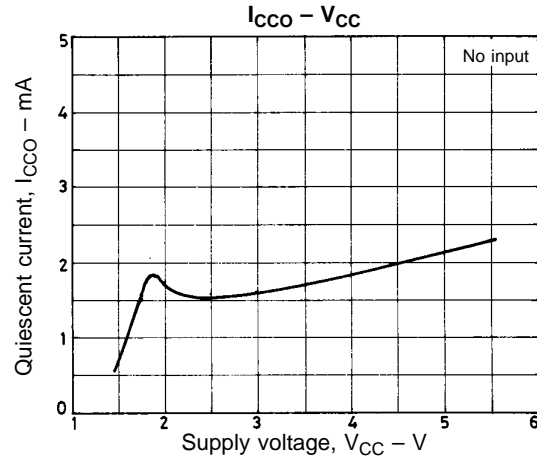
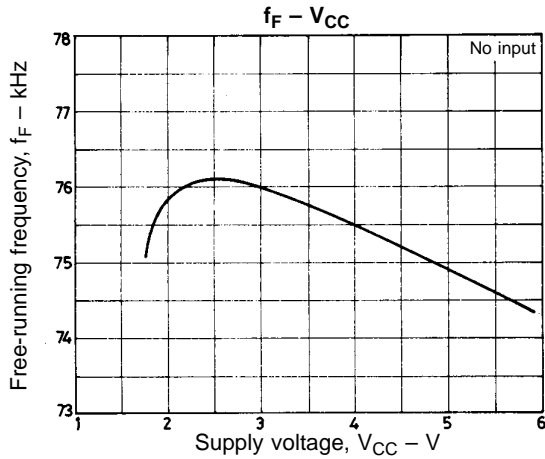

Figure 4





- No products described or contained herein are intended for use in surgical implants, life-support systems, aerospace equipment, nuclear power control systems, vehicles, disaster/crime-prevention equipment and the like, the failure of which may directly or indirectly cause injury, death or property loss.
- Anyone purchasing any products described or contained herein for an above-mentioned use shall:
 - ① Accept full responsibility and indemnify and defend SANYO ELECTRIC CO., LTD., its affiliates, subsidiaries and distributors and all their officers and employees, jointly and severally, against any and all claims and litigation and all damages, cost and expenses associated with such use:
 - ② Not impose any responsibility for any fault or negligence which may be cited in any such claim or litigation on SANYO ELECTRIC CO., LTD., its affiliates, subsidiaries and distributors or any of their officers and employees jointly or severally.
- Information (including circuit diagrams and circuit parameters) herein is for example only; it is not guaranteed for volume production. SANYO believes information herein is accurate and reliable, but no guarantees are made or implied regarding its use or any infringements of intellectual property rights or other rights of third parties.

This catalog provides information as of October, 1996. Specifications and information herein are subject to change without notice.