

# SKKD 81, SKKE 81



**SEMIPACK® 1**

$V_{RSM}$ V	$V_{RRM}$ V	$I_{FRMS} = 140$ A (maximum value for continuous operation) $I_{FAV} = 80$ A (sin. 180; $T_c = 87$ °C)	
500	400	SKKE 81/04	SKKD 81/04
700	600	SKKE 81/06	SKKD 81/06
900	800	SKKE 81/08	SKKD 81/08
1300	1200	SKKE 81/12	SKKD 81/12
1500	1400	SKKE 81/14	SKKD 81/14
1700	1600	SKKE 81/16	SKKD 81/16
1900	1800	SKKE 81/18	SKKD 81/18
2100	2000	SKKE 81/20H4	SKKD 81/20H4
2300	2200	SKKE 81/22H4	SKKD 81/22H4

## Rectifier Diode Modules

**SKKD 81**

**SKKE 81**

### Features

- Heat transfer through aluminium oxide ceramic isolated metal baseplate
- Hard soldered joints for high reliability
- UL recognized, file no. E 63 532

### Typical Applications

- Non-controllable rectifiers for AC/AC converters
- Line rectifiers for transistorized AC motor controllers
- Field supply for DC motors
- Free-wheeling diodes

1) SKKD types only

Symbol	Conditions	Values	Units
$I_{FAV}$	sin. 180; $T_c = 85$ (100) °C	82 (57)	A
$I_D$	P3/120; $T_a = 45$ °C; B2 / B6	63 / 70	A
	P3/180F; $T_a = 35$ °C; B2 / B6	135 / 175	A
$I_{FSM}$	$T_{vj} = 25$ °C; 10 ms	2000	A
	$T_{vj} = 125$ °C; 10 ms	1750	A
$i^2t$	$T_{vj} = 25$ °C; 8,3 ... 10 ms	20000	A <sup>2</sup> s
	$T_{vj} = 125$ °C; 8,3 ... 10 ms	15000	A <sup>2</sup> s
$V_F$	$T_{vj} = 25$ °C; $I_F = 300$ A	max. 1,55	V
$V_{(TO)}$	$T_{vj} = 125$ °C	max. 0,85	V
$r_T$	$T_{vj} = 125$ °C	max. 1,8	mΩ
$I_{RD}$	$T_{vj} = 125$ °C; $V_{RD} = V_{RRM}$	max. 4,5	mA
$R_{th(j-c)}$	per diode / per module <sup>1)</sup>	0,4 / 0,2	K/W
$R_{th(c-s)}$	per diode / per module <sup>1)</sup>	0,2 / 0,1	K/W
$T_{vj}$		- 40 ... + 125	°C
$T_{stg}$		- 40 ... + 125	°C
$V_{isol}$	a. c. 50 Hz; r.m.s.; 1 s / 1 min.	3600 / 3000	V~
$V_{isol}$	a. c. 50 Hz; r.m.s.; 1 s / 1 min. for SKK...H4	4800 / 4000	V~
$M_s$	to heatsink	5 ± 15 %	Nm
$M_t$	to terminals	3 ± 15 %	Nm
a		5 * 9,81	m/s <sup>2</sup>
m	approx.	95	g
Case	SKKD	A 10	
	SKKE	A 12	

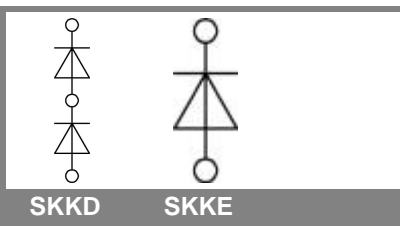

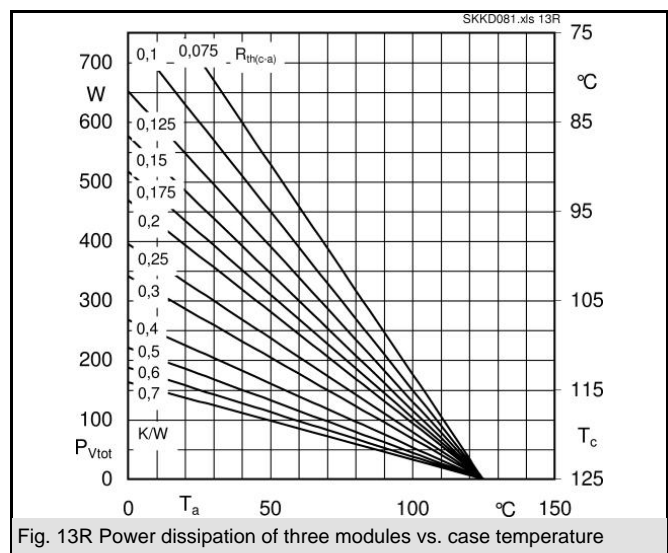
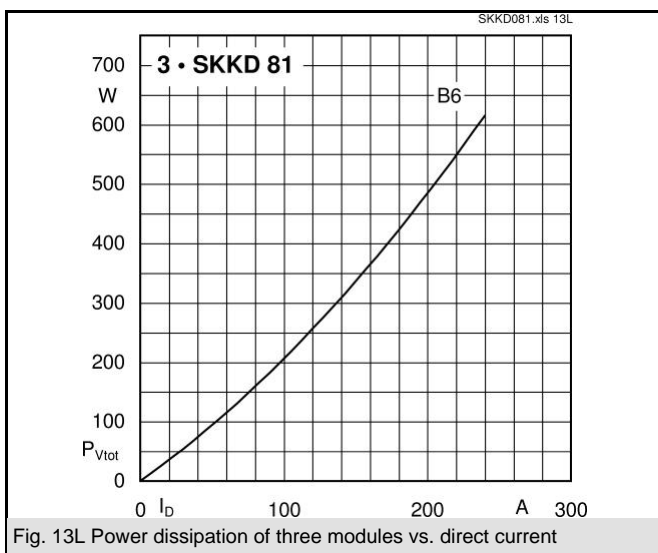
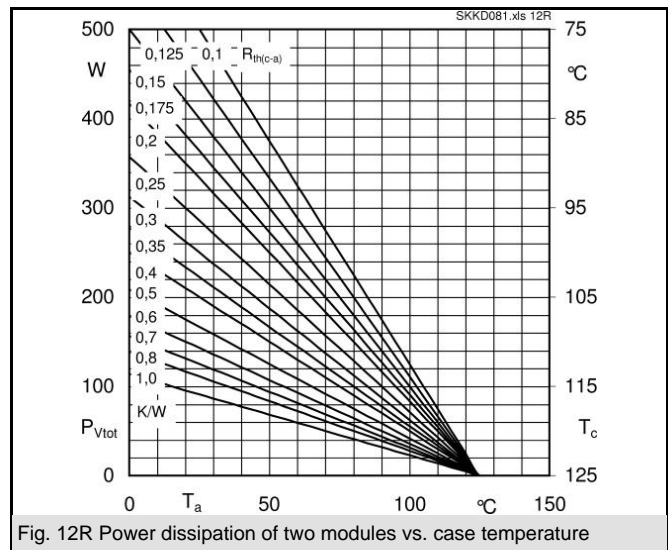
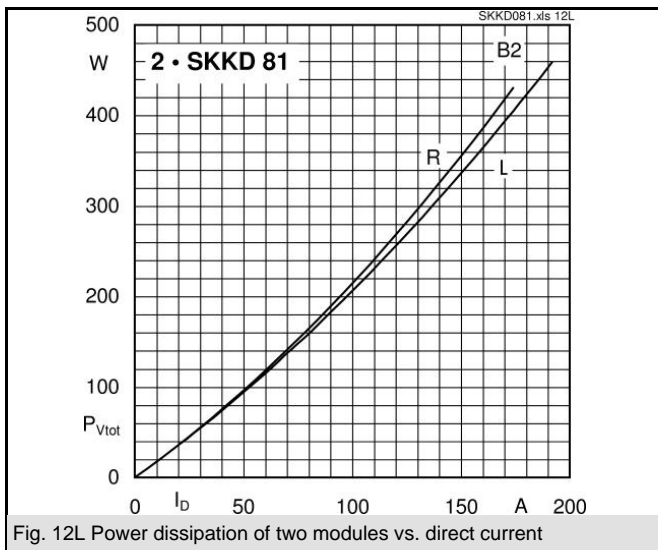
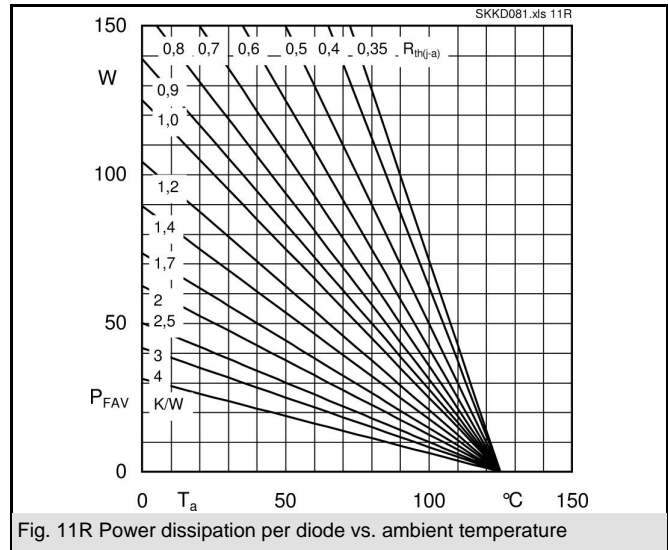
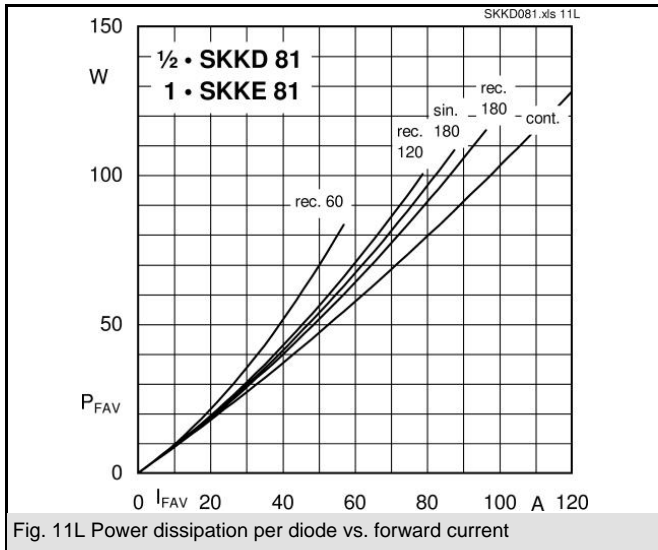

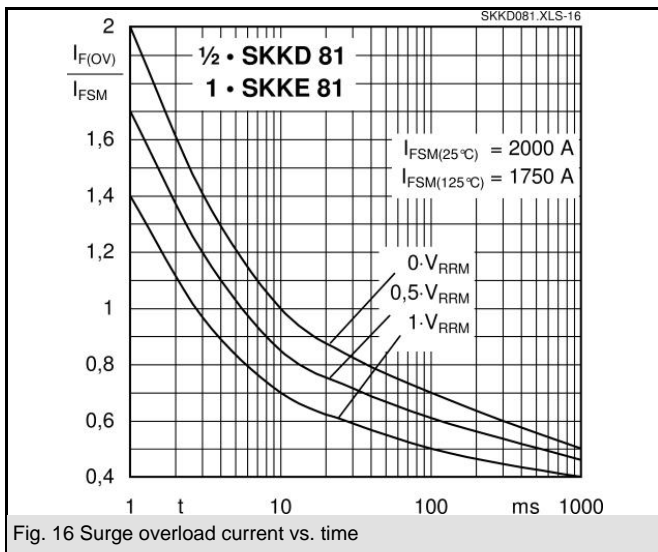
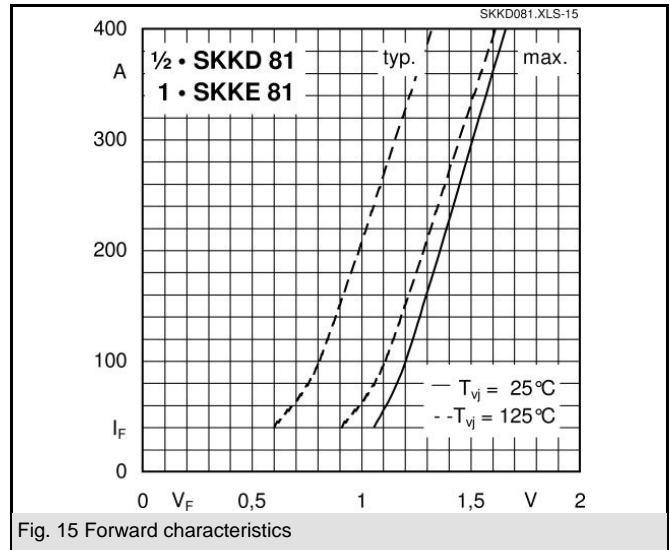
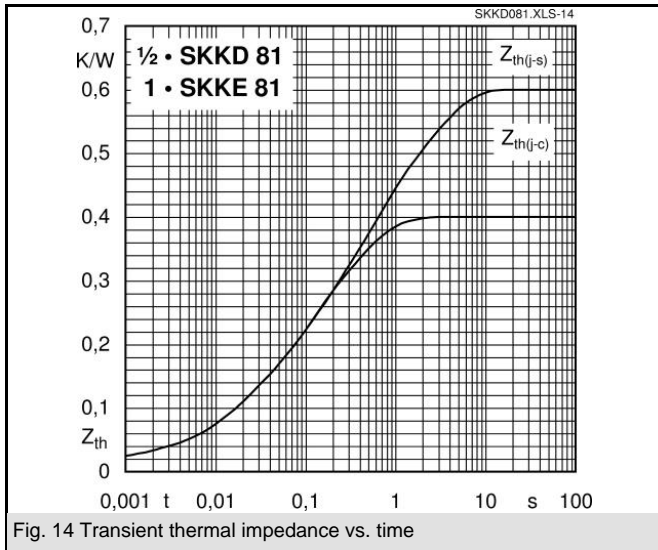

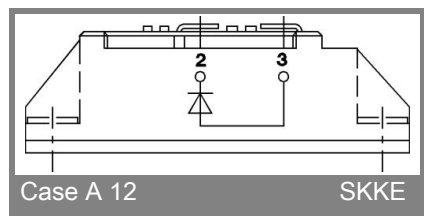
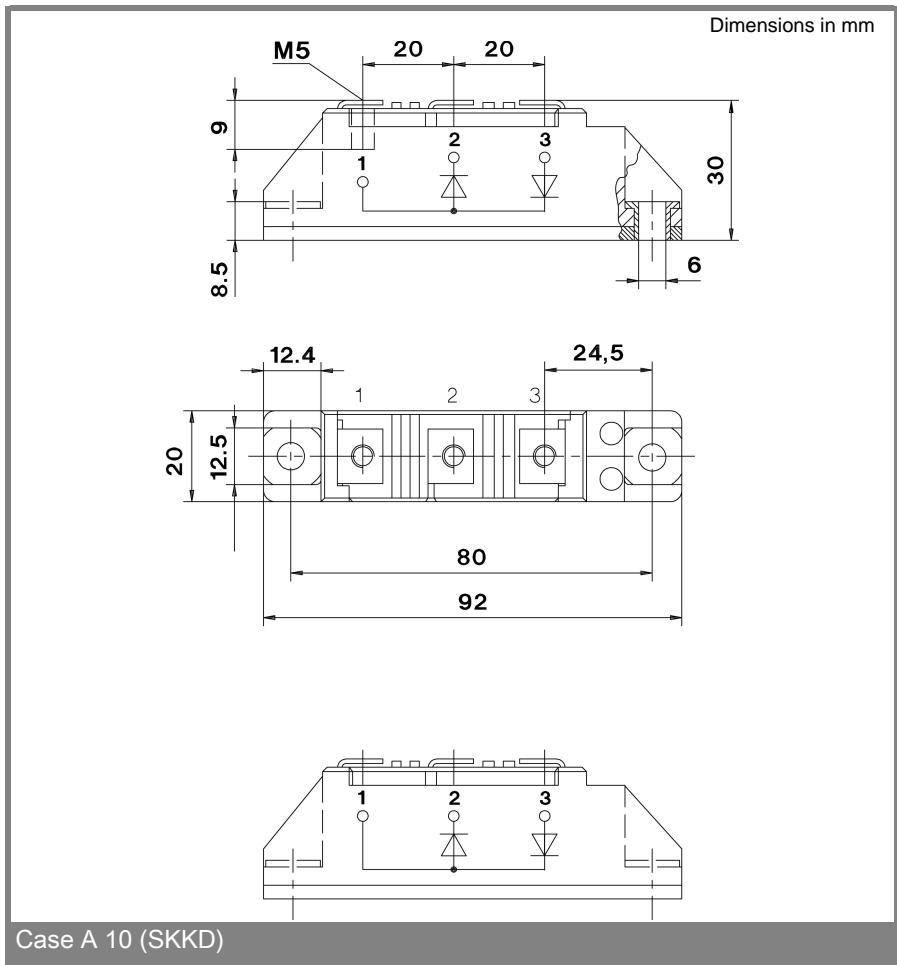

This technical information specifies semiconductor devices but promises no characteristics. No warranty or guarantee expressed or implied is made regarding delivery, performance or suitability.