

SKKD 260



SEMIPACK® 3

Rectifier Diode Modules

SKKD 260

Features

- Heat transfer through aluminium nitride ceramic isolated metal baseplate
- Precious metal pressure contacts
- UL recognized, file no. E 63 532

Typical Applications

- Non-controllable rectifiers for AC/AC converters
- Line rectifiers for transistorized AC motor controllers
- Field supply for DC motors

1) The screws must be lubricated

| V_{RSM} V | V_{RRM} V | $I_{FRMS} = 410$ A (maximum value for continuous operation) $I_{FAV} = 260$ A (sin. 180; $T_c = 85$ °C) | | |
|----------------|----------------|--|--|--|
| 900 | 800 | SKKD 260/08 | | |
| 1300 | 1200 | SKKD 260/12 | | |
| 1500 | 1400 | SKKD 260/14 | | |
| 1700 | 1600 | SKKD 260/16 | | |
| 2100 | 2000 | SKKD 260/20H4 | | |
| 2300 | 2200 | SKKD 260/22H4 | | |

| Symbol | Conditions | Values | Units |
|---------------|---|------------------------|------------------|
| I_{FAV} | sin. 180; $T_c = 85$ (100) °C | 260 (185) | A |
| I_D | P3/180F; $T_a = 35$ °C; B2 / B6 | 280 / 320 | A |
| | P3/180F; $T_a = 35$ °C; B2 / B6 | 490 / 655 | A |
| I_{FSM} | $T_{vj} = 25$ °C; 10 ms | 11000 | A |
| | $T_{vj} = 130$ °C; 10 ms | 10000 | A |
| i^2t | $T_{vj} = 25$ °C; 8,3 ... 10 ms | 605000 | A ² s |
| | $T_{vj} = 130$ °C; 8,3 ... 10 ms | 500000 | A ² s |
| V_F | $T_{vj} = 25$ °C; $I_F = 750$ A | max. 1,25 | V |
| $V_{(TO)}$ | $T_{vj} = 130$ °C | max. 0,9 | V |
| r_T | $T_{vj} = 130$ °C | max. 0,37 | mΩ |
| I_{RD} | $T_{vj} = 130$ °C; $V_{RD} = V_{RRM}$ | max. 15 | mA |
| $R_{th(j-c)}$ | cont.; per diode / per module | 0,14 / 0,07 | K/W |
| | sin. 180; per diode / per module | 0,15 / 0,075 | K/W |
| $R_{th(c-s)}$ | per diode / per module | 0,04 / 0,02 | K/W |
| T_{vj} | | - 40 ... + 130 | °C |
| T_{stg} | | - 40 ... + 130 | °C |
| V_{isol} | a. c. 50 Hz; r.m.s.; 1 s / 1 min. | 3600 / 3000 | V~ |
| V_{isol} | a. c. 50 Hz; r.m.s.; 1 s / 1 min. for SKK ...H4 | 4800 / 4000 | V~ |
| M_s | to heatsink | 5 ± 15 % | Nm |
| M_t | to terminals | 9 ± 15 % ¹⁾ | Nm |
| a | | 5 * 9,81 | m/s ² |
| m | approx. | 600 | g |
| Case | | A 78b | |

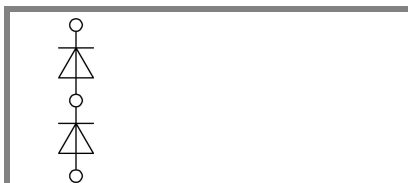

SKKD

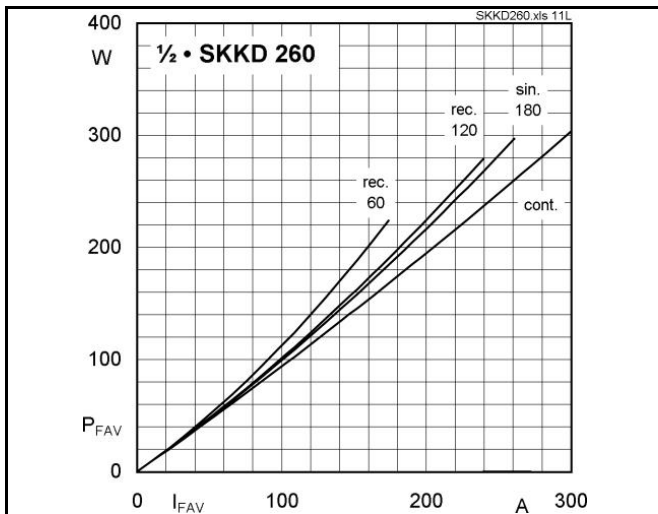

Fig. 11L Power dissipation per diode vs. forward current

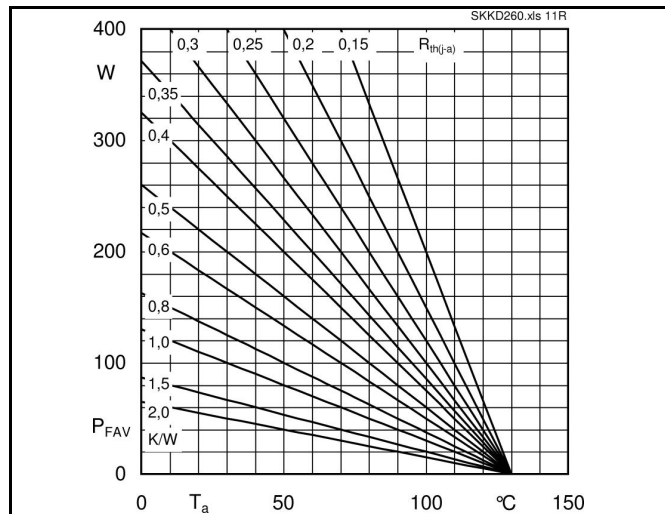

Fig. 11R Power dissipation per diode vs. ambient temperature

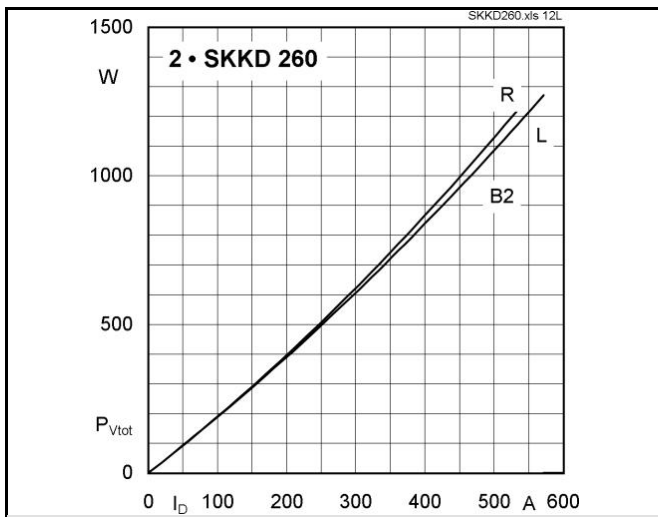

Fig. 12L Power dissipation of two modules vs. direct current

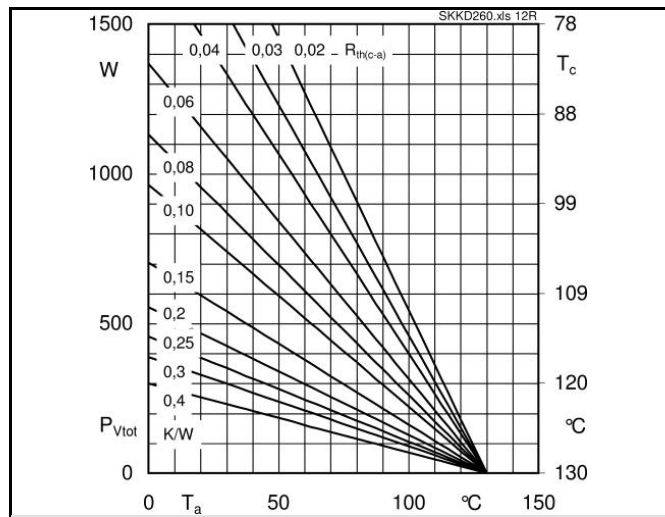

Fig. 12R Power dissipation of two modules vs. case temperature

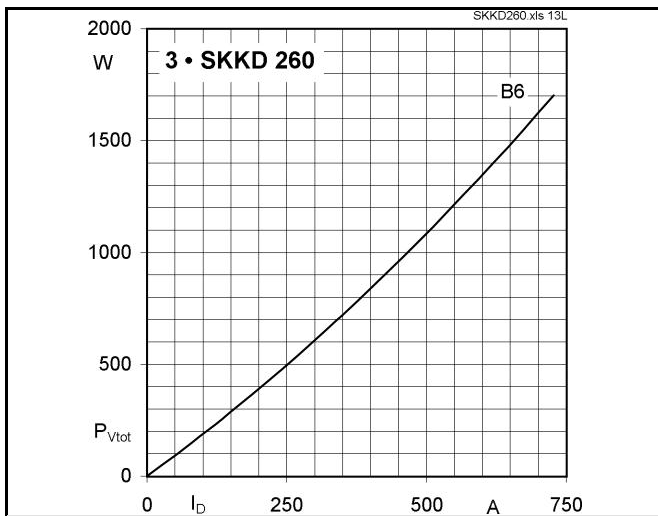

Fig. 13L Power dissipation of three modules vs. direct current

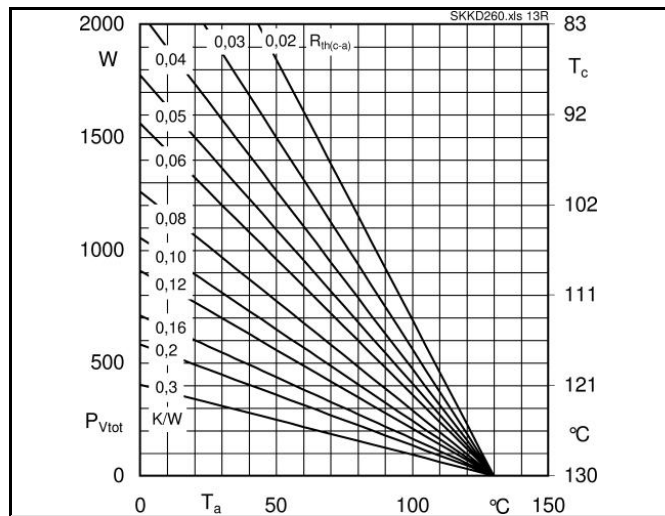

Fig. 13R Power dissipation of three modules vs. case temperature

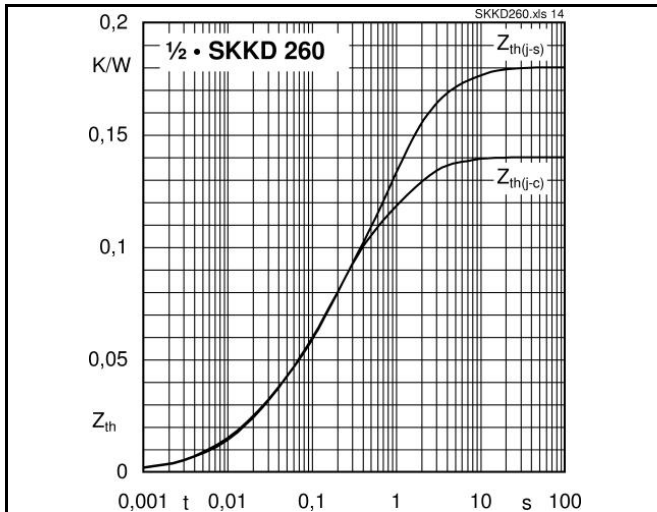

Fig. 14 Transient thermal impedance vs. time

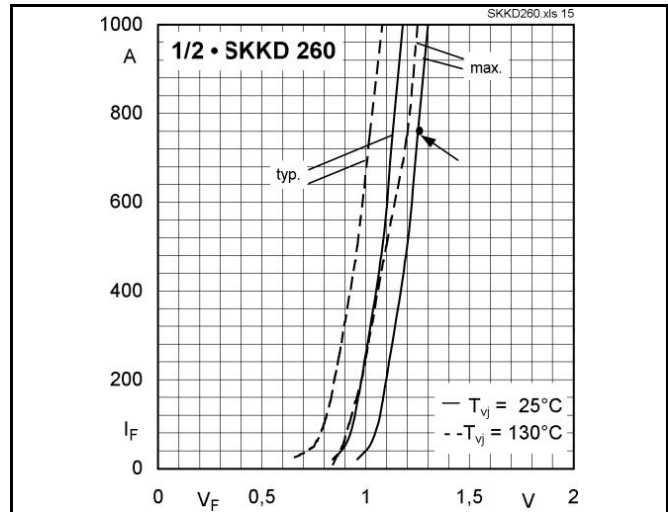

Fig. 15 Forward characteristics

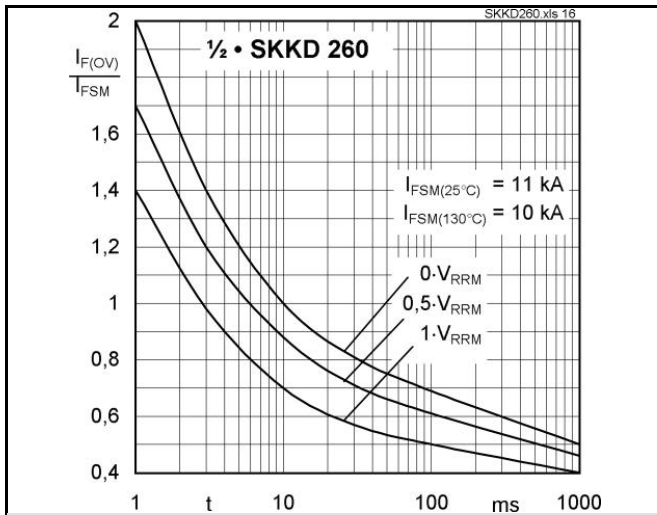
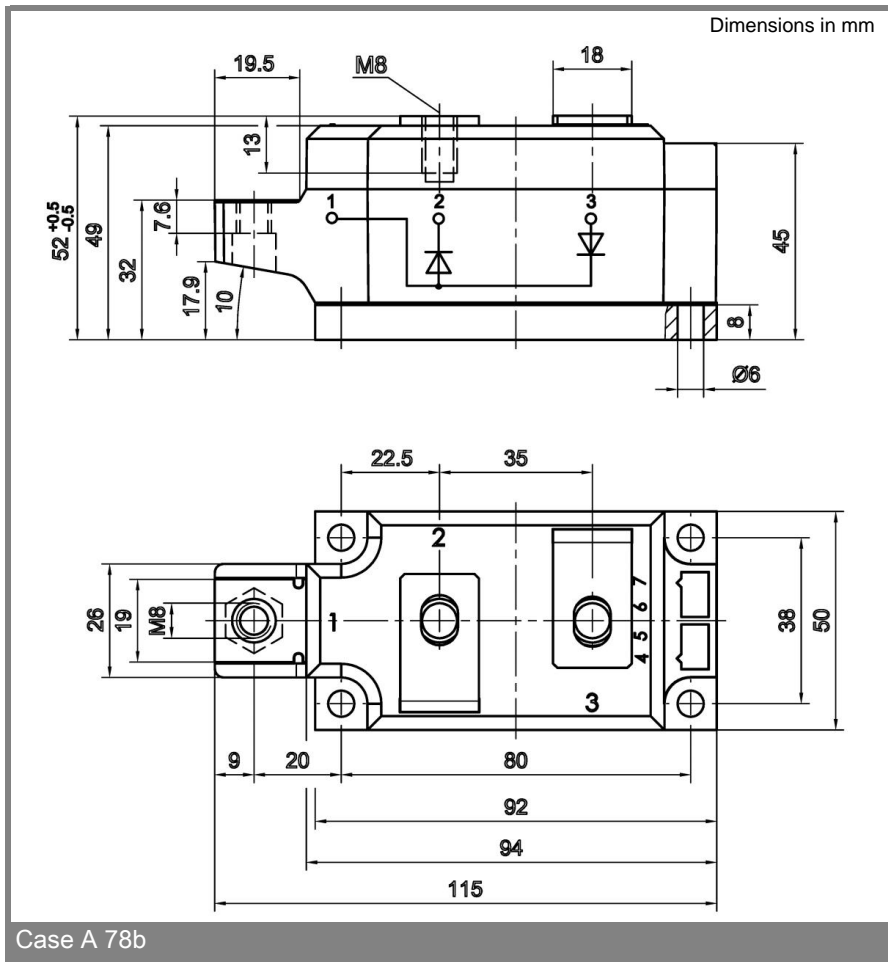

Fig. 16 Surge overload current vs. time

SKKD 260



This technical information specifies semiconductor devices but promises no characteristics. No warranty or guarantee expressed or implied is made regarding delivery, performance or suitability.