

Chip Inductors

Japan

Series: **Chip**

Type: **RF, RE, ND, NC, NA, FC, FA, FB, SA, PE, PC, PA, EA**

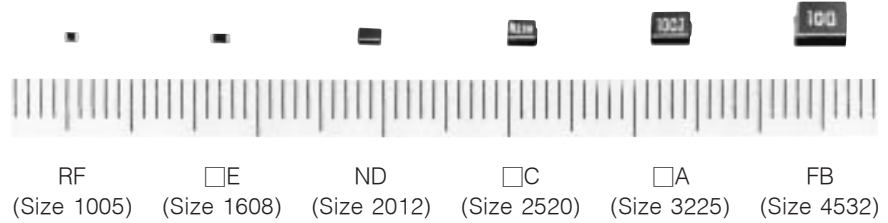

Non winding (RF, E) and wire wound type chip inductors for automatic mounting and high-density mounting

Industrial Property: Patents 6 (incl. pending)

■ Features

- High Q
- Good for mounting
- Wide allowable range (1.0 nH to 1000 μ H)

■ Recommended Applications

- CTV, VTR, HIC, HDD, FDD, Cordless telephones, Portable telephones
Pagers, Video cameras

■ Explanation of Part Numbers

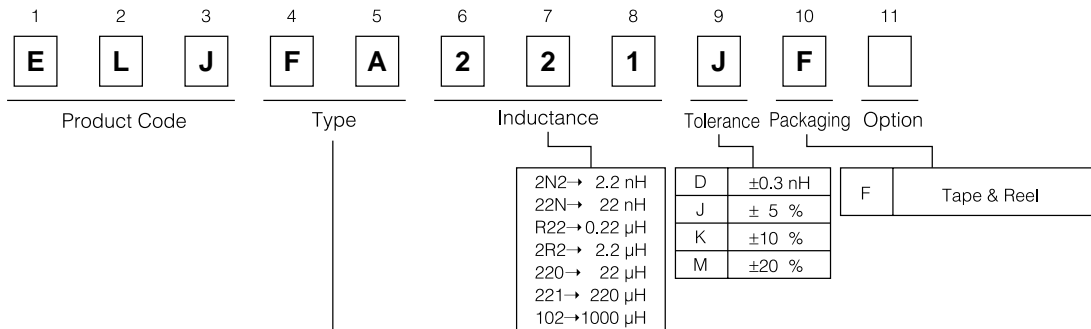

Types \ Styles	F	E	D	C	A	B
	1005 (0402)	1608 (0603)	2012 (0805)	2520 (1008)	3225 (1210)	4532 (1812)
Non Magnetic Core	RF	RE	ND	NC	NA	-
Regular	-	-	-	FC	FA	FB
Shield	-	-	-	-	SA	-
High Power	-	PE	-	PC	PA	-
Low DC resistance	-	-	-	-	EA	-

Size unit: mm

Design, Specifications are subject to change without notice. Ask factory for technical specifications before purchase and/or use. Whenever a doubt about safety arises from this product, please inform us immediately for technical consultation without fail.

Inductance, Size Guide

	Type NAME	L VALUE						Features
		0.001	0.01	0.1	1.0	10	100	
Non Magnetic Core	1005 (0402) RF							Low inductance, tight tolerance Stable L value against an environ- mental condition Suitable for high frequency circuits
	1608 (0603) RE							
	2012 (0805) ND							
	2520 (1008) NC							
	3225 (1210) NA							
Regular	2520 (1008) FC							Suitable for various applications
	3225 (1210) FA							
	3225 (1210) SA Mag. shield							
	4532 (1812) FB							
High Power	1608 (0603) PE NEW							Large DC current Suitable for power line as choke coil
	2520 (1008) PC							
	3225 (1210) PA							
Low DC resistance	3225 (1210) EA NEW							Low DC resistance

Size unit : mm

Design, Specifications are subject to change without notice. Ask factory for technical specifications before purchase and/or use. Whenever a doubt about safety arises from this product, please inform us immediately for technical consultation without fail.

1. Non Magnetic Core Types RF, RE, ND, NC, NA

■ Examples : Type 1005(0402)RF

Part No.	Inductance		Q min.	L,Q Test-Freq. (MHz)	Q Typical (800 MHz)	SRF.*1 min.(MHz)	DCR.*2 max.(Ω)	DC current max.(mA)
	nH	Tolerance						
ELJRF1N0DF2	1.0	±0.3 nH	8	100	21	6000	0.05	400
ELJRF1N2DF2	1.2				21	6000	0.06	400
ELJRF1N5DF2	1.5				21	6000	0.07	400
ELJRF1N8DF2	1.8				21	6000	0.08	400
ELJRF2N2DF2	2.2				21	6000	0.09	400
ELJRF2N7DF2	2.7				21	5500	0.10	400
ELJRF3N3DF2	3.3				21	5500	0.12	400
ELJRF3N9DF2	3.9				20	5200	0.15	360
ELJRF4N7DF2	4.7				20	4800	0.17	360
ELJRF5N6DF2	5.6				20	4600	0.19	340
ELJRF6N8JF2	6.8	± 5 %	8	100	19	4000	0.30	320
ELJRF8N2JF2	8.2				19	3500	0.35	320
ELJRF10NJF2	10				19	2800	0.41	320
ELJRF12NJF2	12				19	2800	0.45	320
ELJRF15NJF2	15				19	2500	0.60	240
ELJRF18NJF2	18				19	2200	0.70	240
ELJRF22NJF2	22				19	2000	0.80	200
ELJRF27NJF2	27				19	1800	1.2	200
ELJRF33NJF2	33				18	1800	1.4	170
ELJRF39NJF2	39				18	1800	1.7	150
ELJRF47NJF2	47	17	1800	2.1	140			
ELJRF56NJF2	56	17	1500	2.5	130			
ELJRF68NJF2	68	15	1500	4.0	120			
ELJRF82NJF2	82	15	1400	4.5	110			
ELJRFR10JF2	100	14	1200	5.5	90			

*1 : Self Resonant Frequency *2 : DC Resistance

■ Performance Characteristics

Type: 1005 (0402) RF

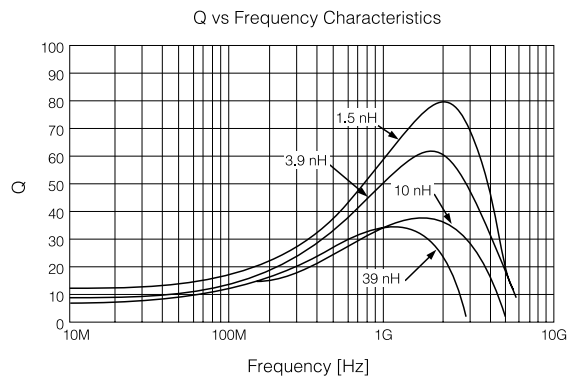
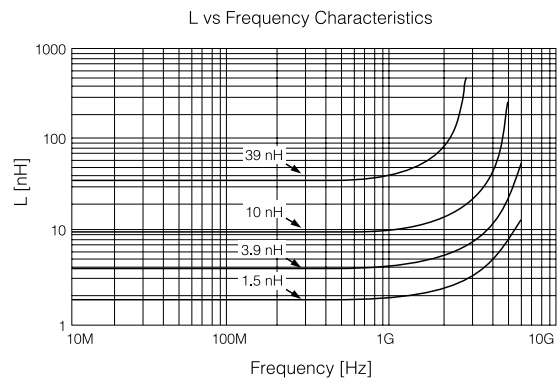

Design, Specifications are subject to change without notice. Ask factory for technical specifications before purchase and/or use. Whenever a doubt about safety arises from this product, please inform us immediately for technical consultation without fail.

■ Examples : Type 1608(0603)RE

Part No.	Inductance		Q min.	L, Q Test-Freq. (MHz)	Q Typical (800 MHz)	SRF*1 min.(MHz)	DCR*2 max.(Ω)	DC Current max.(mA)
	nH	Tolerance						
ELJRE1N0DF2	1.0	±0.3 nH	7	100	47	6000	0.05	500
ELJRE1N2DF2	1.2				47	6000	0.06	500
ELJRE1N5DF2	1.5		47		6000	0.07	500	
ELJRE1N8DF2	1.8		8		45	6000	0.08	500
ELJRE2N2DF2	2.2				35	6000	0.09	500
ELJRE2N7DF2	2.7		35		6000	0.10	500	
ELJRE3N3DF2	3.3	± 5 %	9		35	5500	0.12	500
ELJRE3N9JF2	3.9				36	5500	0.15	450
ELJRE4N7JF2	4.7				36	4800	0.17	450
ELJRE5N6JF2	5.6				36	4600	0.18	430
ELJRE6N8JF2	6.8				36	3550	0.20	430
ELJRE8N2JF2	8.2				36	3500	0.28	400
ELJRE10NJF2	10		10		37	2800	0.32	400
ELJRE12NJF2	12				37	2800	0.35	400
ELJRE15NJF2	15				38	2500	0.41	350
ELJRE18NJF2	18				39	2300	0.45	350
ELJRE22NJF2	22				40	2000	0.50	300
ELJRE27NJF2	27				41	2000	0.55	300
ELJRE33NJF2	33	11	40		1800	0.60	300	
ELJRE39NJF2	39		39		1800	0.80	300	
ELJRE47NJF2	47		38		1800	0.95	250	
ELJRE56NJF3	56		12		35	1800	1.2	250
ELJRE68NJF3	68				35	1500	1.3	250
ELJRE82NJF3	82				33	1500	1.5	250
ELJRER10JF3	100	5	30	1300	1.8	200		
ELJRER12JF3	120		25.2	25	1200	3.0	130	
ELJRER15JF3	150			22	1100	4.5	100	
ELJRER18JF3	180		4	20	1000	6.5	80	
ELJRER22JF3	220			—	900	7.5	70	

*1 : Self Resonant Frequency *2 : DC Resistance

■ Q-Frequency Characteristics

Type: 1608 (0603) RE

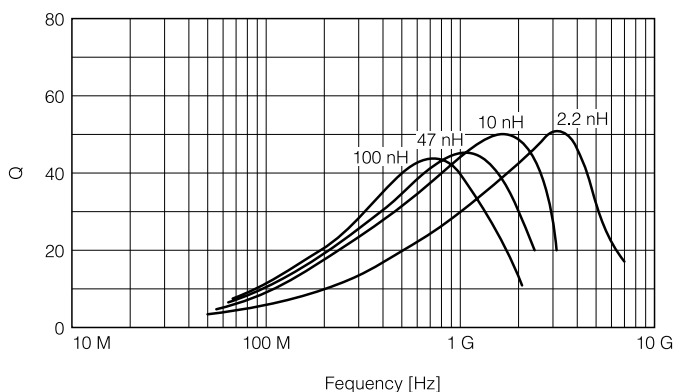

Design, Specifications are subject to change without notice. Ask factory for technical specifications before purchase and/or use. Whenever a doubt about safety arises from this product, please inform us immediately for technical consultation without fail.

Examples : Type 2012(0805)ND

Part No.	Inductance		Q min.	L, Q Test-Freq. (MHz)	Q Typical (800 MHz)	SRF*1 min.(MHz)	DCR*2 max.(Ω)	DC Current max.(mA)	
	nH	Tolerance							
ELJND10NKF	10	± 10 %	10	100	72	3300	0.18	540	
ELJND12NKF	12				67	3300	0.24	535	
ELJND15NKF	15		12		73	3000	0.24	520	
ELJND18NKF	18				74	3000	0.29	480	
ELJND22NKF	22		15		75	2600	0.29	465	
ELJND27NKF	27				73	2500	0.34	455	
ELJND33NJ/KF	33	± 5 % ± 10 %	15	25.2	80	2050	0.39	395	
ELJND39NJ/KF	39				72	2000	0.41	390	
ELJND47NJ/KF	47		71		1650	0.46	385		
ELJND56NJ/KF	56		63		1550	0.51	360		
ELJND68NJ/KF	68		57		1450	0.57	340		
ELJND82NJ/KF	82		56		1100	0.63	330		
ELJNDR10J/KF	100		8		8	51	800	0.86	285
ELJNDR12J/KF	120					32	600	0.99	275
ELJNDR15J/KF	150		10		10	36	600	1.47	230
ELJNDR18J/KF	180					34	600	1.61	195
ELJNDR22J/KF	220	—		500		1.84	170		
ELJNDR27J/KF	270	—		300		1.95	165		
ELJNDR33J/KF	330	—		200		2.16	160		
ELJNDR39J/KF	390	—		150		2.37	150		
ELJNDR47J/KF	470	—		150		2.56	145		
ELJNDR56J/KF	560	—		100		2.69	140		
ELJNDR68J/KF	680	—		100		3.02	130		
ELJNDR82J/KF	820	—		80		3.38	125		
ELJND1R0J/KF	1000	8	7.96	—	80	3.88	120		

*1 : Self Resonant Frequency *2 : DC Resistance

Q-Frequency Characteristics

Type: 2012 (0805) ND

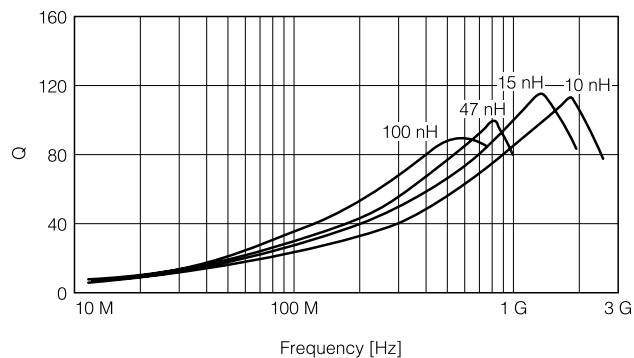

Design, Specifications are subject to change without notice. Ask factory for technical specifications before purchase and/or use. Whenever a doubt about safety arises from this product, please inform us immediately for technical consultation without fail.

■ Examples : Type 2520(1008)NC

Part No.	Inductance		Q min.	L, Q Test Freq.(MHz)	SRF *1 min.(MHz)	DCR *2 max.(Ω)	DC Current max.(mA)			
	nH	Tolerance								
ELJNC10NKF	10	±10 %	10	100	2500	0.32	280			
ELJNC12NKF	12				2200	0.34	270			
ELJNC15NKF	15				1800	0.38	255			
ELJNC18NKF	18				1550	0.40	250			
ELJNC22NKF	22				1350	0.43	240			
ELJNC27NKF	27				1150	0.47	230			
ELJNC33NK/JF	33	±10 % ± 5 %	15	100	1000	0.51	220			
ELJNC39NK/JF	39				890	0.55	215			
ELJNC47NK/JF	47				770	0.59	205			
ELJNC56NK/JF	56				670	0.63	200			
ELJNC68NK/JF	68				590	0.68	190			
ELJNC82NK/JF	82				520	0.73	185			
ELJNCR10K/JF	100				±10 % ± 5 %	10	25.2	460	0.80	175
ELJNCR12K/JF	120							400	0.87	170
ELJNCR15K/JF	150							340	0.98	160
ELJNCR18K/JF	180							300	1.05	155
ELJNCR22K/JF	220							260	1.15	145
ELJNCR27K/JF	270							230	1.25	140
ELJNCR33K/JF	330	200	1.37	135						
ELJNCR39K/JF	390	180	1.47	130						
ELJNCR47K/JF	470	160	1.58	125						
ELJNCR56K/JF	560	145	1.70	120						
ELJNCR68K/JF	680	130	1.85	110						
ELJNCR82K/JF	820	100	2.10	100						

*1 : Self Resonant Frequency *2 : DC Resistance

■ Examples : Type 3225(1210)NA

Part No.	Inductance			Q		SRF *1 min.(MHz)	DCR *2 max.(Ω)	DC Current max.(mA)				
	μH	Freq. (MHz)	Tolerance	min.	Freq. (MHz)							
ELJNA47NMF	0.047	100	±20 %	10	100	680	0.20	450				
ELJNA56NMF	0.056					600	0.22	420				
ELJNA68NMF	0.068					540	0.25	400				
ELJNA82NMF	0.082					500	0.27	380				
ELJNAR10MF	0.10					25.2	±10 %	10	25.2	450	0.30	360
ELJNAR12MF	0.12									400	0.67	240
ELJNAR15MF	0.15	350	0.72	230								
ELJNAR18MF	0.18	320	0.81	220								
ELJNAR22KF	0.22	280	0.90	210								
ELJNAR27KF	0.27	250	1.0	200								
ELJNAR33KF	0.33	1.0	±10 %	13	7.96	220	1.1	190				
ELJNAR39KF	0.39					200	1.2	180				
ELJNAR47KF	0.47					180	1.4	175				
ELJNAR56KF	0.56					160	1.5	170				
ELJNAR68KF	0.68					150	1.7	155				
ELJNAR82KF	0.82					135	1.9	145				
ELJNA1R0JF	1.0					± 5 %	13	7.96	7.96	120	2.1	125
ELJNA1R2JF	1.2									110	2.3	120
ELJNA1R5JF	1.5									95	2.7	115
ELJNA1R8JF	1.8									85	3.0	110
ELJNA2R2JF	2.2									80	3.2	110
ELJNA2R7JF	2.7									70	3.6	105
ELJNA3R3JF	3.3	62	4.2	100								
ELJNA3R9JF	3.9	57	4.4	95								
ELJNA4R7JF	4.7	52	7.7	70								
ELJNA5R6JF	5.6	46	8.7	65								
ELJNA6R8JF	6.8	42	10	60								
ELJNA8R2JF	8.2	38	11	60								

*1 : Self Resonant Frequency *2 : DC Resistance

Design, Specifications are subject to change without notice. Ask factory for technical specifications before purchase and/or use. Whenever a doubt about safety arises from this product, please inform us immediately for technical consultation without fail.

2. Normal Types FC, FA, SA, FB

■ Examples : Type 2520(1008)FC

Part No.	Inductance		Q min.	L , Q Test Freq.(MHz)	SRF *1 min.(MHz)	DCR *2 max.(Ω)	DC Current max.(mA)		
	μH	Tolerance							
ELJFCR22M/KF	0.22	±20 % ±10 %		25.2	230	0.70	190		
ELJFCR27M/KF	0.27				210	0.75	180		
ELJFCR33M/KF	0.33				190	0.85	170		
ELJFCR39M/KF	0.39				175	0.95	160		
ELJFCR47M/KF	0.47				160	1.0	155		
ELJFCR56M/KF	0.56				150	1.1	150		
ELJFCR68M/KF	0.68				135	1.25	140		
ELJFCR82M/KF	0.82				125	1.4	130		
ELJFC1R0K/JF	1.0	±10 % ± 5 %	25	7.96	115	0.65	195		
ELJFC1R2K/JF	1.2				100	0.75	180		
ELJFC1R5K/JF	1.5				90	0.85	170		
ELJFC1R8K/JF	1.8				85	0.95	160		
ELJFC2R2K/JF	2.2				80	1.05	155		
ELJFC2R7K/JF	2.7				75	1.2	145		
ELJFC3R3K/JF	3.3				65	1.3	135		
ELJFC3R9K/JF	3.9				60	1.4	130		
ELJFC4R7K/JF	4.7				55	1.55	125		
ELJFC5R6K/JF	5.6				50	1.75	120		
ELJFC6R8K/JF	6.8				45	1.95	115		
ELJFC8R2K/JF	8.2				40	2.2	105		
ELJFC100K/JF	10				20	2.52	32	3.5	80
ELJFC120K/JF	12						30	3.8	75
ELJFC150K/JF	15						28	4.4	70
ELJFC180K/JF	18						25	5.0	65
ELJFC220K/JF	22						22	5.8	60
ELJFC270K/JF	27						21	6.3	115
ELJFC330K/JF	33	20	7.1	110					
ELJFC390K/JF	39	18	9.5	90					
ELJFC470K/JF	47	17	11.0	80					
ELJFC560K/JF	56	16	12.1	75					
ELJFC680K/JF	68	15	16.6	70					
ELJFC820K/JF	82	13	19.0	65					
ELJFC101K/JF	100	15	0.796	12	21.0	60			

*1 : Self Resonant Frequency *2 : DC Resistance

■ Examples : Type 3225(1210)FA

Part No.	Inductance		Q min.	L , Q Test Freq.(MHz)	SRF*1 min.(MHz)	DCR*2 max.(Ω)	DC Current max.(mA)
	μH	Tolerance					
ELJFAR22M/KF2	0.22	±20 % ±10 %	25	25.2	230	0.29	360
ELJFAR27M/KF2	0.27				210	0.32	345
ELJFAR33M/KF2	0.33				190	0.35	330
ELJFAR39M/KF2	0.39				175	0.39	305
ELJFAR47M/KF2	0.47				160	0.44	290
ELJFAR56M/KF2	0.56				150	0.49	275
ELJFAR68M/KF2	0.68				135	0.55	260
ELJFAR82M/KF2	0.82				125	0.61	245
ELJFA1R0K/JF2	1.0	±10 % ± 5 %	30	7.96	115	0.69	230
ELJFA1R2K/JF2	1.2				100	0.75	215
ELJFA1R5K/JF	1.5				90	0.75	210
ELJFA1R8K/JF	1.8				85	0.82	200
ELJFA2R2K/JF	2.2				80	0.95	190
ELJFA2R7K/JF	2.7				75	1.1	180
ELJFA3R3K/JF	3.3				65	1.2	180
ELJFA3R9K/JF	3.9				60	1.3	175
ELJFA4R7K/JF	4.7				55	1.5	165
ELJFA5R6K/JF	5.6				50	1.6	160
ELJFA6R8K/JF	6.8				45	1.8	150
ELJFA8R2K/JF	8.2				40	2.0	140
ELJFA100K/JF	10				36	2.1	140
ELJFA120K/JF	12				33	2.5	125
ELJFA150K/JF	15				30	2.8	120
ELJFA180K/JF	18		27	3.3	110		
ELJFA220K/JF	22		25	3.7	105		
ELJFA270K/JF	27		22	5.0	90		
ELJFA330K/JF	33		20	5.6	85		
ELJFA390K/JF	39		20	6.4	80		
ELJFA470K/JF	47		15	7.0	75		
ELJFA560K/JF	56		15	8.0	70		
ELJFA680K/JF	68		15	9.0	65		
ELJFA820K/JF	82		11	10	60		
ELJFA101K/JF	100		10	10	60		
ELJFA121K/JF	120		10	11	55		
ELJFA151K/JF	150		8	15	50		
ELJFA181K/JF	180		7	17	50		
ELJFA221K/JF	220		7	21	45		
				20	0.796		

*1 : Self Resonant Frequency *2 : DC Resistance

■ Examples : Type 3225(1210)SA

Part No.	Inductance			Q		SRF*1 min.(MHz)	DCR*2 max.(Ω)	DC Current max.(mA)			
	μH	Freq. (MHz)	Tolerance	min.	Freq. (MHz)						
ELJSA100KF	10	1.0	±10%	40	5.0	30	1.8	18			
ELJSA120KF	12					28	2.0	17			
ELJSA150KF	15					25	2.2	15			
ELJSA180KF	18					23	2.5	13			
ELJSA220KF	22					20	2.8	12			
ELJSA270KF	27					18	3.2	10			
ELJSA330KF	33					17	3.5	10			
ELJSA390KF	39					15	3.8	9			
ELJSA470KF	47					14	4.0	8			
ELJSA560KF	56					13	4.5	7			
ELJSA680KF	68					12	5.0	6			
ELJSA820KF	82					11	6.0	6			
ELJSA101KF	100					10	7.0	5			
ELJSA121KF	120					0.1		1.5	9	8.0	5
ELJSA151KF	150								5	9.0	5
ELJSA181KF	180	5	11	5							
ELJSA221KF	220	4	12	5							
ELJSA271KF	270	4	14	5							

*1 : Self Resonant Frequency *2 : DC Resistance

■ Examples : Type 4532(1812)FB

Part No.	Inductance			Q		SRF*1 min.(MHz)	DCR*2 max.(Ω)	DC Current max.(mA)
	μH	Freq. (MHz)	Tolerance	min.	Freq. (MHz)			
ELJFB101K/JF	100	0.1	±10 % ± 5 %	40	2.52	6.7	8.8	105
ELJFB121K/JF	120				1.5	6.1	10	100
ELJFB151K/JF	150					5.5	11	95
ELJFB181K/JF	180					5.1	13	85
ELJFB221K/JF	220				0.796	4.5	13	85
ELJFB271K/JF	270					4.1	14	80
ELJFB331K/JF	330					3.7	16	75
ELJFB391K/JF	390					3.3	19	70
ELJFB471K/JF	470					3.3	31	55
ELJFB561K/JF	560					2.7	35	50
ELJFB681K/JF	680				30	2.5	39	50
ELJFB821K/JF	820					2.4	45	45
ELJFB102K/JF	1000					2.1	53	40

*1 : Self Resonant Frequency *2 : DC Resistance

Design, Specifications are subject to change without notice. Ask factory for technical specifications before purchase and/or use. Whenever a doubt about safety arises from this product, please inform us immediately for technical consultation without fail.

3. High Power Types PE, PC, PA

■ Examples : Type 1608(0603)PE

Part No.	Inductance		Q min.	L , Q Test Freq.(MHz)	SRF *1 min.(MHz)	DCR *2 max.(Ω)	DC Current max.(mA)
	nH	Tolerance					
ELJPE2N2KF	2.2	± 10 %	8	100	6000	0.030	2.1
ELJPE2N7KF	2.7				5500	0.030	2.1
ELJPE3N3KF	3.3				5500	0.040	2.1
ELJPE3N9KF	3.9				5200	0.040	2.1
ELJPE4N7KF	4.7				4800	0.050	2.1
ELJPE5N6KF	5.6				4600	0.055	2.1
ELJPE6N8KF	6.8		9		4000	0.055	1.9
ELJPE8N2KF	8.2				3500	0.060	1.7
ELJPE10NKF	10				2800	0.065	1.4
ELJPE12NKF	12				2500	0.080	1.3
ELJPE15NKF	15				2200	0.100	0.9
ELJPE18NKF	18				2000	0.120	0.8
ELJPE22NKF	22				1800	0.150	0.7

*1 : Self Resonant Frequency *2 : DC Resistance

■ Examples : Type 2520(1008)PC

Part No.	Inductance		Q min.	L , Q Test Freq.(MHz)	SRF *1 min.(MHz)	DCR *2 max.(Ω)	DC Current max.(mA)	
	μH	Tolerance						
ELJPC1R0MF	1.0	±20 %	10	7.96	95	0.45	475	
ELJPC1R5MF	1.5				85	0.55	435	
ELJPC2R2MF	2.2				65	0.65	390	
ELJPC3R3MF	3.3				8	55	0.85	340
ELJPC4R7MF	4.7					43	1.2	285
ELJPC6R8KF	6.8				8.5	44	1.3	170
ELJPC100KF	10	±10 %	20	2.52	32	2.2	210	
ELJPC120KF	12				25	2.7	195	
ELJPC150KF	15				21	3.2	175	
ELJPC220KF	22				18	4.0	160	
ELJPC330KF	33				16	6.5	120	

*1 : Self Resonant Frequency *2 : DC Resistance

Examples : Type 3225(1210)PA

Part No.	Inductance		Q min.	L , Q Test Freq.(MHz)	SRF *1 min.(MHz)	DCR *2 max.(Ω)	DC Current max.(mA)		
	μH	Tolerance							
ELJPA1R0MF	1.0	±20 %	7	7.96	150	0.15	600		
ELJPA1R5MF	1.5				110	0.18	550		
ELJPA2R2MF	2.2				80	0.23	500		
ELJPA3R3MF	3.3				58	0.28	400		
ELJPA4R7MF	4.7				46	0.34	350		
ELJPA6R8MF	6.8				38	0.42	300		
ELJPA100KF	10	±10 %	15	2.52	23	0.50	240		
ELJPA120KF	12				21	0.60	230		
ELJPA150KF	15				18	0.74	220		
ELJPA180KF	18				17	0.90	205		
ELJPA220KF	22				15	1.15	185		
ELJPA270KF	27				13	1.45	165		
ELJPA330KF	33				12	1.65	155		
ELJPA390KF	39				11	1.90	145		
ELJPA470KF	47				9.5	2.25	135		
ELJPA560KF	56				8.5	3.30	110		
ELJPA680KF	68				7.5	3.70	105		
ELJPA820KF	82				7.0	4.20	100		
ELJPA101KF	100				20	0.796	6.5	5.00	90
ELJPA121KF	120						6.0	7.00	75
ELJPA151KF	150	5.5	8.00	70					
ELJPA181KF	180	5.0	9.50	65					
ELJPA221KF	220	4.0	11.0	60					
ELJPA271KF	270	3.5	14.5	55					
ELJPA331KF	330	3.0	16.0	50					

*1 : Self Resonant Frequency *2 : DC Resistance

4. Low DC resistance Type EA

Examples : Type 3225(1210)EA

Part No.	Inductance		Q min.	L , Q Test Freq.(MHz)	SRF *1 min.(MHz)	DCR *2 max.(Ω)	DC Current max.(mA)		
	μH	Tolerance							
ELJEA1R0MF	1.0	±20 %	7	7.96	100	0.09	500		
ELJEA1R5MF	1.5				80	0.10	390		
ELJEA2R2MF	2.2				65	0.13	350		
ELJEA3R3MF	3.3				50	0.16	270		
ELJEA4R7MF	4.7				46	0.18	240		
ELJEA6R8MF	6.8				36	0.25	200		
ELJEA100KF	10	±10 %	10	2.52	29	0.34	160		
ELJEA150KF	15				25	0.42	145		
ELJEA220KF	22				18	0.65	115		
ELJEA330KF	33				16	0.91	95		
ELJEA470KF	47				13	1.30	80		
ELJEA680KF	68				10	1.95	60		
ELJEA101KF	100				20	0.796	8.0	3.12	50
ELJEA151KF	150						7.0	4.03	45
ELJEA221KF	220						5.0	7.15	35
ELJEA331KF	330						4.0	9.23	30

*1 : Self Resonant Frequency *2 : DC Resistance

Design, Specifications are subject to change without notice. Ask factory for technical specifications before purchase and/or use. Whenever a doubt about safety arises from this product, please inform us immediately for technical consultation without fail.

■ Dimensions in mm (not to scale)

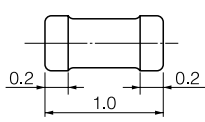

Type RF
(1.0×0.5×0.5)

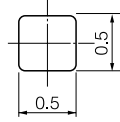

Type RE, PE
(1.6×0.8×0.8)

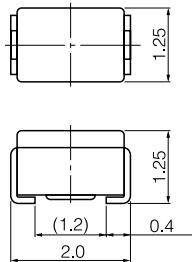
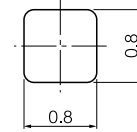
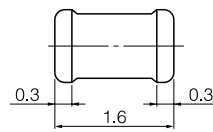

Type ND
(2.0×1.25×1.25)

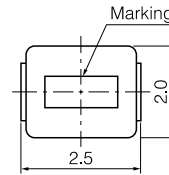
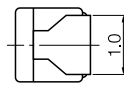

Types FC, NC, PC
(2.5×2.0×1.6)

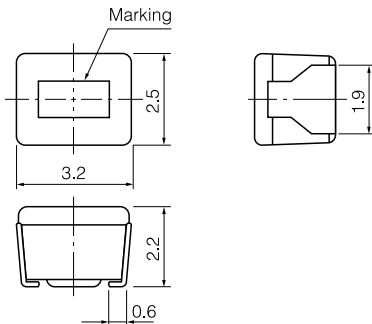
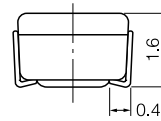
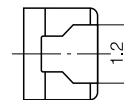

Types FA, SA, NA, PA, EA
(3.2×2.5×2.2)

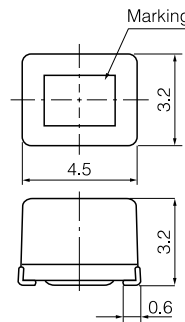

Type FB
(4.5×3.2×3.2)

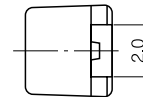

■ Recommended Land Pattern in mm (not to scale)

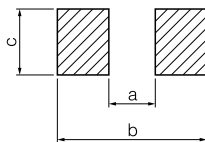

Type	a	b	c
RF	0.5~0.6	1.5~1.7	0.5~0.6
□E	0.8~1.0	2.0~2.6	0.7~0.9
ND	1.0~1.2	3.0~3.8	0.9~1.3
□C	1.4~1.5	3.5~4.0	1.2~1.6
□A	1.6~2.0	4.0~4.6	1.9~2.4
FB	2.4~2.6	5.5~6.0	2.0~3.0

□E: RE, PE □C: NC, FC, PC □A: NA, FA, SA, PA, EA

Design, Specifications are subject to change without notice. Ask factory for technical specifications before purchase and/or use. Whenever a doubt about safety arises from this product, please inform us immediately for technical consultation without fail.

■ Paper Tape Dimensions in mm (not to scale)

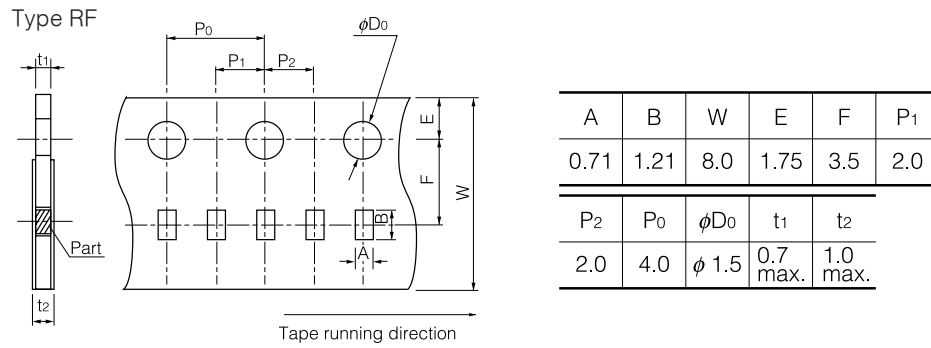

■ Embossed Carrier Tape Dimensions in mm (not to scale)

Types RE, PE, ND, NC, FC, PC (W=8 mm)

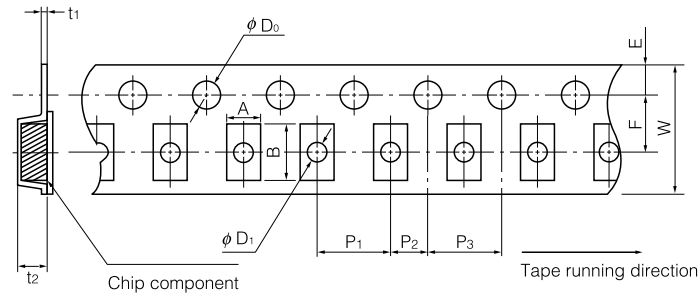

Types NA, FA, SA, PA, EA (W=8 mm)

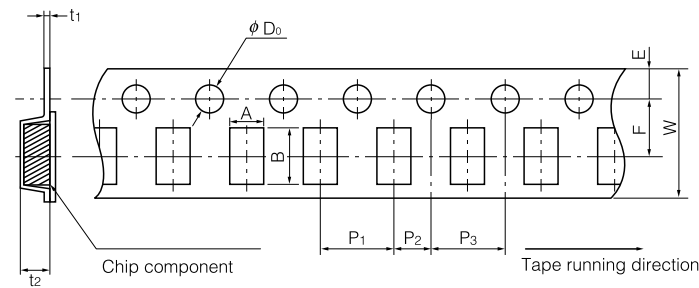

Type FB (W=12 mm)

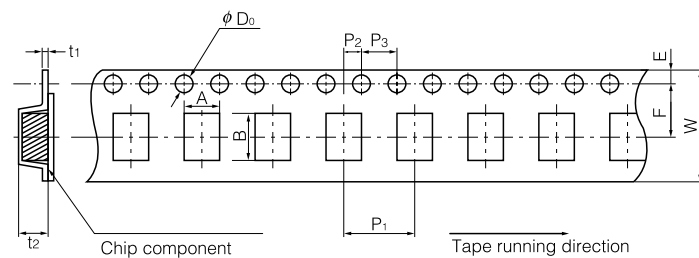

Design, Specifications are subject to change without notice. Ask factory for technical specifications before purchase and/or use. Whenever a doubt about safety arises from this product, please inform us immediately for technical consultation without fail.

Size/Types		Dimensions											
		A	B	W	F	E	P ₁	P ₂	P ₃	φD ₀	φD ₁	t ₁	t ₂
1608(0603)	RE, PE	1.0	1.8	8	3.5	1.75	4.0	2.0	4.0	1.5	0.6	(0.27)	1.2
2012(0805)	ND	1.45	2.25	8	3.5	1.75	4.0	2.0	4.0	1.5	1.0	(0.25)	1.55
2520(1008)	NC, FC, PC	2.4	2.9	8	3.5	1.75	4.0	2.0	4.0	1.5	1.1	(0.25)	1.85
3225(1210)	NA, FA, SA, PA, EA	2.8	3.6	8	3.5	1.75	4.0	2.0	4.0	1.5	—	(0.25)	2.4
4532(1812)	FB	3.6	4.9	12	5.5	1.75	8.0	2.0	4.0	1.5	—	(0.3)	3.5

■ Packaging Methods

● Standard Packing Quantity and Mass

Types	Quantity, Mass	
	Quantity	Mass (Weight) Approx.
RF	10000 pcs.	—
RE, PE, ND	3000 pcs.	90 g
NC, FC, PC	2000 pcs.	100 g
NA, FA, SA, PA, EA	2000 pcs.	170 g
FB	500 pcs.	100 g

■ Reel Dimensions in mm (not to scale)

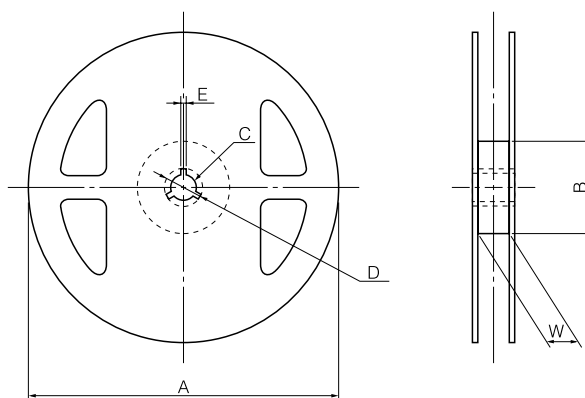

Types	Dimensions					
	A	B	C	D	E	W
RF	180	60	13	21	2	9
RE, PE, ND, NC, FC PC, NA, FA, SA, PA, EA	180	60	13	21	2	9
FB	180	60	13	21	2	13

Design, Specifications are subject to change without notice. Ask factory for technical specifications before purchase and/or use. Whenever a doubt about safety arises from this product, please inform us immediately for technical consultation without fail.

Cautions for use

For securing upgraded reliability and safety, consider following caution items.

1. Land pattern design

Refer to the recommended land dimensions of each type at flow and reflow solderings.

Avoid placing the chip inductor on any metal pattern except the land because the drop of Q and mutual conductance may occur.

Provisions for venting of flux gases should be made for high density assemblies.

2. Mounting

Placement force should not exceed 20N because electric and magnetic characteristics change by applying strong force.

3. Soldering

Ⓐ Flow soldering

Recommended conditions; 260 °C max., 5sec. max.(total time at 2 waves method)

Ⓑ Reflow soldering

① Infra-red reflow soldering

Recommended conditions: 200 °C or high at electrode, 60sec. max. and peak 250 °C max., 5sec. max.

If the solder at the two electrodes are not melt simultaneously, the chip inductor may not be mounted on the right place.

It is recommended to fix by adhesive when the deviation is great.

② VPS reflow soldering

Recommended conditions: 215±5 °C, 20 to 60sec.

4. Cleaning

① Do not use acid or alkali agents. Some cleaning solvents out of CFC may damage the products. Confirm the reliability in advance.

② If ultrasonic cleaning is employed, please inform us immediately for technical consultation.

5. Instructions for applying current

The rated current is defined as the smaller value of either the current value when the inductance drops 10 % down from the initial point, or the current value when the average temperature of coil inside rises 20 K up from initial point.

Do not operate this coils beyond the specified rated current.

6. Storage

① Be careful a high temperature, a large amount of moisture, gases and magnetic field.

② At long storage of more than 1 year, use the products after inspecting the outer structure