

Classification	REFERENCE SPECIFICATION	Issue No. 20090914
Part Name LIGHT TOUCH SWITCH	Part No. EVQP4M03K	1/8
<p>1. Notification Items</p> <p>1.1 Law and the regulation which are applied</p> <p>①This product has not been manufactured with ozone depleting chemical controlled under the Montreal Protocol.</p> <p>②This product complies with the RoHS Directive (Restriction of the use of certain Hazardous Substance) in electrical and electronic equipment (DIRECTIVE 2002/95/EC).</p> <p>③All the materials used in this part are registered material under the Law Concerning the Examination and Regulation of Manufacture etc. or Chemical Substances.</p> <p>④Permission must be obtained from the Japanese government if the product that is subject to the "Foreign Exchange and Foreign Trade Law" is to be exported or taken out of Japan.</p> <p>1.2 Application Limits</p> <p>This product was designed and manufactured for general electronics devices household appliances, office equipment, data and communication equipment.</p> <p>For the following applications in which high reliability and safety are required, or for the applications in which the failure or malfunction of the products may directly jeopardize life or cause threat of personal asset, please contact us beforehand.</p> <ul style="list-style-type: none"> •Aircraft and aerospace equipment, anti-disaster or anti-crime equipment, medical equipment, transport equipment(automotives, trains, boat etc), high public information processing devices or the other equipments or devices that are equivalent to the above mentioned. <p>1.3 Handling of reference specification.</p> <ul style="list-style-type: none"> • Since the contents of this reference specification are subjected to change without prior notifications, please request us a formal specification again for your investigations before using. <p>1.4 Manufacturing Sites</p> <p>① The country of manufacture : Japan Panasonic Electronic Devices Japan Co., Ltd.</p> <p>2. Summary</p> <p>2.1 This specifications applies to the following types of switch. Push-ON type S.P.S.T</p> <p>2.2 This specifications is a constituent document of contract for business concluded between your company and Panasonic Corporation.</p> <p>2.3 Items not particularly specified in this specifications shall be in conformance with JIS Standards.</p>		

Panasonic Electronic Devices Co., Ltd.

Classification	REFERENCE SPECIFICATION	Issue No. 20090914
Part Name LIGHT TOUCH SWITCH	Part No. EVQP4M03K	2/8

3. Dimension • Marking • Circuit diagram

Date code are indicated in the product.

General dimension tolerance: ± 0.2
 () dimensions are reference dimensions.

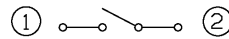
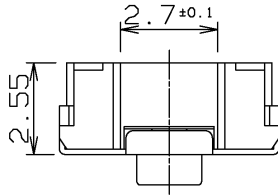

Circuit Diagram

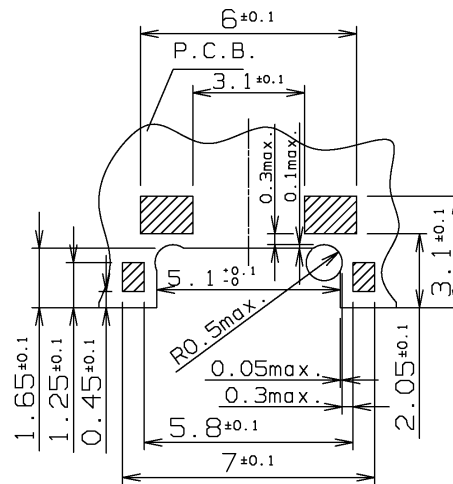
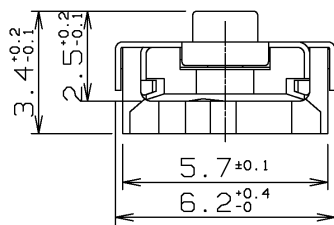
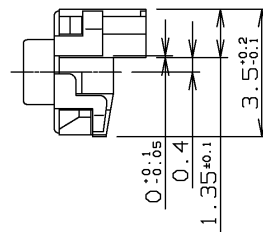
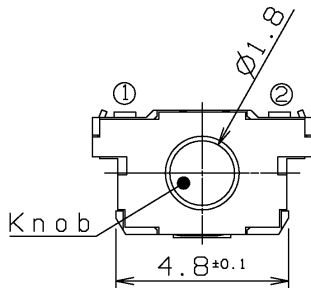

Knob color : BLACK

Piece weight : 0.075g

Solder thickness $t=0.15\pm 0.03$

Land pattern plan

Note: Please put your consideration not to let any burrs of printed wiring board stick out from the mounting surface of our switches.

Classification	REFERENCE SPECIFICATION	Issue No. 20090914
Part Name LIGHT TOUCH SWITCH	Part No. EVQP4M03K	3/8

4. General specification

4.1 Switch rating DC 15 V 20 mA(max.) DC 2V 10 μ A(min.)

4.2 Operation temperature range -40 $^{\circ}$ C ~ +85 $^{\circ}$ C

4.3 Preservative temperature range
 Single condition : -40~+85 $^{\circ}$ C
 Taping condition : -20~+60 $^{\circ}$ C

4.4 Standard conditions

Unless otherwise specified, the test and measurements shall be carried out as follows.

Ambient temperature : 5~35 $^{\circ}$ C

Relative humidity : 45~85 %

Air pressure : 86~106 kPa

However, if doubt arises on the decision based on the measured values under the above-mentioned conditions, the following conditions shall be employed.

Ambient temperature : 20 \pm 2 $^{\circ}$ C

Relative humidity : 65 \pm 5 %

Air pressure : 86~106 kPa

5. Performance

5.1 Electrical characteristics

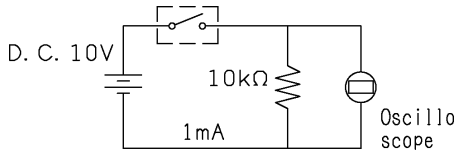
No.	ITEM	TEST CONDITION	PERFORMANCE
5.1.1	Contact resistance	Push force : {Operation force} \times 2 Measurement tool : Contact resistance meter (Capable of 10 μ A ~ 10 mA)	100 m Ω max.
5.1.2	Insulation resistance	DC 100 V (Between terminals)	100 M Ω min.
5.1.3	Withstand voltage	AC 250 V for 1 minute. (Between terminals)	No insulation destruction
5.1.4	Bouncing	Operation speed : 3~4 times/s  Switch Bouncing Test Circuit	ON 10 ms max. OFF 10 ms max.

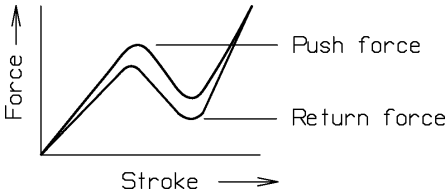
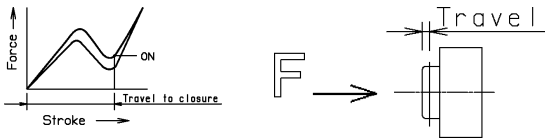
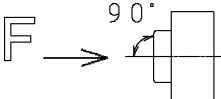
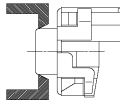
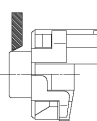
Classification		REFERENCE SPECIFICATION		Issue No.
Part Name LIGHT TOUCH SWITCH		Part No. EVQP4M03K		20090914
				4/8
5.2 Mechanical characteristics				
No.	ITEM	TEST CONDITION		PERFORMANCE
5.2.1	Operation force			Push force $5.0^{+1.0}_{-1.0}$ N Return force 0.1 N min.
5.2.2	Travel to closure			$0.70^{+0.20}_{-0.20}$ mm
5.2.3	Push strength	50 N for 60 sec. 		No damage (Electrical and mechanical)
5.2.4	Pull strength	Vertical direction  Horizontal direction 		Vertical direction : 0.5N min. Horizontal direction : 0.5N min.
5.2.5	Vibration test	1) Amplitude : 1.5 mm 2) Sweep rate : 10-55-10Hz for 1 minute 3) Sweep method : Logarithmic frequency sweep rate 4) Vibration direction : X,Y,Z(3 directions) 5) Time : Each direction 2 hours (Total 6 hours)		No. 5.1 and 5.2.1 to 5.2.2 shall be satisfied.
5.2.6	Soldering heat test	Mount the switch on P.W.B by adhesive. 1) Reflow process 2 times. (Refer to section 6.1) 2) Standard conditions after test : 1 hours		Contact resistance 100 mΩ max. No. 5.1.2 to 5.1.4 and No. 5.2.1 to 5.2.2 shall be satisfied.
5.2.7	Solderability	After spreading flux, the terminal is immersed in solder with following condition. Solder ber : M705/Sn-3.0Ag-0.5Cu (Senju Metal Indusy Co.,Ltd.) Flux : CF-110VH-2A (tamura kaken) Soldering temperture : $260 \pm 5^{\circ}\text{C}$ Soldering time : 2 ± 0.5 sec.		95% or more of surface area(Excluding ruptured surface)where is immersed in solder shall be covered by new solder.

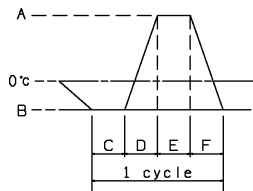
Classification		REFERENCE SPECIFICATION		Issue No.
Part Name LIGHT TOUCH SWITCH		Part No. EVQP4M03K		20090914
				5/8
5.3 Climatic characteristics				
No.	ITEM	TEST CONDITION	PERFORMANCE	
5.3.1	Cold test	1) Temperature : -40 ± 2 °C 2) Duration of test : 500 h 3) Take off a drop water. 4) Standard conditions after test : 1 h	Contact resistance 200 mΩ max. No. 5.1.2 to 5.1.4 and No. 5.2.1 to 5.2.2 shall be satisfied.	
5.3.2	Heat test	1) Temperature : 85 ± 2 °C 2) Duration of test : 500 h 3) Standard conditions after test : 1 h	Contact resistance 200 mΩ max. No. 5.1.2 to 5.1.4 and No. 5.2.1 to 5.2.2 shall be satisfied.	
5.3.3	Heat shock test	1) Test cycles : 20 cycles 2) Standard conditions after test : 1 h  A: $+85\pm 2$ °C B: -40 ± 2 °C C: 1 hour D: 5 minutes max. E: 1 hour F: 5 minutes max.	Contact resistance 200 mΩ max. No. 5.1.2 to 5.1.4 and No. 5.2.1 to 5.2.2 shall be satisfied.	
5.3.4	Humidity test	1) Temperature : 60 ± 2 °C 2) Relative humidity : 90~95 % 3) Duration of test : 500 h 4) Take off a drop water. 5) Standard conditions after test : 1 h	Contact resistance 200 mΩ max. No. 5.1.2 to 5.1.4 and No. 5.2.1 to 5.2.2 shall be satisfied.	
5.3.5	Endurance (Switching action)	1) DC 15 V 20 mA Resistance load 2) Operation speed : 2~3 times/s 3) Push force : Maximum value of operation force 4) Operation number : 200,000 times	Contact resistance 20 Ω max. Bouncing : 10 ms max. Variation rate of operation force shall be within ± 30 % to the value before testing No. 5.1.2 and 5.2.2 shall be satisfied.	
5.3.6	Withstand H ₂ S	1) Density : 3 ± 1 ppm 2) Temperature : 40 ± 2 °C 3) Relative humidity : 80~85 % 4) Duration of test : 24 h 5) Standard conditions after test : 1 h	Contact resistance 200 mΩ max. No. 5.1.2 to 5.1.4 and No. 5.2.1 to 5.2.2 shall be satisfied.	

Classification	REFERENCE SPECIFICATION	Issue No. 20090914
Part Name LIGHT TOUCH SWITCH	Part No. EVQP4M03K	6/8

6. Prohibitions and precaution for handling

6.1 Reflow soldering condition

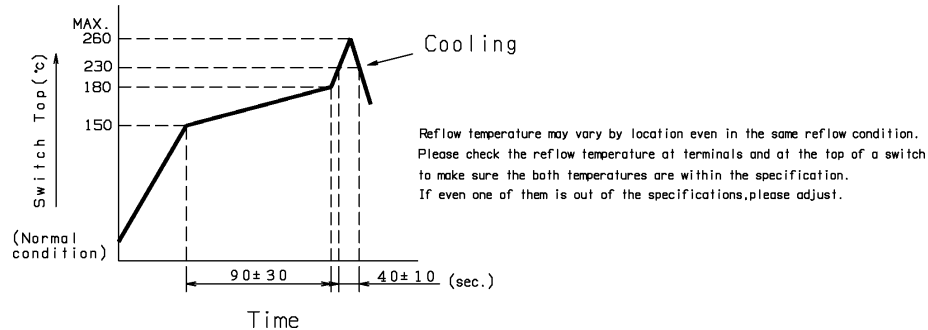

- 1) Two times max. with directing the switch mounting side of P.W.B up.
- 2) Re-soldering by soldering iron shall be allowed under 350°C max. 3 sec. max. 1 time only and the tip of iron must not touch to terminals.
Soldering iron for re-soldering have to be 60W max.

6.2 Design instructions

- 1) Please refer to the land pattern plan Panasonic recommends on the 2nd page.
- 2) Design key top as fig-1. Design inclination of key top 4 deg. max. as fig-2.
Tolerance between switch and key top is within 0.3mm .as fig-3.
(Recommended operation condition)

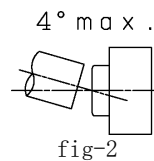
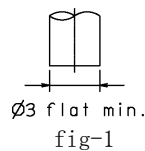

6.3 Notes

- 1) Please be cautions not to give excessive static load or shock to switches.
- 2) Please be careful not to pile up P.W.B. after switches were soldered.
- 3) Preservation under high temperature and high humidity or corrosive gas should be avoided especially. When you need to preserve for a long period, do not open the carton.
- 4) Avoid pressing the film portion of the product with sharp-edged object.
- 5) Cleaning
 - If flux or solder is scattered on the surface of P.W.B when soldering, characteristics of this product may be damaged.
 - Cleaning after soldering is not allowed. When cleaning is required this switch should be soldered after the cleaning.
- 6) Avoid the use of the switch under pushed ON condition is continued for a long time.
- 7) There is a possibility the flux from solder paste infiltrates into the body if plenty of solder paste was applied by switch on the P.W.B.
So we recommend to use our proposed land design in order to prevent above problem.
Also please avoid putting additional land by the switch on the P.W.B.

Classification	REFERENCE SPECIFICATION	Issue No. 20090914
Part Name LIGHT TOUCH SWITCH	Part No. EVQP4M03K	7/8

7. Packing specification

Carrier tape

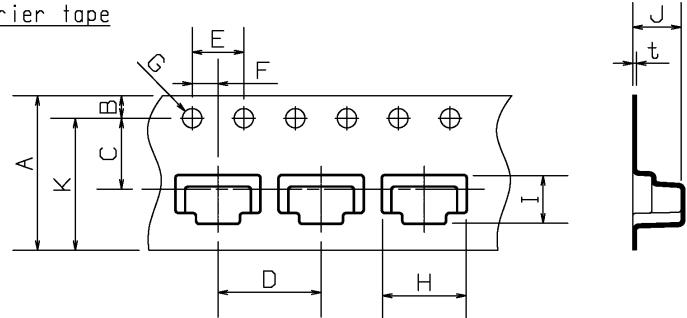

Take out direction → Unit:mm

A	B	C	D	E	F	G	H	I	J	t	K
±0.3	±0.1	±0.1	±0.1	±0.1	±0.1	±0.1	±0.2	±0.2	±0.2	±0.1	(10.25)
12	1.75	5.5	8	4	2	1.5	6.5	3.9	3.75	0.4	

Taping condition : Lack of products in the middle of taping should be one MAX, but total quantity specified in the specifications should be secured.

Peeling off strength of top tape : It should be within 0.2N to 1.0N at 165 degree in peeling off angle.

Joint of carrier tape : One joint per one reel may exist.

Reel (2500pcs./reel)

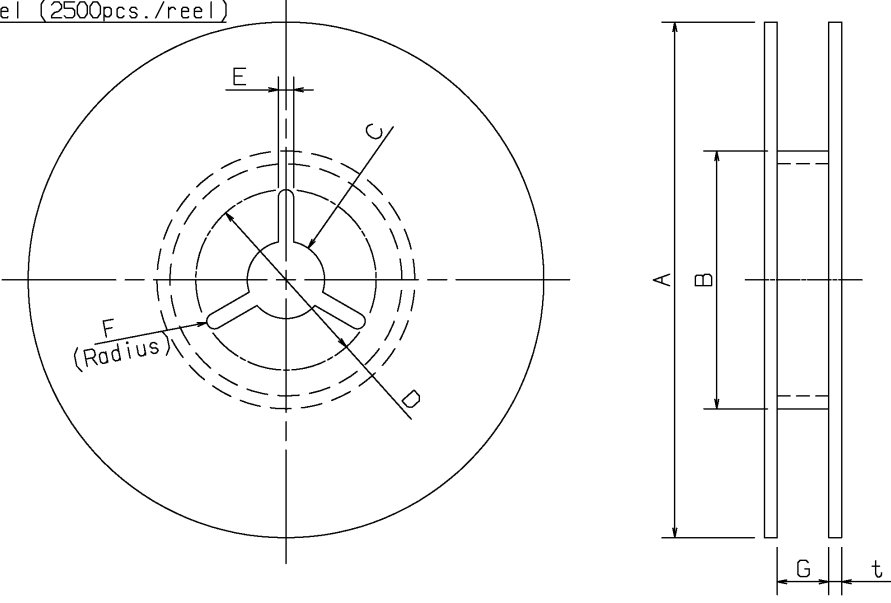

Unit:mm

A	B	C	D	E	F	G	t
±2		±0.5	±1	±0.5	±0.5	±1.5	
∅370	∅50min	∅13	∅21	2	1	14	1~3

Classification	REFERENCE SPECIFICATION	Issue No. 20090914
Part Name LIGHT TOUCH SWITCH	Part No. EVQP4M03K	8/8
<p><Prohibitions and precaution for handling></p> <p>【Prohibited items on fire and smoking】</p> <ul style="list-style-type: none"> • Absolutely avoid use of a product beyond its rated range because doing so may cause a fire. If misuse or abnormal use may result under conditions in which the product is used out of its rated range, take proper measures such as current interruption using a protective circuit. • The grade of nonflammability for resin used in product is "94HB," which is based on UL94 Standards (flammability test for plastic materials). Prohibit use in a location where a spreading fire may be generated or prepare against a spreading fire. <p>【For use in equipment for which safety is requested】</p> <ul style="list-style-type: none"> • Although care is taken to ensure product quality, inferior characteristics, short circuits, and open circuits are some problems that might be generated, To design an equipment which places maximum emphasis on safety, review the effect of any single fault of a product in advance and perform virtually fail-safe design to ensure maximum safety by: <ul style="list-style-type: none"> • Preparing a protective circuit or a protective device to improve system safety, and equipment. • Preparing a redundant circuit to improve system safety so that the single fault of a product does not cause a dangerous situation. <p>【Attentions required for storage condition】</p> <ul style="list-style-type: none"> • When this product is to be stored in the following circumstances and conditions, it may affect on the performance deteriorations and solderability etc., avoid storing in the following conditions. <ol style="list-style-type: none"> (1) A place where the temperature is -10°C max., +40°C min. and the humidity is 85% min. (2) In the corrosive gas atmosphere. (3) Long-term storage for 6 months min. (4) A place where the product is exposed to direct sunlight. • Store in packed condition so that the load stress is not applied. • Please use this product as soon as possible, our recommendation is within 3 months and the limitation is 6 months. • If any remainder left after packing is opened, store it with proper moistureproofing and gasproofing, etc., 		

6.2mmx2.5mm Side-operational Edge Mount Light Touch Switches

--- Edge Mounting Condition ---

NO.	ITEM	CONDITION	Fig.
①	Nozzle Type	$\phi 1.6 \sim \phi 2$ mm	Fig.3
②	Recognition Position of Switch	Dimension of Mounting base	Fig.4
③	Mounting(Insert) Position	Switch to P.W.B. Edge 0.1~0.15mm	Fig.5
④	Tact time	0.2 s/shot min.	
⑤	Nozzle Stroke	1.4 ± 0.35 mm	Fig.6
⑥	Line sensor	OFF	
⑦	Soldering	Self alignment effect. Switch to P.W.B. Edge 0.2mm max.	Fig.7

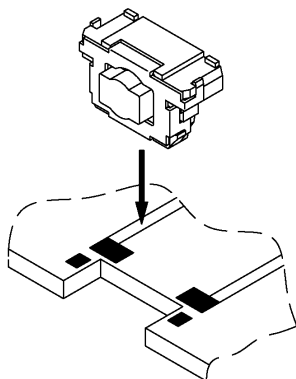

Fig.1 Edge Mounting

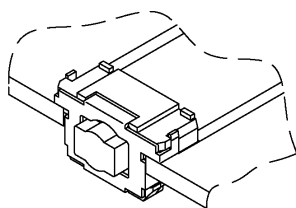

Fig.2 Soldering

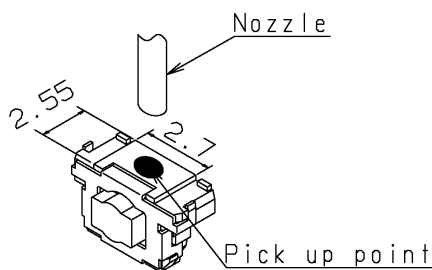

Fig.3 Pick up

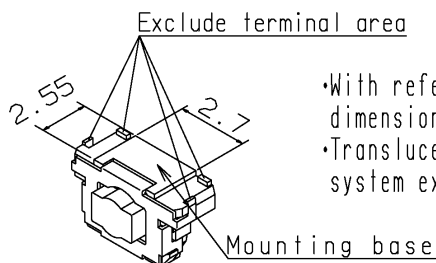

Fig.4 Recognition position of Switch

- With reference to the outer dimensions of mounting base.
- Translucent system and reflect system exclude the terminal area.

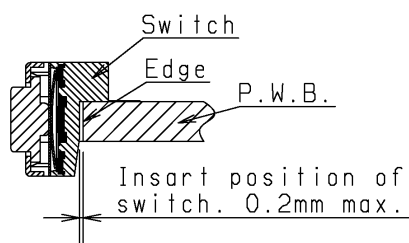

Fig.5. Mounting(Insert) Position

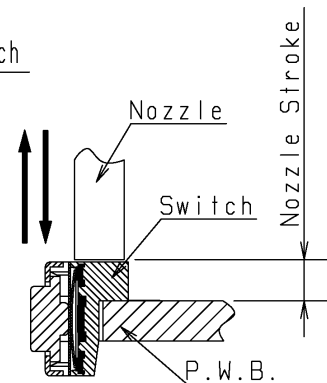

Fig.6 Nozzle stroke

Mounting

After Soldering

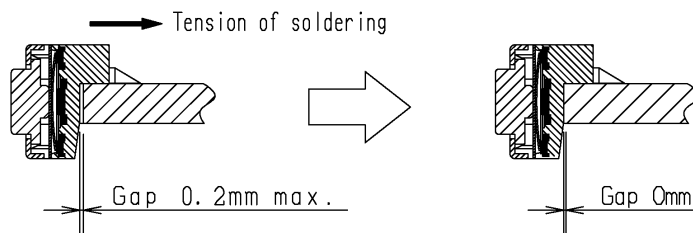

Fig.7 Soldering(Self alignment effect)

The nozzle needs to be set for the shape and the position that would not effect the recognition.