

## LOGIC-INPUT CMOS QUAD DRIVERS

### FEATURES

- High Peak Output Current ..... 1.2A
- Wide Operating Range ..... 4.5 to 18V
- Symmetrical Rise and Fall Times ..... 25nsec
- Short, Equal Delay Times ..... 75nsec
- Latchproof! Withstands 500mA Inductive Kickback
- 3 Input Logic Choices
  - AND / NAND / AND + Inv
- 2kV ESD Protection on All Pins

### APPLICATIONS

- General-Purpose CMOS Logic Buffer
- Driving All Four MOSFETs in an H-Bridge
- Direct Small Motor Driver
- Relay or Peripheral Drivers
- CCD Driver
- Pin-Switching Network Driver

### GENERAL DESCRIPTION

The TC446X family of four-output CMOS buffer/drivers are an expansion from our earlier single- and dual-output drivers. Each driver has been equipped with a two-input logic gate for added flexibility.

The TC446X drivers can source up to 250 mA into loads referenced to ground. Heavily loaded clock lines, coaxial cables, and piezoelectric transducers can all be easily driven with the 446X series drivers. The only limitation on loading is that total power dissipation in the IC must be kept within the power dissipation limits of the package.

The TC446X series will not latch under any conditions within their power and voltage ratings. They are not subject to damage when up to 5V of noise spiking (either polarity) occurs on the ground line. They can accept up to half an amp of inductive kickback current (either polarity) into their outputs without damage or logic upset. In addition, all terminals are protected against ESD to at least 2000V.

**4**

### ORDERING INFORMATION

Part No.	Package	Temp. Range
TC446xCOE	16-Pin SOIC (Wide)	0° to +70°C
TC446xCPD	14-Pin Plastic DIP	0° to +70°C
TC446xEJD	14-Pin CerDIP	- 40° to +85°C
TC446xMJD	14-Pin CerDIP	- 55° to +125°C

x indicates a digit must be added in this position to define the device input configuration: TC446x — 7 NAND  
8 AND  
9 AND with INV

### LOGIC DIAGRAMS

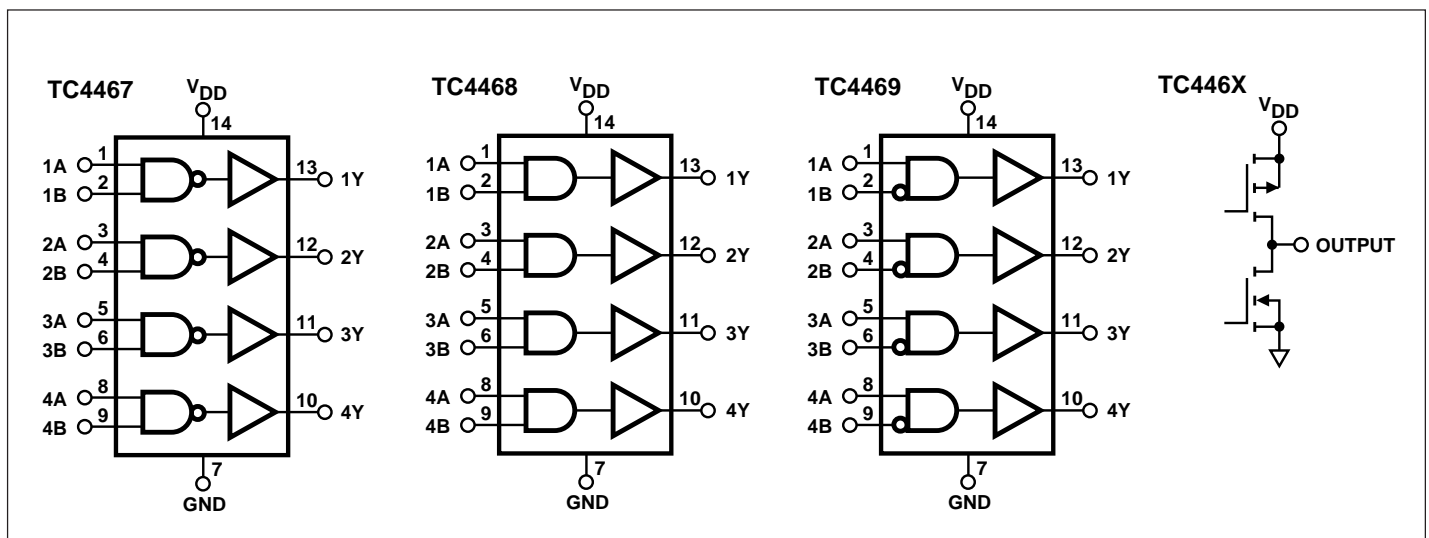

**TC4467  
TC4468  
TC4469**

**ABSOLUTE MAXIMUM RATINGS\***

Supply Voltage .....	+20V
Input Voltage .....	(GND – 5V) to (V <sub>DD</sub> + 0.3V)
Maximum Chip Temperature	
Operating .....	+150°C
Storage .....	– 65° to +150°C
Maximum Lead Temperature	
(Soldering, 10 sec) .....	+300°C
Operating Ambient Temperature Range	
C Device .....	0° to +70°C
E Device .....	– 40° to +85°C
M Device .....	– 55° to +125°C
Package Power Dissipation (T <sub>A</sub> ≤ 70°C)	
14-Pin CerDIP .....	840mW
14-Pin Plastic DIP .....	800mW
16-Pin Wide SOIC .....	760mW

Package Thermal Resistance

14-Pin CerDIP	R <sub>θJ-A</sub> .....	100°C/W
	R <sub>θJ-C</sub> .....	23°C/W
14-Pin Plastic DIP	R <sub>θJ-A</sub> .....	80°C/W
	R <sub>θJ-C</sub> .....	35°C/W
16-Pin Wide SOIC	R <sub>θJ-A</sub> .....	95°C/W
	R <sub>θJ-C</sub> .....	28°C/W

\*Static-sensitive device. Unused devices must be stored in conductive material. Protect devices from static discharge and static fields. Stresses above those listed under Absolute Maximum Ratings may cause permanent damage to the device. These are stress ratings only and functional operation of the device at these or any other conditions above those indicated in the operational sections of the specifications is not implied. Exposure to Absolute Maximum Rating Conditions for extended periods may affect device reliability.

**ELECTRICAL CHARACTERISTICS:** Measured at T<sub>A</sub> = +25°C with 4.5V ≤ V<sub>DD</sub> ≤ 18V, unless otherwise specified.

Symbol	Parameter	Test Conditions	Min	Typ	Max	Unit
<b>Input</b>						
V <sub>IH</sub>	Logic 1, High Input Voltage	Note 3	2.4	—	V <sub>DD</sub>	V
V <sub>IL</sub>	Logic 0, Low Input Voltage	Note 3	0	—	0.8	V
I <sub>IN</sub>	Input Current	0V ≤ V <sub>IN</sub> ≤ V <sub>DD</sub>	– 1	—	1	μA
<b>Output</b>						
V <sub>OH</sub>	High Output Voltage	I <sub>LOAD</sub> = 100μA (Note 1)	V <sub>DD</sub> – 0.025	—	—	V
V <sub>OL</sub>	Low Output Voltage	I <sub>LOAD</sub> = 10mA (Note 1)	—	—	0.15	V
R <sub>O</sub>	Output Resistance	I <sub>OUT</sub> = 10mA, V <sub>DD</sub> = 18V	—	10	15	Ω
I <sub>PK</sub>	Peak Output Current		—	1.2	—	A
I <sub>DC</sub>	Continuous Output Current	Single Output Total Package	—	—	300 500	mA
I	Latch-Up Protection Withstand Reverse Current	4.5V ≤ V <sub>DD</sub> ≤ 16V	500	—	—	mA
<b>Switching Time</b>						
t <sub>R</sub>	Rise Time	Figure 1	—	15	25	nsec
t <sub>F</sub>	Fall Time	Figure 1	—	15	25	nsec
t <sub>D1</sub>	Delay Time	Figure 1	—	40	75	nsec
t <sub>D2</sub>	Delay Time	Figure 1	—	40	75	nsec
<b>Power Supply</b>						
I <sub>S</sub>	Power Supply Current		—	1.5	4	mA
V <sub>DD</sub>	Power Supply Voltage	Note 2	4.5	—	18	V

**TRUTH TABLE**

Part No.	TC4467 NAND				TC4468 AND				TC4469 AND/INV			
<b>INPUTS A</b>	H	H	L	L	H	H	L	L	H	H	L	L
<b>INPUTS B</b>	H	L	H	L	H	L	H	L	H	L	H	L
<b>OUTPUTS TC446X</b>	L	H	H	H	H	L	L	L	L	H	L	L

H = High L = Low

# LOGIC-INPUT CMOS QUAD DRIVERS

**TC4467**  
**TC4468**  
**TC4469**

**ELECTRICAL CHARACTERISTICS:** Measured throughout operating temperature range with  $4.5V \leq V_{DD} \leq 18V$ , unless otherwise specified.

Symbol	Parameter	Test Conditions	Min	Typ	Max	Unit
<b>Input</b>						
$V_{IH}$	Logic 1, High Input Voltage	(Note 3)	2.4	—	—	V
$V_{IL}$	Logic 0, Low Input Voltage	(Note 3)	—	—	0.8	V
$I_{IN}$	Input Current	$0V \leq V_{IN} \leq V_{DD}$	-10	—	10	$\mu A$
<b>Output</b>						
$V_{OH}$	High Output Voltage	$I_{LOAD} = 100 \mu A$ (Note 1)	$V_{DD} - 0.025$	—	—	V
$V_{OL}$	Low Output Voltage	$I_{LOAD} = 10 mA$ (Note 1)	—	—	0.30	V
$R_O$	Output Resistance	$I_{OUT} = 10 mA, V_{DD} = 18V$	—	20	30	$\Omega$
$I_{PK}$	Peak Output Current		—	1.2	—	A
$I$	Latch-Up Protection Withstand Reverse Current	$4.5V \leq V_{DD} \leq 16V$	500	—	—	mA
<b>Switching Time</b>						
$t_R$	Rise Time	Figure 1	—	—	50	nsec
$t_F$	Fall Time	Figure 1	—	—	50	nsec
$t_{D1}$	Delay Time	Figure 1	—	—	100	nsec
$t_{D2}$	Delay Time	Figure 1	—	—	100	nsec
<b>Power Supply</b>						
$I_S$	Power Supply Current		—	—	8	mA
$I_S$	Power Supply Voltage	Note 2	4.5	—	18	V

- NOTES:**
1. Totem-pole outputs should not be paralleled because the propagation delay differences from one to the other could cause one driver to drive high a few nanoseconds before another. The resulting current spike, although short, may decrease the life of the device.
  2. When driving all four outputs simultaneously in the same direction,  $V_{DD}$  shall be limited to 16V. This reduces the chance that internal  $dv/dt$  will cause high-power dissipation in the device.
  3. The input threshold has about 50 mV of hysteresis centered at approximately 1.5V. Slow moving inputs will force the device to dissipate high peak currents as the input transitions through this band. Input rise times should be kept below 5  $\mu s$  to avoid high internal peak currents during input transitions. Static input levels should also be maintained above the maximum or below the minimum input levels specified in the "Electrical Characteristics" to avoid increased power dissipation in the device.

## PIN CONFIGURATIONS

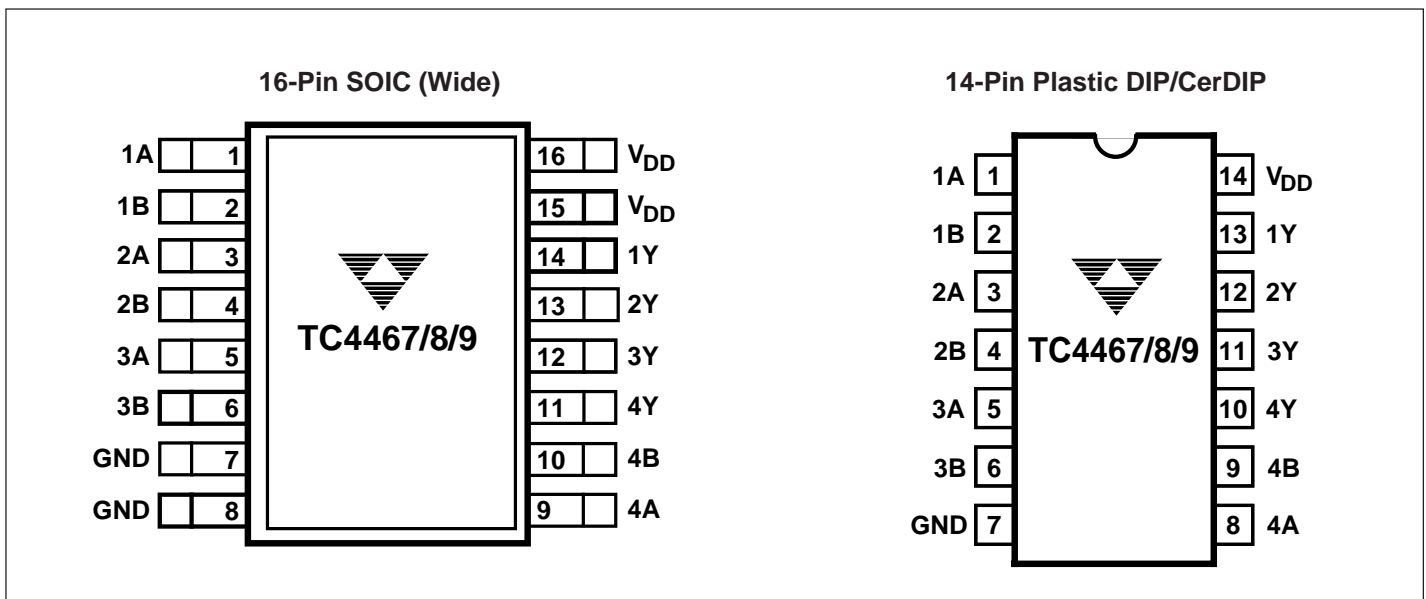

## TC4467 TC4468 TC4469

### Supply Bypassing

Large currents are required to charge and discharge large capacitive loads quickly. For example, charging a 1000 pF load to 18V in 25nsec requires 0.72A from the device's power supply.

To guarantee low supply impedance over a wide frequency range, a 1  $\mu$ F film capacitor in parallel with one or two low-inductance 0.1  $\mu$ F ceramic disk capacitors with short lead lengths (<0.5 in.) normally provide adequate bypassing.

### Grounding

The TC4467 and TC4469 contain inverting drivers. Potential drops developed in common ground impedances from input to output will appear as negative feedback and degrade switching speed characteristics. Instead, individual ground returns for input and output circuits, or a ground plane, should be used.

### Input Stage

The input voltage level changes the no-load or quiescent supply current. The N-channel MOSFET input stage transistor drives a 2.5 mA current source load. With logic "0" outputs, maximum quiescent supply current is 4 mA. Logic "1" output level signals reduce quiescent current to 1.4 mA maximum. Unused driver inputs must be connected to  $V_{DD}$  or  $V_{SS}$ . Minimum power dissipation occurs for logic "1" outputs.

The drivers are designed with 50 mV of hysteresis. This provides clean transitions and minimizes output stage current spiking when changing states. Input voltage thresholds are approximately 1.5V, making any voltage greater than 1.5V up to  $V_{DD}$  a logic 1 input. Input current is less than 1  $\mu$ A over this range.

### Power Dissipation

The supply current versus frequency and supply current versus capacitive load characteristic curves will aid in determining power dissipation calculations. TelCom Semiconductor's CMOS drivers have greatly reduced quiescent DC power consumption.

Input signal duty cycle, power supply voltage and load type, influence package power dissipation. Given power dissipation and package thermal resistance, the maximum ambient operating temperature is easily calculated. The 14-pin plastic package junction-to-ambient thermal resistance is 83.3°C/W. At +70°C, the package is rated at 800mW maximum dissipation. Maximum allowable chip temperature is +150°C.

Three components make up total package power dissipation:

- (1) Load-caused dissipation ( $P_L$ )
- (2) Quiescent power ( $P_Q$ )
- (3) Transition power ( $P_T$ ).

A capacitive-load-caused dissipation (driving MOSFET gates), is a direct function of frequency, capacitive load, and supply voltage. The power dissipation is:

$$P_L = f C V_S^2,$$

where:  $f$  = Switching frequency  
 $C$  = Capacitive load  
 $V_S$  = Supply voltage.

A resistive-load-caused dissipation for ground-referenced loads is a function of duty cycle, load current, and load voltage. The power dissipation is:

$$P_L = D (V_S - V_L) I_L,$$

where:  $D$  = Duty cycle  
 $V_S$  = Supply voltage  
 $V_L$  = Load voltage  
 $I_L$  = Load current.

A resistive-load-caused dissipation for supply-referenced loads is a function of duty cycle, load current, and output voltage. The power dissipation is:

$$P_L = D V_O I_L,$$

where:  $f$  = Switching frequency  
 $V_O$  = Device output voltage  
 $I_L$  = Load current.

Quiescent power dissipation depends on input signal duty cycle. Logic HIGH outputs result in a lower power dissipation mode, with only 0.6 mA total current drain (all devices driven). Logic LOW outputs raise the current to 4 mA maximum. The quiescent power dissipation is:

$$P_Q = V_S (D (I_H) + (1-D)I_L),$$

where:  $I_H$  = Quiescent current with all outputs LOW (4 mA max)  
 $I_L$  = Quiescent current with all outputs HIGH (0.6 mA max)  
 $D$  = Duty cycle  
 $V_S$  = Supply voltage.

Transition power dissipation arises in the complementary configuration (TC446X) because the output stage N-channel and P-channel MOS transistors are ON simultaneously for a very short period when the output changes. The transition power dissipation is approximately:

$$P_T = f V_S (10 \times 10^{-9}).$$

Package power dissipation is the sum of load, quiescent and transition power dissipations. An example shows the relative magnitude for each term:

- C = 1000 pF capacitive load
- V<sub>S</sub> = 15V
- D = 50%
- f = 200 kHz
- P<sub>D</sub> = Package Power Dissipation = P<sub>L</sub> + P<sub>Q</sub> + P<sub>T</sub>  
= 45 mW + 35 mW + 30 mW = 110 mW.

Maximum operating temperature:

$$T_J - \theta_{JA} (P_D) = 141^\circ\text{C},$$

where: T<sub>J</sub> = Maximum allowable junction temperature (+150°C)

θ<sub>JA</sub> = Junction-to-ambient thermal resistance (83.3°C/W) 14-pin plastic package.

**NOTE:** Ambient operating temperature should not exceed +85°C for "EJD" device or +125°C for "MJD" device.

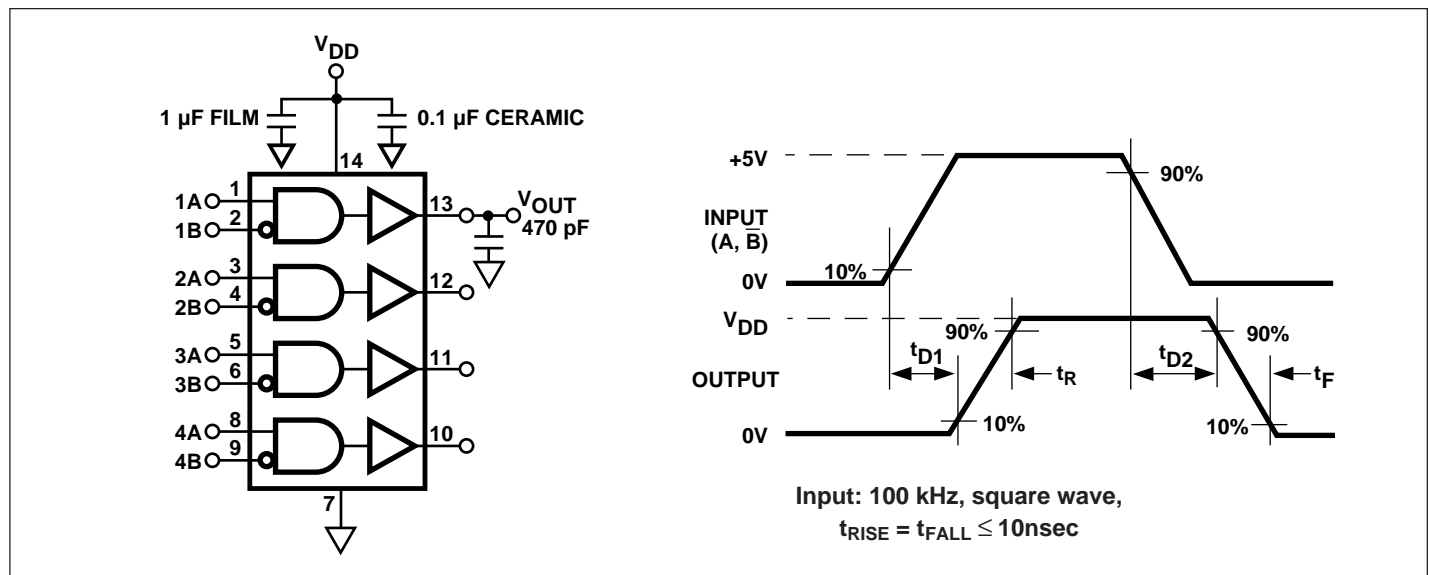
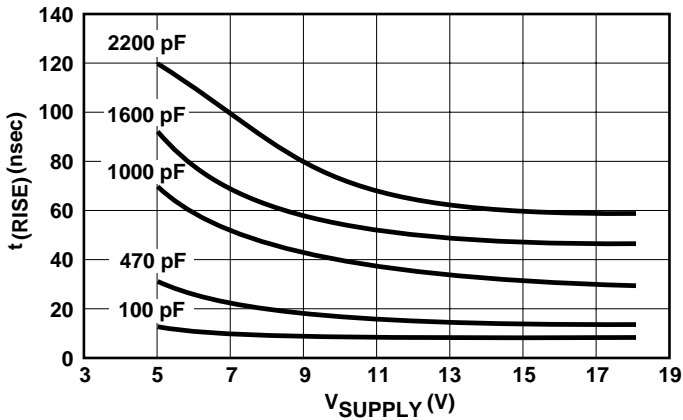

Figure 1. Switching Time Test Circuit

TC4467  
TC4468  
TC4469

TYPICAL CHARACTERISTICS

Rise Time vs. Supply Voltage



Fall Time vs. Supply Voltage

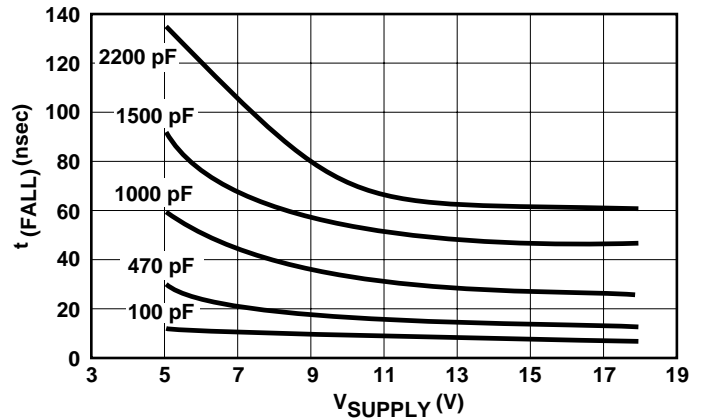

Rise Time vs. Capacitive Load

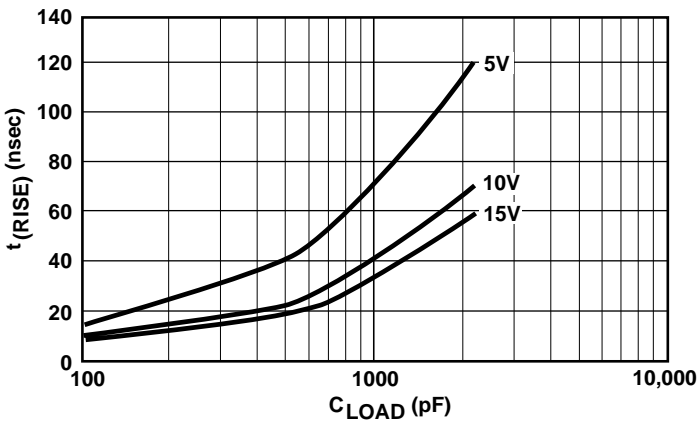

Fall Time vs. Capacitive Load

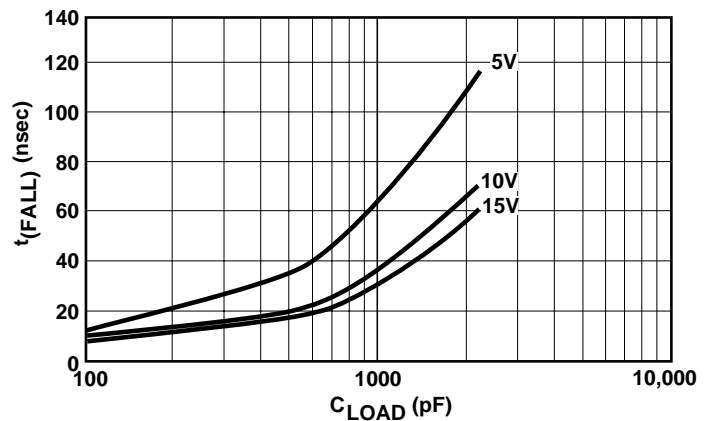

Rise/Fall Times vs. Temperature

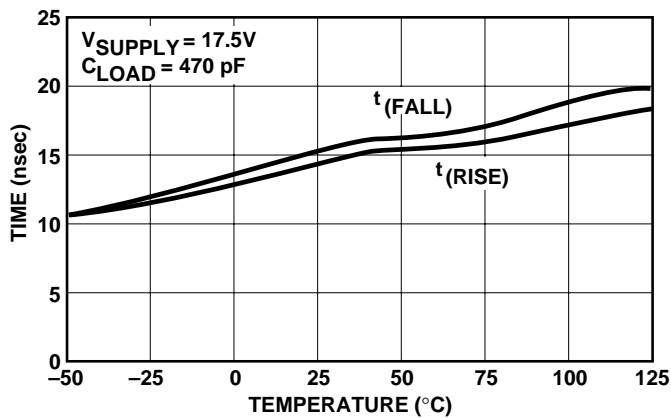

Propagation Delay Time vs. Supply Voltage

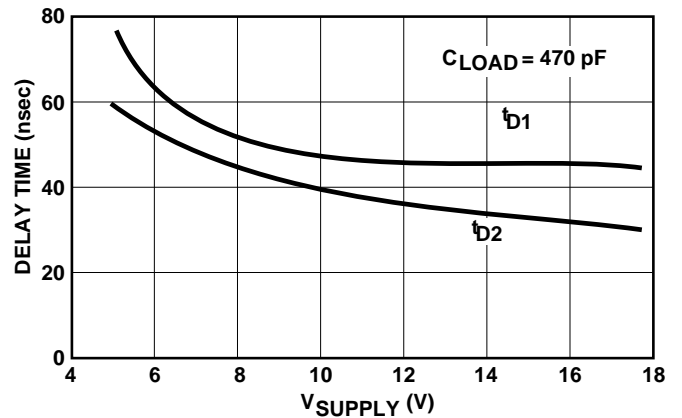

TYPICAL CHARACTERISTICS (Cont.)

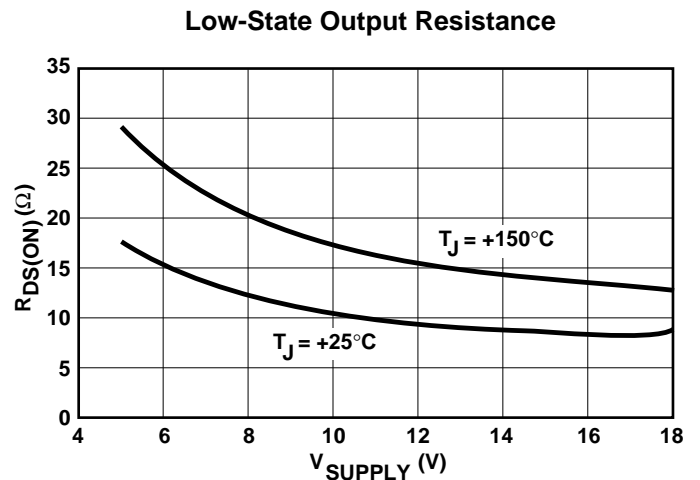
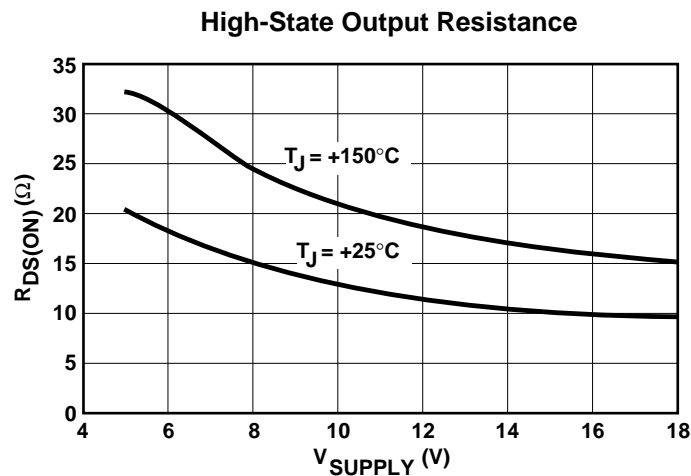
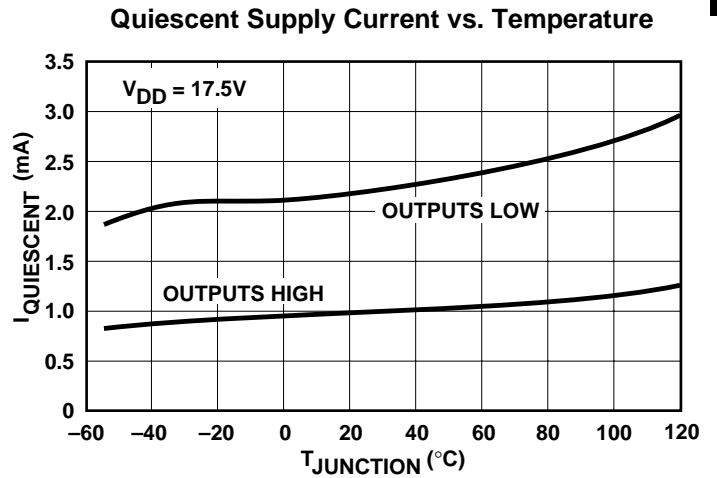
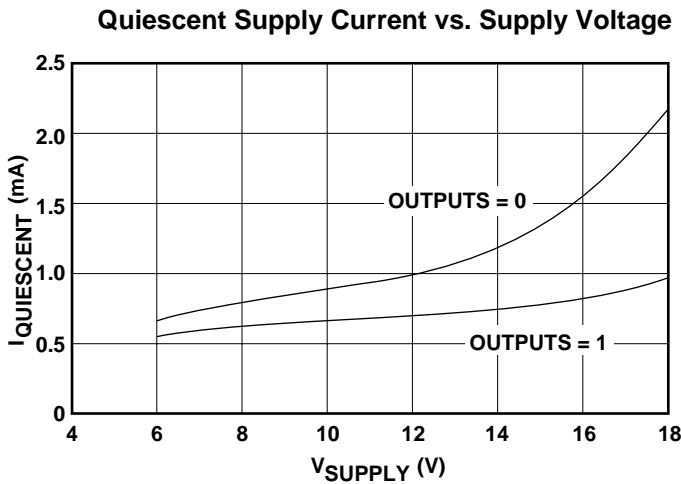
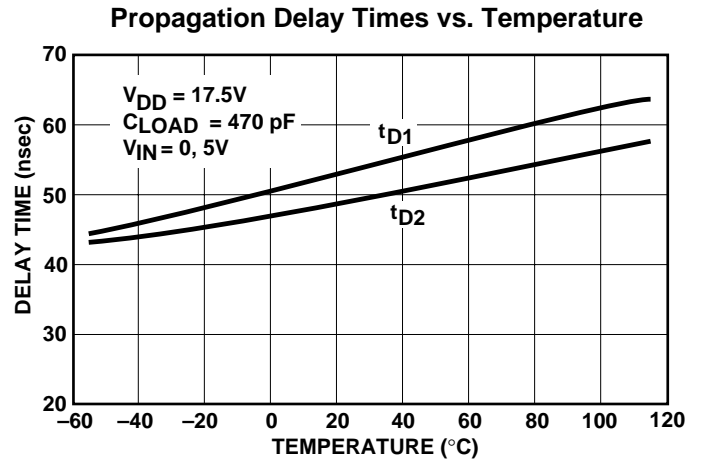
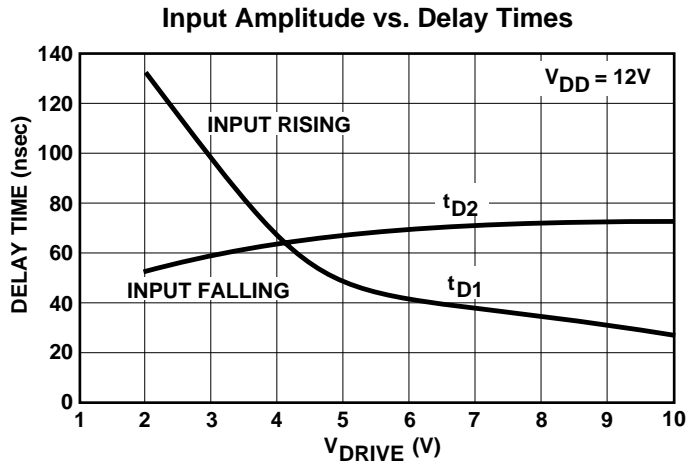

TC4467  
TC4468  
TC4469

SUPPLY CURRENT CHARACTERISTICS (Load on Single Output Only)

Supply Current vs. Capacitive Load

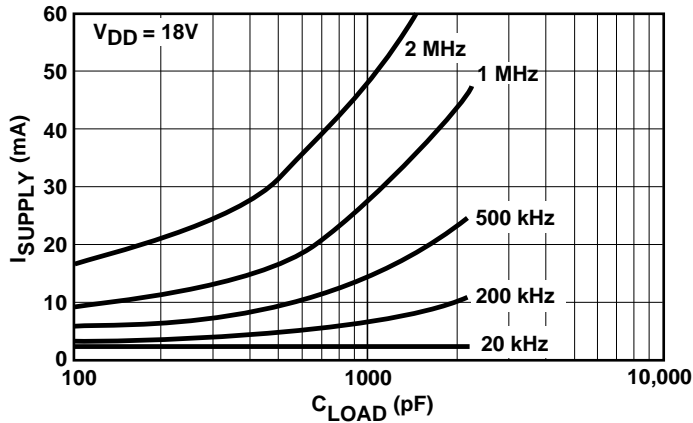

Supply Current vs. Frequency

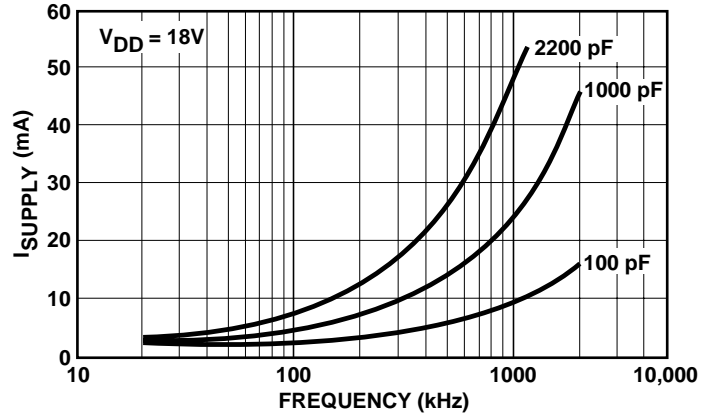

Supply Current vs. Capacitive Load

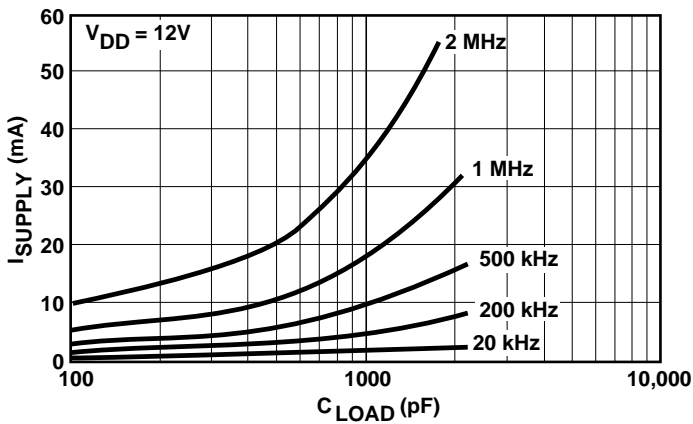

Supply Current vs. Frequency

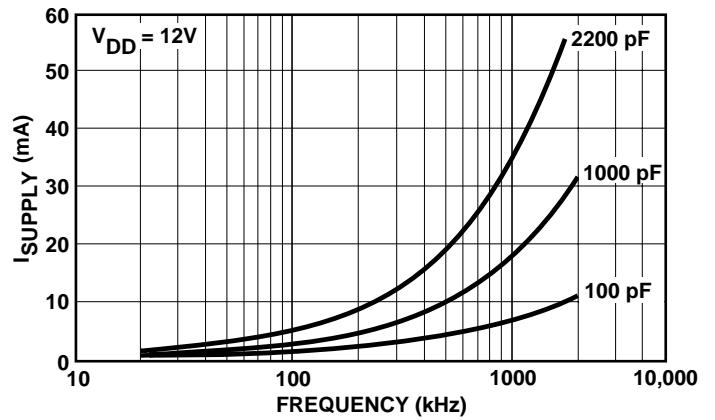

Supply Current vs. Capacitive Load

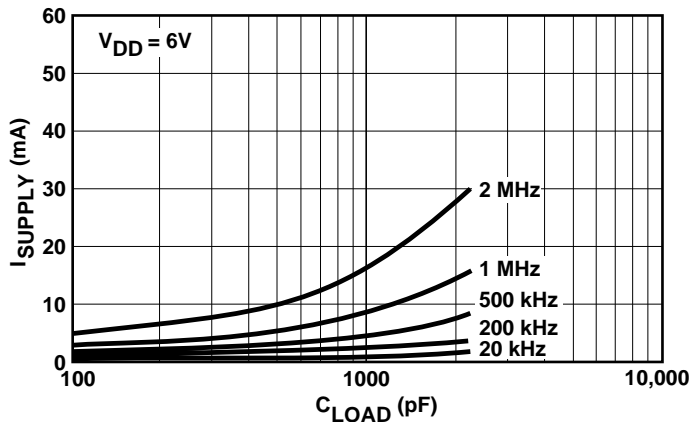

Supply Current vs. Frequency

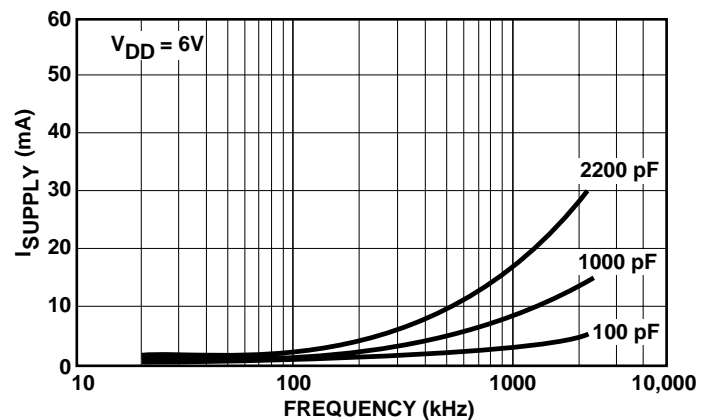



TYPICAL APPLICATIONS

