

1.5A DUAL HIGH-SPEED POWER MOSFET DRIVERS

TC426
TC427
TC428

ABSOLUTE MAXIMUM RATINGS*

Supply Voltage	+20V
Input Voltage, Any Terminal	$V_{DD} + 0.3V$ to $GND - 0.3V$
Power Dissipation ($T_A \leq 70^\circ C$)	
Plastic	730mW
CerDIP	800mW
SOIC	470mW
Derating Factor	
Plastic	8mW/ $^\circ C$

CerDIP	6.4mW/ $^\circ C$
SOIC	4mW/ $^\circ C$
Operating Temperature Range	
C Version	$0^\circ C$ to $+70^\circ C$
I Version	$-25^\circ C$ to $+85^\circ C$
E Version	$-40^\circ C$ to $+85^\circ C$
M Version	$-55^\circ C$ to $+125^\circ C$
Maximum Chip Temperature	$+150^\circ C$
Storage Temperature Range	$-65^\circ C$ to $+150^\circ C$
Lead Temperature (Soldering, 10 sec)	$+300^\circ C$

ELECTRICAL CHARACTERISTICS: $T_A = +25^\circ C$ with $4.5V \leq V_{DD} \leq 18V$, unless otherwise specified.

Symbol	Parameter	Test Conditions	Min	Typ	Max	Unit
Input						
V_{IH}	Logic 1, High Input Voltage		2.4	—	—	V
V_{IL}	Logic 0, Low Input Voltage		—	—	0.8	V
I_{IN}	Input Current	$0V \leq V_{IN} \leq V_{DD}$	-1	—	1	μA
Output						
V_{OH}	High Output Voltage		$V_{DD} - 0.025$	—	—	V
V_{OL}	Low Output Voltage		—	—	0.025	V
R_{OH}	High Output Resistance	$I_{OUT} = 10 \text{ mA}$, $V_{DD} = 18V$	—	10	15	Ω
R_{OL}	Low Output Resistance	$I_{OUT} = 10 \text{ mA}$, $V_{DD} = 18V$	—	6	10	Ω
I_{PK}	Peak Output Current		—	1.5	—	A
Switching Time (Note 1)						
t_R	Rise Time	Test Figure 1/2	—	—	30	nsec
t_F	Fall Time	Test Figure 1/2	—	—	30	nsec
t_{D1}	Delay Time	Test Figure 1/2	—	—	50	nsec
t_{D2}	Delay Time	Test Figure 1/2	—	—	75	nsec
Power Supply						
I_S	Power Supply Current	$V_{IN} = 3V$ (Both Inputs) $V_{IN} = 0V$ (Both Inputs)	— —	— —	8 0.4	 mA mA

ELECTRICAL CHARACTERISTICS: Over Operating Temperature Range with $4.5V \leq V_{DD} \leq 18V$, unless otherwise specified.

Symbol	Parameter	Test Conditions	Min	Typ	Max	Unit
Input						
V_{IH}	Logic 1, High Input Voltage		2.4	—	—	V
V_{IL}	Logic 0, Low Input Voltage		—	—	0.8	V
I_{IN}	Input Current	$0V \leq V_{IN} \leq V_{DD}$	-10	—	10	μA
Output						
V_{OH}	High Output Voltage		$V_{DD} - 0.025$	—	—	V
V_{OL}	Low Output Voltage		—	—	0.025	V
R_{OH}	High Output Resistance	$I_{OUT} = 10 \text{ mA}$, $V_{DD} = 18V$	—	13	20	Ω
R_{OL}	Low Output Resistance	$I_{OUT} = 10 \text{ mA}$, $V_{DD} = 18V$	—	8	15	Ω
Switching Time (Note 1)						
t_R	Rise Time	Test Figure 1/2	—	—	60	nsec
t_F	Fall Time	Test Figure 1/2	—	—	30	nsec
t_{D1}	Delay Time	Test Figure 1/2	—	—	75	nsec
t_{D2}	Delay Time	Test Figure 1/2	—	—	120	nsec
Power Supply						
I_S	Power Supply Current	$V_{IN} = 3V$ (Both Inputs) $V_{IN} = 0V$ (Both Inputs)	— —	— —	12 0.6	 mA mA

NOTE: 1. Switching times guaranteed by design.

*Static-sensitive device. Unused devices must be stored in conductive material. Protect devices from static discharge and static fields. Stresses above those listed under "Absolute Maximum Ratings" may cause permanent damage to the device. These are stress ratings only, and functional

operation of the device at these or any other conditions above those indicated in the operational sections of the specifications is not implied. Exposure to absolute maximum rating conditions for extended periods may effect device reliability.

SUPPLY BYPASSING

Charging and discharging large capacitive loads quickly requires large currents. For example, charging a 1000-pF load to 18V in 25nsec requires an 0.72A current from the device power supply.

To guarantee low supply impedance over a wide frequency range, a parallel capacitor combination is recommended for supply bypassing. Low-inductance ceramic disk capacitors with short lead lengths (< 0.5 in.) should be used. A 1 μ F film capacitor in parallel with one or two 0.1 μ F ceramic disk capacitors normally provides adequate bypassing.

GROUNDING

The TC426 and TC428 contain inverting drivers. Ground potential drops developed in common ground impedances from input to output will appear as negative feedback and degrade switching speed characteristics.

Individual ground returns for the input and output circuits or a ground plane should be used.

INPUT STAGE

The input voltage level changes the no-load or quiescent supply current. The N-channel MOSFET input stage transistor drives a 2.5mA current source load. With a logic "1" input, the maximum quiescent supply current is 8 mA. Logic "0" input level signals reduce quiescent current to 0.4 mA maximum. Minimum power dissipation occurs for logic "0" inputs for the TC426/427/428. **Unused driver inputs must be connected to V_{DD} or GND.**

The drivers are designed with 100 mV of hysteresis. This provides clean transitions and minimizes output stage current spiking when changing states. Input voltage thresholds are approximately 1.5V, making the device TTL compatible over the 4.5V to 18V supply operating range. Input current is less than 1 μ A over this range.

The TC426/427/428 may be directly driven by the TL494, SG1526/1527, SG1524, SE5560, and similar switch-mode power supply integrated circuits.

POWER DISSIPATION

The supply current vs frequency and supply current vs capacitive load characteristic curves will aid in determining power dissipation calculations.

The TC426/427/428 CMOS drivers have greatly reduced quiescent DC power consumption. Maximum quiescent current is 8 mA compared to the DS0026 40 mA specification. For a 15V supply, power dissipation is typically 40 mW.

Two other power dissipation components are:

- Output stage AC and DC load power.
- Transition state power.

Output stage power is:

$$P_o = P_{DC} + P_{AC}$$

$$= V_o (I_{DC}) + f C_L V_s$$

Where:

- V_o = DC output voltage
- I_{DC} = DC output load current
- f = Switching frequency
- V_s = Supply voltage

In power MOSFET drive applications the P_{DC} term is negligible. MOSFET power transistors are high impedance, capacitive input devices. In applications where resistive loads or relays are driven, the P_{DC} component will normally dominate.

The magnitude of P_{AC} is readily estimated for several cases:

- | | | | |
|----|---|----|--|
| A. | 1. f = 20kHz
2. C_L = 1000pf
3. V_s = 18V
4. P_{AC} = 65mW | B. | 1. f = 200kHz
2. C_L = 1000pf
3. V_s = 15V
4. P_{AC} = 45mW |
|----|---|----|--|

During output level state changes, a current surge will flow through the series connected N and P channel output MOSFETS as one device is turning "ON" while the other is turning "OFF". The current spike flows only during output transitions. The input levels should not be maintained between the logic "0" and logic "1" levels. **Unused driver inputs must be tied to ground and not be allowed to float.** Average power dissipation will be reduced by minimizing input rise times. As shown in the characteristic curves, average supply current is frequency dependent.

1.5A DUAL HIGH-SPEED POWER MOSFET DRIVERS

TC426
TC427
TC428

TYPICAL CHARACTERISTICS

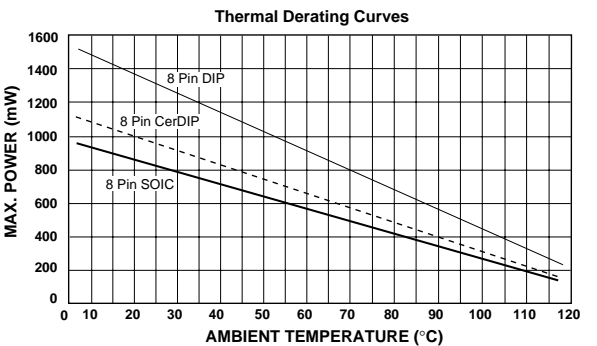
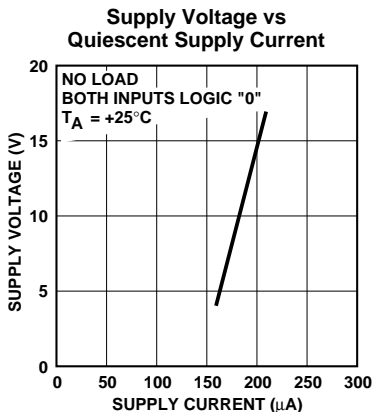
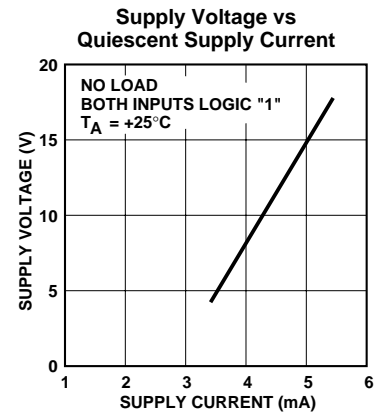
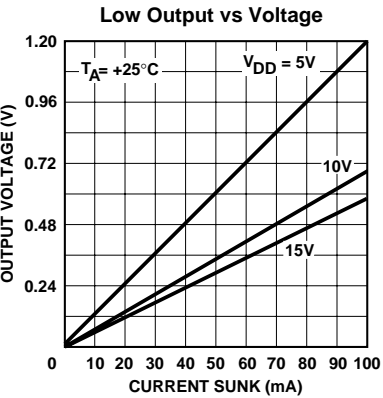
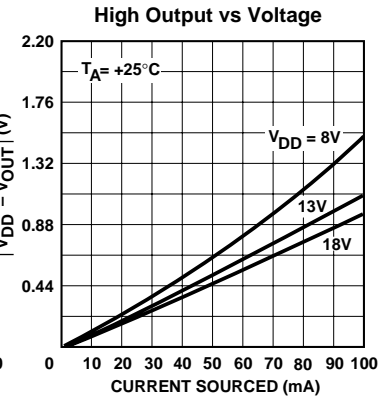
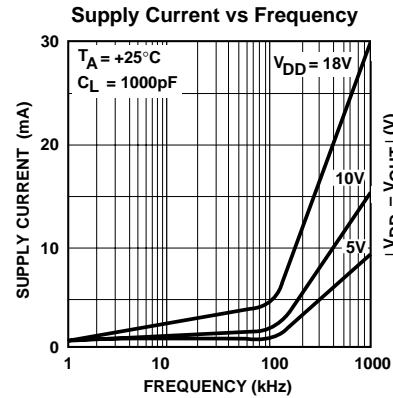
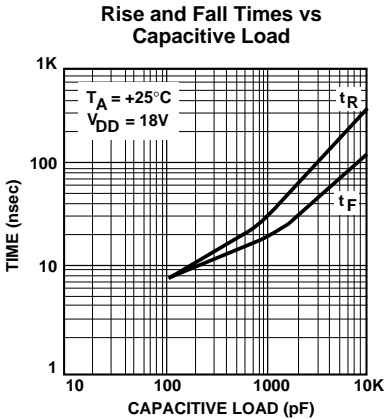
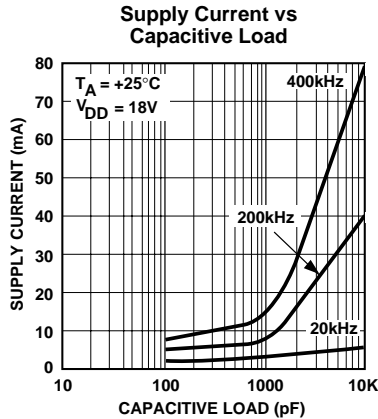
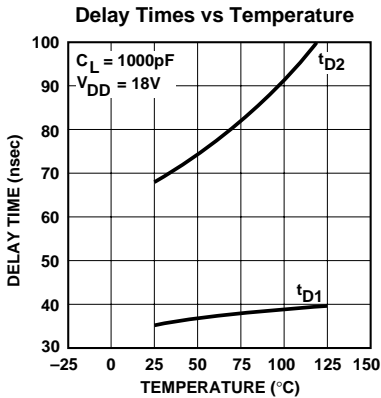
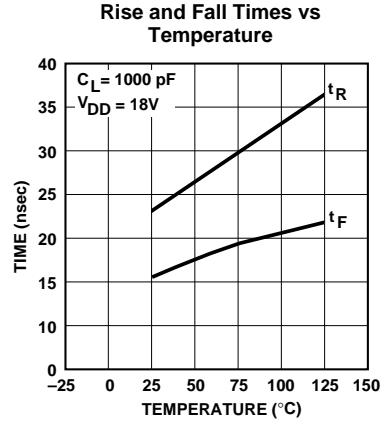
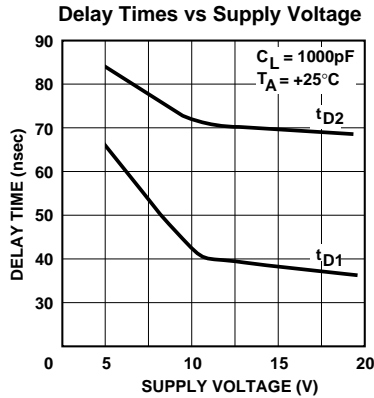
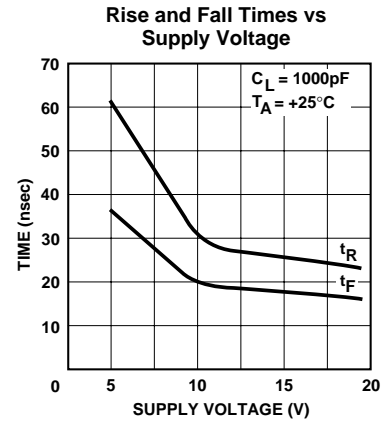

1.5A DUAL HIGH-SPEED POWER MOSFET DRIVERS

TC426
TC427
TC428

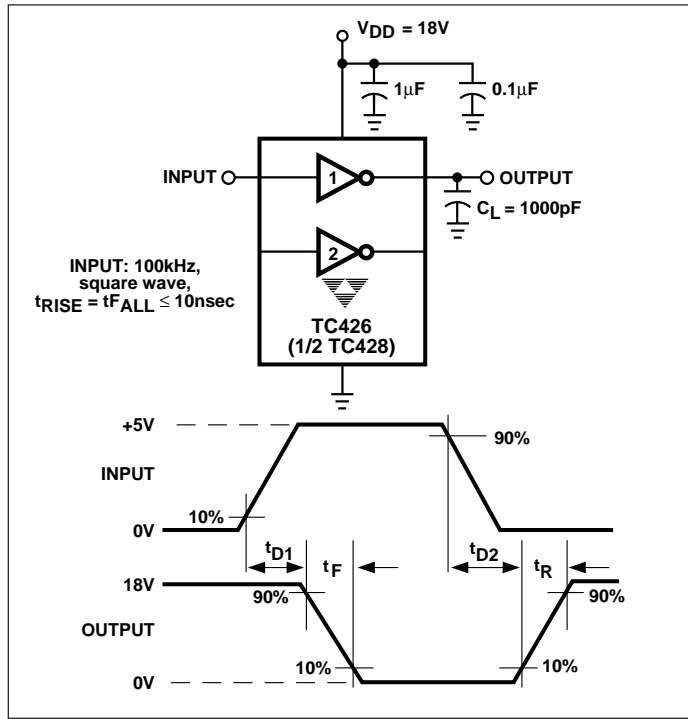

Test Figure 1. Inverting Driver Switching Time Test Circuit

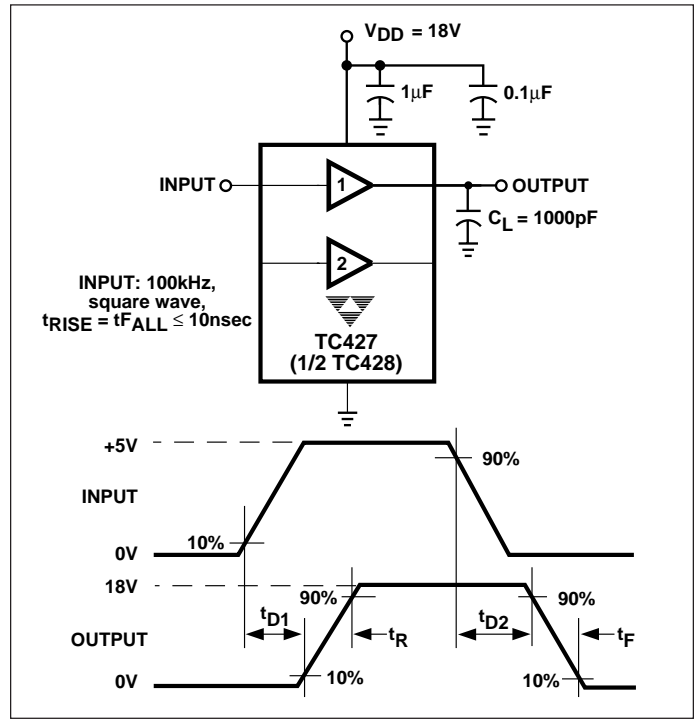

Test Figure 2. Noninverting Driver Switching Time Test Circuit

4

VOLTAGE DOUBLER

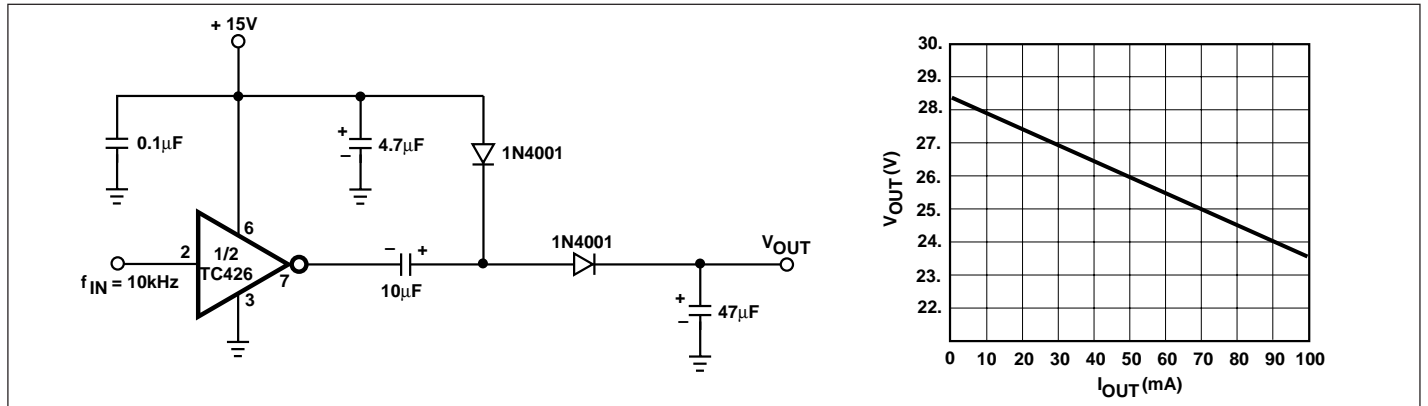

VOLTAGE INVERTER

