

#### THREE TERMINAL POSITIVE VOLTAGE REGULATORS 5V, 8V, 12V, 15V.

KIA78M × × Series of three-terminal positive voltage regulators employ built-in current limiting, thermal shutdown, and safe-operating area protection which makes them virtually immune to damage from output overloads. With adequate heatsinking, they can deliver in excess of 0.5A output current.

#### FEATURES

- Output current in excess of 0.5A.
- No external components.
- Internal thermal overload protection.
- Internal short circuit current limiting.
- Output transistor safe-area compensation.
- Available in TO-126 package.

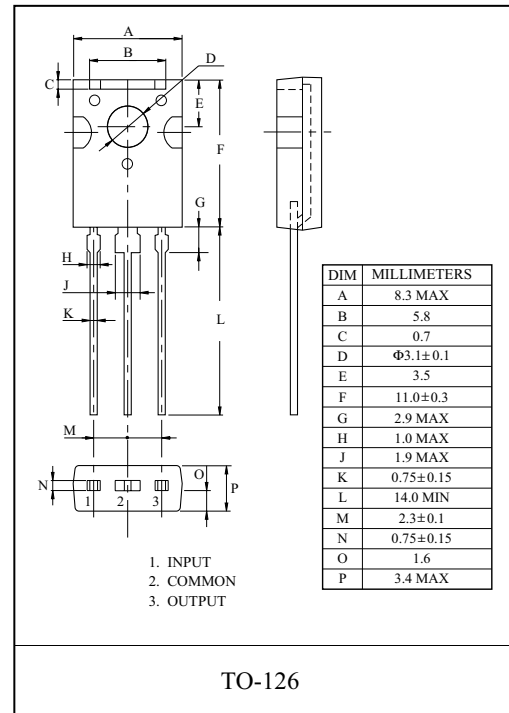

#### MAXIMUM RATINGS (Ta=25 °C)

CHARACTERISTIC	SYMBOL	RATING	UNIT
Input Voltage	V <sub>IN</sub>	35	V
Power Dissipation (Tc=25 °C)	P <sub>D</sub>	15	W
Power Dissipation (Without Heatsink)	P <sub>D</sub>	1.5	W
Operating Junction Temperature	T <sub>j</sub>	-40 ~ 150	°C
Storage Temperature	T <sub>stg</sub>	-55 ~ 150	°C
Soldering Temperature (10 seconds)	T <sub>sol</sub>	260	°C

# KIA78M05T ~ KIA78M15T

## EQUIVALENT CIRCUIT

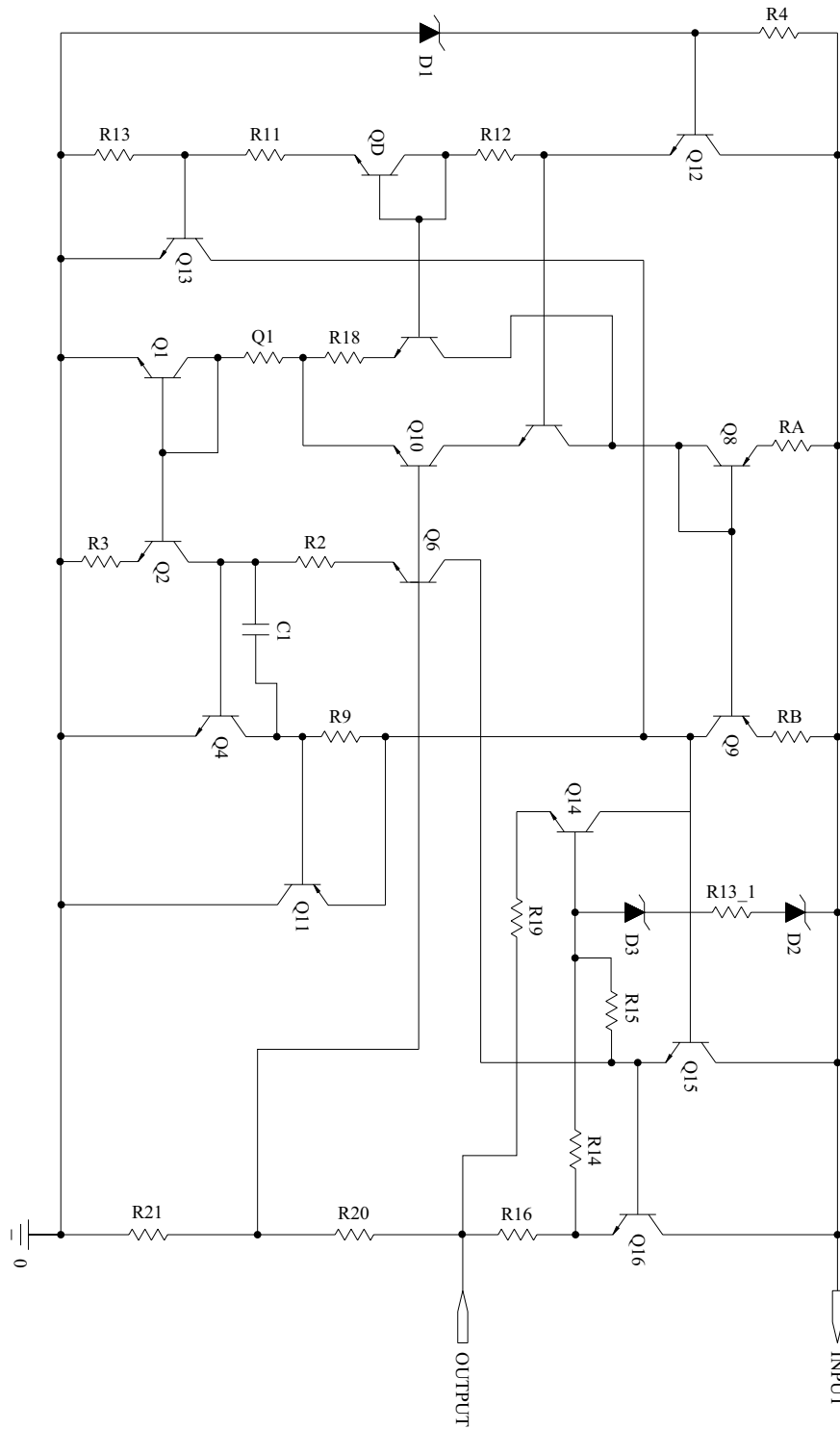

# KIA78M05T ~ KIA78M15T

## ELECTRICAL CHARACTERISTICS

### KIA78M05T

(unless otherwise specified :  $V_{IN}=10V$ ,  $I_O=350mA$ ,  $C_{IN}=0.33\mu F$ ,  $C_O=0.1\mu F$ )

CHARACTERISTIC	SYMBOL	TEST CONDITION	MIN.	TYP.	MAX.	UNIT
Output Voltage	$V_{OUT}$	$T_j=25^\circ C$	4.8	5.0	5.2	V
		$5mA \leq I_{OUT} \leq 350mA$ $P_D \leq 7.5W, 7.5V \leq V_{IN} \leq 20V$	4.75	5.0	5.25	
Line Regulation	Reg Line	$8V \leq V_{IN} \leq 25V, I_{OUT}=200mA$	-	-	50	mV
		$7.2V \leq V_{IN} \leq 25V, I_{OUT}=200mA$	-	-	100	
Load Regulation	Reg Load	$5mA \leq I_{OUT} \leq 500mA$	-	-	100	mV
Quiescent Current	$I_B$	$T_j=25^\circ C$	-	4	6	mA
Quiescent Current Change	$\Delta I_B$	$5mA \leq I_{OUT} \leq 350mA$	-	-	0.5	mA
		$7.5V \leq V_{IN} \leq 25V, I_{OUT}=200mA$	-	-	1.0	mA
Output Noise Voltage	$V_{NO}$	$f=10Hz \sim 100kHz$	-	40	-	$\mu V$
Ripple Rejection	R · R	$f=120Hz, 8V \leq V_{IN} \leq 18V$ $I_{OUT}=300mA$	62	78	-	dB
Dropout Voltage	$V_D$	$I_{OUT}=500mA$	-	2.0	-	V
Short Circuit Current	$I_{SC}$	$V_{IN}=35V$	-	300	-	mA
Output Voltage Drift	$\Delta V_{OUT}/\Delta T$	$I_{OUT}=5mA, T_j=0 \sim 125^\circ C$	-	-0.5	-	mV/°C

# KIA78M05T ~ KIA78M15T

## ELECTRICAL CHARACTERISTICS

### KIA78M08T

(unless otherwise specified :  $V_{IN}=14V$ ,  $I_O=350mA$ ,  $C_{IN}=0.33\mu F$ ,  $C_O=0.1\mu F$ )

CHARACTERISTIC	SYMBOL	TEST CONDITION	MIN.	TYP.	MAX.	UNIT
Output Voltage	$V_{OUT}$	$T_j=25^\circ C$	7.7	8	8.3	V
		$5mA \leq I_{OUT} \leq 350mA$ $P_D \leq 7.5W$ , $10.5V \leq V_{IN} \leq 23V$	7.6	8	8.4	
Line Regulation	Reg Line	$11V \leq V_{IN} \leq 25V$ , $I_{OUT}=200mA$	-	-	50	mV
		$10.5V \leq V_{IN} \leq 25V$ , $I_{OUT}=200mA$	-	-	100	
Load Regulation	Reg Load	$5mA \leq I_{OUT} \leq 500mA$	-	-	100	mV
Quiescent Current	$I_B$	$T_j=25^\circ C$	-	4	6	mA
Quiescent Current Change	$\Delta I_B$	$5mA \leq I_{OUT} \leq 350mA$	-	-	0.5	mA
		$10.5V \leq V_{IN} \leq 25V$ , $I_{OUT}=200mA$	-	-	1.0	mA
Output Noise Voltage	$V_{NO}$	$f=10Hz \sim 100kHz$	-	50	-	$\mu V$
Ripple Rejection	R · R	$f=120Hz$ , $11V \leq V_{IN} \leq 25V$ $I_{OUT}=300mA$	56	75	-	dB
Dropout Voltage	$V_D$	$I_{OUT}=500mA$	-	2.0	-	V
Short Circuit Current	$I_{SC}$	$V_{IN}=35V$	-	300	-	mA
Output Voltage Drift	$\Delta V_{OUT} / \Delta T$	$I_{OUT}=5mA$ , $T_j=0 \sim 125^\circ C$	-	-0.5	-	mV/°C

# KIA78M05T ~ KIA78M15T

## ELECTRICAL CHARACTERISTICS

### KIA78M12T

(unless otherwise specified :  $V_{IN}=19V$ ,  $I_O=350mA$ ,  $C_{IN}=0.33\mu F$ ,  $C_O=0.1\mu F$ )

CHARACTERISTIC	SYMBOL	TEST CONDITION	MIN.	TYP.	MAX.	UNIT
Output Voltage	$V_{OUT}$	$T_j=25^\circ C$	11.5	12	12.5	V
		$5mA \leq I_{OUT} \leq 350mA$ $P_D \leq 7.5W$ , $14.8V \leq V_{IN} \leq 27V$	11.4	12	12.6	
Line Regulation	Reg Line	$16V \leq V_{IN} \leq 30V$ , $I_{OUT}=200mA$	-	-	50	mV
		$14.5V \leq V_{IN} \leq 30V$ , $I_{OUT}=200mA$	-	-	100	
Load Regulation	Reg Load	$5mA \leq I_{OUT} \leq 500mA$	-	-	240	mV
Quiescent Current	$I_B$	$T_j=25^\circ C$	-	4	6	mA
Quiescent Current Change	$\Delta I_B$	$5mA \leq I_{OUT} \leq 350mA$	-	-	0.5	mA
		$14.5V \leq V_{IN} \leq 25V$ , $I_{OUT}=200mA$	-	-	1.0	mA
Output Noise Voltage	$V_{NO}$	$f=10Hz \sim 100kHz$	-	75	-	$\mu V$
Ripple Rejection	R · R	$f=120Hz$ , $15V \leq V_{IN} \leq 25V$ $I_{OUT}=300mA$	55	75	-	dB
Dropout Voltage	$V_D$	$I_{OUT}=500mA$	-	2.0	-	V
Short Circuit Current	$I_{SC}$	$V_{IN}=35V$	-	300	-	mA
Output Voltage Drift	$\Delta V_{OUT}/\Delta T$	$I_{OUT}=5mA$ , $T_j=0 \sim 125^\circ C$	-	-0.5	-	mV/°C

# KIA78M05T ~ KIA78M15T

## ELECTRICAL CHARACTERISTICS

### KIA78M15T

(unless otherwise specified :  $V_{IN}=23V$ ,  $I_O=350mA$ ,  $C_{IN}=0.33\mu F$ ,  $C_O=0.1\mu F$ )

CHARACTERISTIC	SYMBOL	TEST CONDITION	MIN.	TYP.	MAX.	UNIT
Output Voltage	$V_{OUT}$	$T_j=25^\circ C$	14.4	15	15.6	V
		$5mA \leq I_{OUT} \leq 350mA$ $P_D \leq 7.5W$ , $18V \leq V_{IN} \leq 30V$	14.25	15	15.75	
Line Regulation	Reg Line	$20V \leq V_{IN} \leq 30V$ , $I_{OUT}=200mA$	-	-	50	mV
		$17.5V \leq V_{IN} \leq 30V$ , $I_{OUT}=200mA$	-	-	100	
Load Regulation	Reg Load	$5mA \leq I_{OUT} \leq 500mA$	-	-	300	mV
Quiescent Current	$I_B$	$T_j=25^\circ C$	-	4	6	mA
Quiescent Current Change	$\Delta I_B$	$5mA \leq I_{OUT} \leq 350mA$	-	-	0.5	mA
		$18V \leq V_{IN} \leq 30V$ , $I_{OUT}=200mA$	-	-	1.0	mA
Output Noise Voltage	$V_{NO}$	$f=10Hz \sim 100kHz$	-	90	-	$\mu V$
Ripple Rejection	R · R	$f=120Hz$ , $18.5V \leq V_{IN} \leq 28.5V$ $I_{OUT}=300mA$	54	70	-	dB
Dropout Voltage	$V_D$	$I_{OUT}=500mA$	-	2.0	-	V
Short Circuit Current	$I_{SC}$	$V_{IN}=35V$	-	300	-	mA
Output Voltage Drift	$\Delta V_{OUT} / \Delta T$	$I_{OUT}=5mA$ , $T_j=0 \sim 125^\circ C$	-	-1	-	mV/°C

# KIA78M05T ~ KIA78M15T

PEAK OUTPUT CURRENT

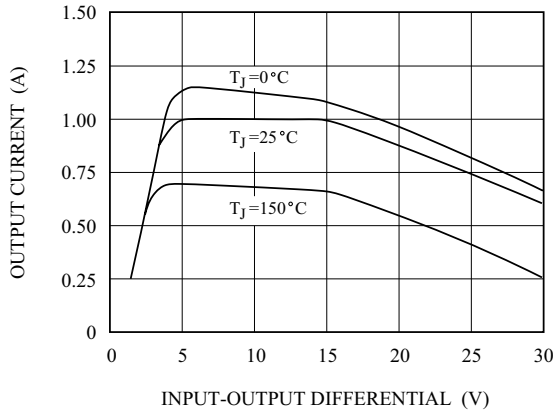

RIPPLE REJECTION

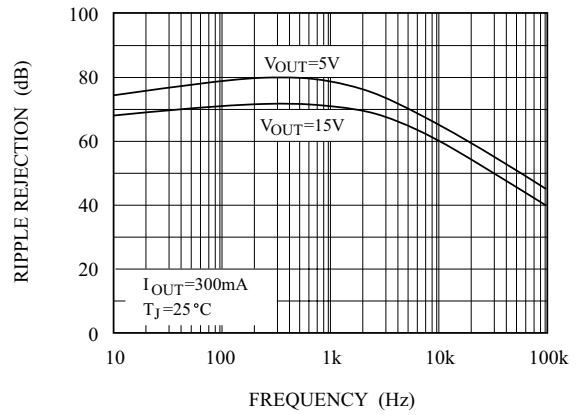

DROPOUT VOLTAGE

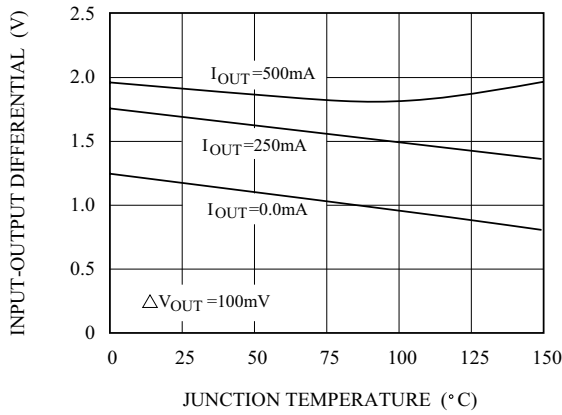

OUTPUT VOLTAGE  
(Normalized to 1V at  $T_J = 25^\circ\text{C}$ )

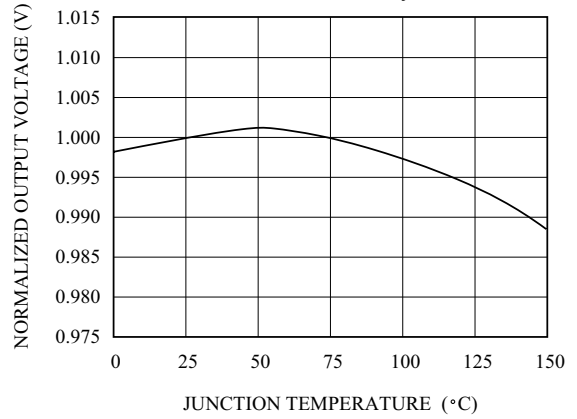

QUIESCENT CURRENT

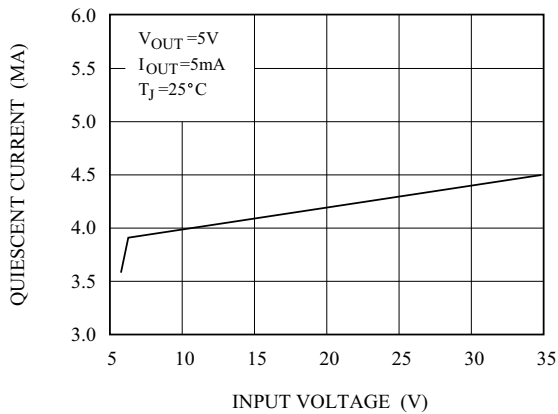

QUIESCENT CURRENT

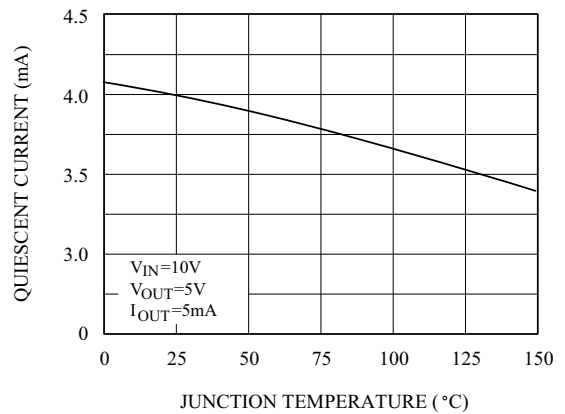

# KIA78M05T ~ KIA78M15T

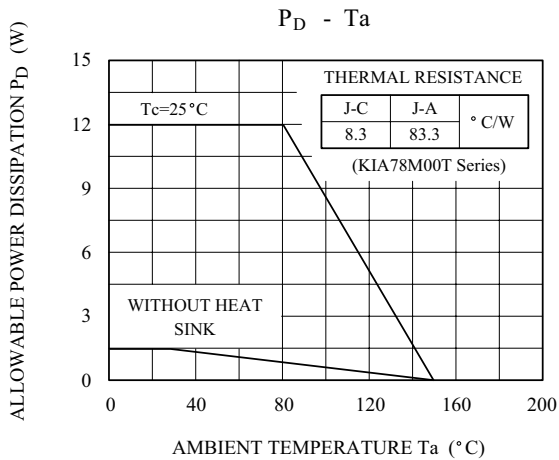

## Design Considerations

The KIA78MXX fixed voltage regulator series has built-in thermal overload protection which prevents the device from being damaged due to excessive junction temperature.

The regulators also contain internal short-circuit protection which limits the maximum output current, and safe-area protection for the pass transistor which reduces the short circuit current as the voltage across the pass transistor is increased. Although the internal

power dissipation is automatically limited, the maximum junction temperature of the device must be kept below +150 °C in order to meet data sheet specifications.

An adequate heatsink should be provided to assure this limit is not exceeded under worst-case operating conditions (maximum input voltage and load current) if reliable performance is to be obtained.

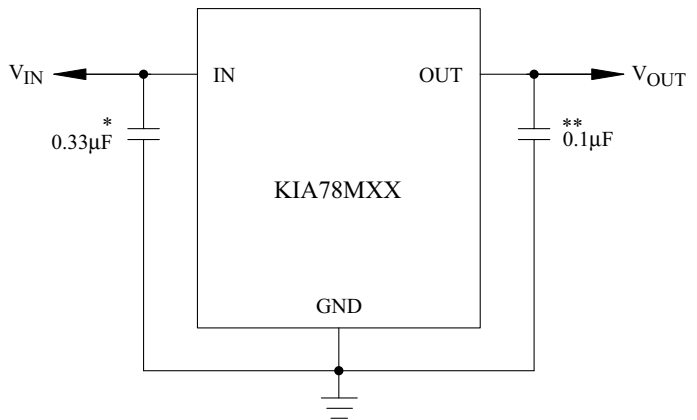

\* Required if regulator input is more than 4 inches from input filter capacitor.

(or if no input filter capacitor is used).

\*\* Optional for improved transient response.