

TOSHIBA CMOS DIGITAL INTEGRATED CIRCUIT SILICON MONOLITHIC

**TC9307AF-014****SINGLECHIP DTS MICRO CONTROLLER (DTS-12)**

The TC9307AF-014 is a digital tuning system optimum for such portable audio equipment as radio with a cassette tape recorder, and is provided with 4 bands of FM/SW/MW/LW and compatible with worldwide destinations.

## ○ RECEIVING BAND

AREA	CODE			STEP JAMPER	BAND	RECEIVING FREQUENCY [Hz]	STEP [Hz]	REFERENCE FREQUENCY [Hz]	INTERMEDIATE FREQUENCY [Hz]
	E0	E1	E2						
USA1	0	0	0	—	FM	87.5 ~ 107.9M	200k	25k	+ 10.7M
					MW	530 ~ 1710k	10k	5k	+ 450k
USA2	0	0	1	—	FM	87.5 ~ 108.0M	100k	25k	+ 10.7M
					MW	530 ~ 1710k	10k	5k	+ 450k
GENERAL SW-A	0	1	0	0 / 1	FM	87.50 ~ 108.00M	50 / 100k	25k	+ 10.7M
				0	MW	531 ~ 1602k	9k	3k	+ 450k
				1		530 ~ 1610k	10k	5k	
				—	LW	146 ~ 281k	1k	1k	
				—	SW	5.95 ~ 15.6M	5k	5k	
EUROPE	0	1	1	0 / 1	FM	87.50 ~ 108.00M	50 / 100k	25k	
				0	MW	531 ~ 1602k	9k	3k	+ 450k
				1		530 ~ 1610k	10k	5k	
				—	LW	146 ~ 281k	1k	1k	
MIDDLE EAST	1	0	0	0 / 1	FM	87.50 ~ 108.00M	50 / 100k	25k	+ 10.7M
				0	MW	531 ~ 1602k	9k	3k	+ 450k
				1		530 ~ 1610k	10k	5k	
				—	SW <sub>1</sub>	2.3 ~ 6.2M	5k	5k	
—	SW <sub>2</sub>	7.1 ~ 21.85M							
GENERAL SW-B	1	0	1	0 / 1	FM	87.50 ~ 108.00M	50 / 100k	25k	+ 10.7M
				0	MW	531 ~ 1602k	9k	3k	+ 450k
				1		530 ~ 1610k	10k	5k	
				—	LW	146 ~ 281k	1k	1k	
				—	SW	3.8 ~ 12.5M	5k	5k	
AUST- RALIA	1	1	0	0 / 1	FM	87.50 ~ 108.00M	50 / 100k	25k	
				0	MW	531 ~ 1602k	9k	3k	+ 450k
				1		530 ~ 1610k	10k	5k	
CHINA	1	1	1	0 / 1	FM	87.00 ~ 108.00M	50 / 100k	25k	+ 10.7M
				—	MW	522 ~ 1611k	9k	3k	+ 450k
				—	SW <sub>1</sub>	2.3 ~ 6.2M	5k	5k	
				—	SW <sub>2</sub>	7.1 ~ 21.85M			

980910EBA2

● TOSHIBA is continually working to improve the quality and the reliability of its products. Nevertheless, semiconductor devices in general can malfunction or fail due to their inherent electrical sensitivity and vulnerability to physical stress. It is the responsibility of the buyer, when utilizing TOSHIBA products, to observe standards of safety, and to avoid situations in which a malfunction or failure of a TOSHIBA product could cause loss of human life, bodily injury or damage to property. In developing your designs, please ensure that TOSHIBA products are used within specified operating ranges as set forth in the most recent products specifications. Also, please keep in mind the precautions and conditions set forth in the TOSHIBA Semiconductor Reliability Handbook.

● The products described in this document are subject to the foreign exchange and foreign trade laws.

● The information contained herein is presented only as a guide for the applications of our products. No responsibility is assumed by TOSHIBA CORPORATION for any infringements of intellectual property or other rights of the third parties which may result from its use. No license is granted by implication or otherwise under any intellectual property or other rights of TOSHIBA CORPORATION or others.

● The information contained herein is subject to change without notice.

## ○ TUNING FUNCTION

- Manual UP/DOWN Tuning
- Auto UP/DOWN Tuning (IF counter auto stop function)
- Auto Tuning in SW band is the scan system in the meter band.
- Memory scan tuning.
- Band changeover of method is selectable momentary lock switch.

## ○ MEMORY FUNCTION

FM/MW	10/10	USA1, USA2, Australia
FM/MW/LW	10/5/5	Europe
FM/MW/LW/SW	10/5/5/5	General SW-A, General SW-B
FM/MW/SW <sub>1</sub> /SW <sub>2</sub>	5/5/5/5	Middle-East, China

## ○ 12-hour/24-hour Clock

- ON/OFF timer by time set system
- Snooze function (within 2 hours)
- Sleep timer (max. 90 min.)

TC9307AF-014 Layout

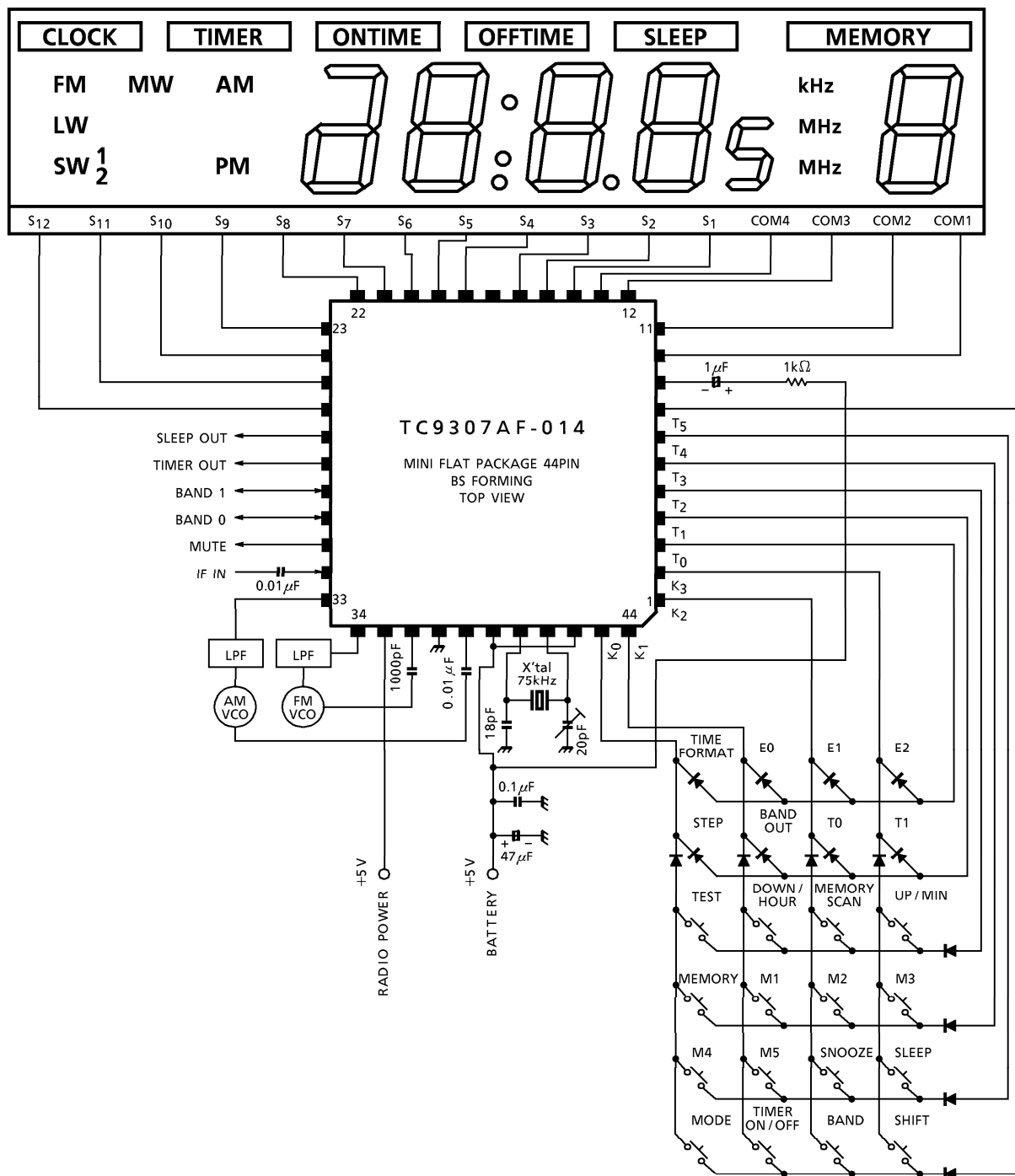

**KEY MAP**

	T0	T1	T2	T3	T4	T5
k3	*E2	*T1	UP min	M3	SLEEP	SHIFT
k2	*E1	*T0	MEMORY SCAN	M2	SNOOZE	BAND
k1	*E0	*BAND OUT	DOWN hour	M1	M5	TIMER ON / OFF
k0	*TIME FORMAT	*9k 10k	TEST	MEMORY	M4	MODE

\* Diode jumper

**LCD MAP**

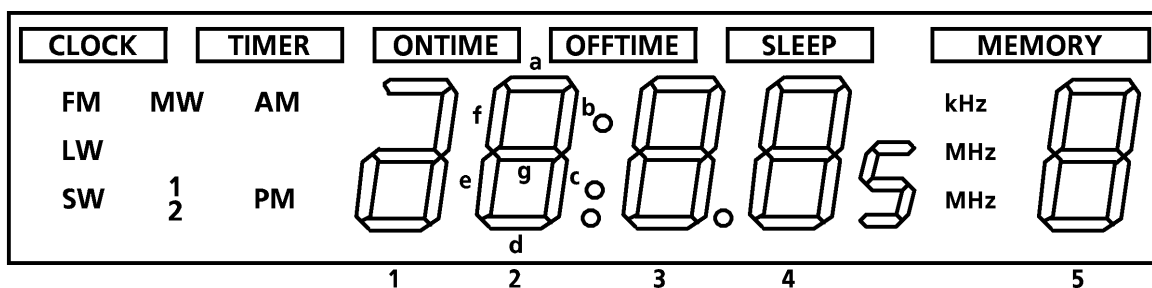

SYMBOL	PIN No.	SEGMENT NAME				COMMENT
		COM1	COM2	COM3	COM4	
S12	26	5	FM. MHz	kHz	PM	21.845MHz
S11	25	SW. MHz	:	2	CLOCK	SW 2
S10	24	MW	1	LW	AM	SW 1
S9	23	1c	1 adge	1b	TIMER	21.845MHz
S8	22	2d	2e	2f	ON-TIME	21.845MHz
S7	21	2c	2g	2b	2a	
S6	20	3d	3e	3f	OFF-TIME	21.845MHz
S5	19	3c	3g	3b	3a	
S4	18	4d	4e	4f	SLEEP	21.845MHz
S3	16	4c	4g	4b	4a	
S2	15	5d	5e	5f	MEMORY	PRESET CH
S1	14	5c	5g	5b	5a	

## PUSH KEY

SYMBOL	FUNCTIONAL DESCRIPTION
UP min	FREQ : Press briefly, frequency will be advanced by one step at each time this button pressed. Press continuously for more than 1 second, seek-up tuning mode is result. Scanner looks for the nearest station with sufficient signal strength. TIME : When correcting a time or setting a timer, MINUTE digit is set.
MEMORY SCAN	Calls and receivings the preset memory in order.
DOWN hour	FREQ : Press briefly, frequency will be advanced by one step at each time this button pressed. Press continuously for more than 1 second, seek-down tuning mode is result. Scanner looks for the nearest station with sufficient signal strength. TIME : When correcting a time or setting a timer, HOUR digit is set.
MEMORY	FREQ : While this button is pressed, memory write function is enabled for a time period of 4 second. After the time period, memory write function will disable automatically. TIME : Continuously pressing this button will enable time or timer correction function. Time or timer correction function will be disable again once this button is released. This is a security function to avoid misalignment of the time or timer accidentally.
BAND	When [BAND OUT] jumper is valid, briefly press this button will alter the radio band in a cyclic function.
M1~M5	Address to memory location when recall a preset memory or write to a memory.
SHIFT	For some destinations, 10 preset memories is provided. [SHIFT] key is useful for the addressing of M6-M10. To do so, push SHIFT key and then push M1-M5.
TEST	As long as this key is kept pushed, all indications on LCD are kept on. Further, this is capable of checking the timer and sleep functions by accelerating the clock.
SNOOZE	To temporary stop the timer function for a time interval of 9 min. After this time interval, timer function will resume.
SLEEP	SLEEP timer can be turned ON and OFF by a momentarily switch in a cyclic function. To alter the sleep time, push SLEEP button to activate the SLEEP timer and continuously pushing this button for more than 1 second, a sleep time can be set up at an interval of 0.5 second /step like 90, 80,..... 10, 1, 90.
MODE	Switches the operation among FREQUENCY, CLOCK and TIMER mode cyclically.

FUNCTION (DIODE JUMPER)

SYMBOL	FUNCTIONAL DESCRIPTION																																							
E0~E2	<p>Set up a destination</p> <table border="1"> <thead> <tr> <th colspan="3">DIODE</th> <th rowspan="2">DESTINATION</th> </tr> <tr> <th>E0</th> <th>E1</th> <th>E2</th> </tr> </thead> <tbody> <tr> <td></td> <td></td> <td></td> <td>USA1</td> </tr> <tr> <td></td> <td></td> <td>○</td> <td>USA1</td> </tr> <tr> <td></td> <td>○</td> <td></td> <td>General (SW-A type)</td> </tr> <tr> <td></td> <td>○</td> <td>○</td> <td>Europe</td> </tr> <tr> <td>○</td> <td></td> <td></td> <td>Middle &amp; Near East</td> </tr> <tr> <td>○</td> <td></td> <td>○</td> <td>General (SW-B type)</td> </tr> <tr> <td>○</td> <td>○</td> <td></td> <td>Canada Australia</td> </tr> <tr> <td>○</td> <td>○</td> <td>○</td> <td>China</td> </tr> </tbody> </table> <p>○ : Diode is available</p>	DIODE			DESTINATION	E0	E1	E2				USA1			○	USA1		○		General (SW-A type)		○	○	Europe	○			Middle & Near East	○		○	General (SW-B type)	○	○		Canada Australia	○	○	○	China
DIODE			DESTINATION																																					
E0	E1	E2																																						
			USA1																																					
		○	USA1																																					
	○		General (SW-A type)																																					
	○	○	Europe																																					
○			Middle & Near East																																					
○		○	General (SW-B type)																																					
○	○		Canada Australia																																					
○	○	○	China																																					
T0 T1	<table border="1"> <thead> <tr> <th>T1</th> <th>T0</th> <th>CLOCK</th> <th>TIMER</th> <th>SNOOZE</th> </tr> </thead> <tbody> <tr> <td>0</td> <td>0</td> <td>×</td> <td>×</td> <td>×</td> </tr> <tr> <td>0</td> <td>1</td> <td>○</td> <td>×</td> <td>○</td> </tr> <tr> <td>1</td> <td>0</td> <td>○</td> <td>○</td> <td>×</td> </tr> <tr> <td>1</td> <td>1</td> <td>○</td> <td>×</td> <td>×</td> </tr> </tbody> </table>	T1	T0	CLOCK	TIMER	SNOOZE	0	0	×	×	×	0	1	○	×	○	1	0	○	○	×	1	1	○	×	×														
T1	T0	CLOCK	TIMER	SNOOZE																																				
0	0	×	×	×																																				
0	1	○	×	○																																				
1	0	○	○	×																																				
1	1	○	×	×																																				
Time format	<p>To select 12 hour format or 24 hour format.                      With diode jumper : 24 hour format.                      Without diode jumper : 12 hour format.</p>																																							
9k 10k	<p>Selects AM / FM step.                      Without the jumper : MW 10k / FM 100k step                      With the jumper : MW 9k / FM 50k step                      However, FM band for USA, Canada, Australia, and MW band for China is Fixed step.</p>																																							
BAND OUT	<p>With diode jumper :                      The band changeover of cyclical method can be carried out by [BAND] key.                      Without diode jumper :                      Selects receiving bands according to combination of the band input ports B0 and B1.</p>																																							

The diode jumper is read when a radio is turned on or there is key input.

**I/O PORT**

PORT	No.	NAME	I/O	FUNCTION	ACTIVE	INIT.																																			
P10	30	B0	IN	Without [band out] jumper <table border="1" style="margin: 5px;"> <thead> <tr> <th>B1</th> <th>B0</th> <th>USA Can.</th> <th>Gen. SW-A</th> <th>M. EAST China</th> <th>Europe</th> <th>Gen. SW-B</th> </tr> </thead> <tbody> <tr> <td>0</td> <td>0</td> <td>FM</td> <td>FM</td> <td>FM</td> <td>FM</td> <td>FM</td> </tr> <tr> <td>0</td> <td>1</td> <td>FM</td> <td>LW</td> <td>SW 1</td> <td>LW</td> <td>LW</td> </tr> <tr> <td>1</td> <td>0</td> <td>MW</td> <td>MW</td> <td>MW</td> <td>MW</td> <td>MW</td> </tr> <tr> <td>1</td> <td>1</td> <td>FM</td> <td>SW-A</td> <td>SW 2</td> <td>FM</td> <td>SW-B</td> </tr> </tbody> </table>	B1	B0	USA Can.	Gen. SW-A	M. EAST China	Europe	Gen. SW-B	0	0	FM	FM	FM	FM	FM	0	1	FM	LW	SW 1	LW	LW	1	0	MW	MW	MW	MW	MW	1	1	FM	SW-A	SW 2	FM	SW-B	—	—
					B1	B0	USA Can.	Gen. SW-A	M. EAST China	Europe	Gen. SW-B																														
0	0	FM	FM	FM	FM	FM																																			
0	1	FM	LW	SW 1	LW	LW																																			
1	0	MW	MW	MW	MW	MW																																			
1	1	FM	SW-A	SW 2	FM	SW-B																																			
P11	29	B1	IN		—	—																																			
P10	30	B0	OUT	With [band out] jumper <table border="1" style="margin: 5px;"> <thead> <tr> <th>B1</th> <th>B0</th> <th>USA Can.</th> <th>Gen. SW-A</th> <th>M. EAST China</th> <th>Europe</th> <th>Gen. SW-B</th> </tr> </thead> <tbody> <tr> <td>0</td> <td>0</td> <td>FM</td> <td>FM</td> <td>FM</td> <td>FM</td> <td>FM</td> </tr> <tr> <td>0</td> <td>1</td> <td>FM</td> <td>LW</td> <td>SW 1</td> <td>LW</td> <td>LW</td> </tr> <tr> <td>1</td> <td>0</td> <td>MW</td> <td>MW</td> <td>MW</td> <td>MW</td> <td>MW</td> </tr> <tr> <td>1</td> <td>1</td> <td>FM</td> <td>SW-A</td> <td>SW 2</td> <td>FM</td> <td>SW-B</td> </tr> </tbody> </table>	B1	B0	USA Can.	Gen. SW-A	M. EAST China	Europe	Gen. SW-B	0	0	FM	FM	FM	FM	FM	0	1	FM	LW	SW 1	LW	LW	1	0	MW	MW	MW	MW	MW	1	1	FM	SW-A	SW 2	FM	SW-B	—	L
					B1	B0	USA Can.	Gen. SW-A	M. EAST China	Europe	Gen. SW-B																														
0	0	FM	FM	FM	FM	FM																																			
0	1	FM	LW	SW 1	LW	LW																																			
1	0	MW	MW	MW	MW	MW																																			
1	1	FM	SW-A	SW 2	FM	SW-B																																			
P11	29	B1	OUT		—	L																																			
P12	28	TIMER OUT	OUT	This port is put at "H" level during the timer operation.	H	L																																			
P13	27	SLEEP OUT	OUT	This port is put at "H" level during the SLEEP period.	H	L																																			
MUTE	31	MUTE	OUT	Muting output	H	L																																			
$\overline{\text{INH}}$	35	$\overline{\text{INH}}$	IN	$\overline{\text{INH}} = \text{"H"}$ : radio function is active. $\overline{\text{INH}} = \text{"L"}$ : radio function is stop.	—	—																																			

**BAND SWITCHING**

1. Principal Function

Bands are switched.

2. Input Ports and Keys to be Used.

B0, B1 [BAND] key, [band out] diode switch

3. Function

When [band out] diode switch is OFF.

- a. Selects receiving bands according to combination of the band input ports B0 and B1.
- b. Bands selected according to destination are as follows :

INPUT PORT		U.S.A CANADA (2 BAND)	EUROPE (3 BAND)	M. EAST CHINA (4 BAND)	GENERAL (1) (4 BAND)	GENERAL (2) (4 BAND)
P11	P10					
0	0	FM	FM	FM	FM	FM
0	1	(FM)	LW	SW 1	LW	LW
1	0	AM	MW	MW	MW	MW
1	1	(FM)	(FM)	SW 2	SW-A	SW-B

When [band out] diode switch is ON.

- a. When [BAND OUT] jumper is valid, briefly press this button will alter the radio in a cyclic function.

Europe area



Middle EAST & China area

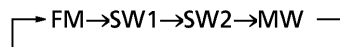

Other area

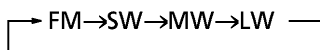

U.S.A & Canada area

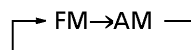



**MANUAL TUNING**

## 1. Principal Function

1 push / 1 step tuning by [UP] / [DOWN] key.

## 2. Input Ports and Keys to be Used.

[UP] key, [DOWN] key

## 3. Function

- a. 1 push / 1 step tuning by [UP] / [DOWN] key.
- b. Tuning is continuously carried out when [UP] / [DOWN] key is kept pushed continuously for more than 1 second.
- c. During the continuous tuning, any other key input is not accepted and even a broadcasting station is detected, it is not stopped.
- d. If the upper limit frequency is reached, it shifts toward the lower limit frequency and when the lower limit frequency is reached, it shifts toward the upper limit frequency.  
At this time, the system stops for 500ms as frequency.

**AUTO SEARCH TUNING**

1. Principal Function

Continuously pressing [UP]/[DOWN] key for 1 second, auto seek function will be activated.

2. Input Ports and Keys to be Used.

[UP] key, [DOWN] key

3. Function

- a. Continuously pressing [UP] key for 1 second, auto seek-up function will be activated. Similarly, continuously pressing [DOWN] key for 1 second, auto seek-down function will be activated.
- b. The auto tuning speed is the same as the continuous tuning speed. However, in the SW band, the inside of the meter band only is scanned at 5kHz per step.
- c. If STOP signal is detected by IF counter input, the tuning stops at that frequency.
- d. Meter band frequencies in SW band are as follows :

BAND	FREQUENCY	STEP
SW1	2.300 ~ 2.495	5kHz
	3.200 ~ 3.400	
	3.900 ~ 4.000	
	4.750 ~ 5.060	
	5.950 ~ 6.200	
SW2	7.100 ~ 7.300	5kHz
	9.500 ~ 9.900	
	11.650 ~ 12.050	
	13.600 ~ 13.800	
	15.100 ~ 15.600	
	17.550 ~ 17.900	
	21.450 ~ 21.850	

BAND	FREQUENCY	STEP
SW-A	5.950 ~ 6.200	5kHz
	7.100 ~ 7.300	
	9.500 ~ 9.900	
	11.650 ~ 12.050	
	13.600 ~ 13.800	
	15.100 ~ 15.600	

BAND	FREQUENCY	STEP
SW-B	3.900 ~ 4.000	5kHz
	4.750 ~ 5.060	
	5.950 ~ 6.200	
	7.100 ~ 7.300	
	9.500 ~ 9.900	
	11.650 ~ 12.050	

**PRESET MEMORY**

1. Principal Function

The number of preset memories set up by destination can be realized.

2. Input Ports and Keys to be Used.

[M1]~[M5] key Specification for Middle East and China

[M1]~[M5] key, [SHIFT] key (M6~M10) Specification for other zones

3. Function

- a. When [M1]~[M5] keys for the specifications for the Middle East and China are pushed, the pushed preset memories are read out.
- b. For the specification for other zones, when [M1]~[M10] keys are pushed, the pushed preset memories are read out. In this case, [M6]~[M10] keys become effective by pushing [M1]~[M5] keys after pushing [SHIFT] key.  
Pushing [SHIFT] key result in the shift mode but no indication is made, and the shift mode is released when [SHIFT] key is pushed again.
- c. When [MEMORY] key is pushed, "MEMORY" indication lights and during this period if the preset key is pushed, a frequency is written in that preset memory and lighting of "MEMORY" indication ends.  
"MEMORY" indication also goes out by any key input other than [SHIFT] key and the write status is canceled.
- d. Preset number is indicated on LCD but in case of CH 10, "0" is indicated.
- e. Destinations, receiving bands and number of preset memory channels are as follows :

DIODE			FM	MW	LW	SW			REMARK
E0	E1	E2				SW	SW 1	SW 2	
			10	10	—	—	—	—	USA 1
		○	10	10	—	—	—	—	USA 2
	○		10	5	5	5	—	—	Gen. SW-A
	○	○	10	5	5	—	—	—	Europe
○			5	5	—	—	5	5	M. EAST
○		○	10	5	5	5	—	—	Gen. SW-B
○	○		10	10	—	—	—	—	Canada
○	○	○	5	5	—	—	5	5	China

○ : with diode

**MEMORY SCAN**

## 1. Principal Function

All the preset memories are read out at intervals of 5 second.

## 2. Input Ports and Keys to be Used.

[MEMORY SCAN] key

## 3. Function

- a. Use by switching a mode to the frequency mode.
- b. When [MEMORY SCAN] key is pushed during the preset memory receiving, from next channel the preset memories are read out at intervals of 5 second. and when made a round, the memory scan stops at the channel where the preset memory was previously receiving before the memory scan.
- c. When the preset key of correction number is depressed during the memory scan, the memory scan is stopped at the receiving preset memory.
- d. Memory scan turns back M1 after M10. If there was no key input, the memory scan is automatically released after 1 cycle.
- e. In the following cases, memory scan is stopped.
  - When any key other than [MEMORY SCAN] key is operated.
  - When a band is being switched.
- f. During the memory scan, the preset channel number segments flash at 1Hz.
- g. If [MEMORY SCAN] key is pushed during the memory scan, the preset memory currently being indicated is skipped to next preset memory and the memory scan is continued.

**CLOCK FUNCTION**

## 1. Principal Function

Corrects a current time.

## 2. Input Ports and Keys to be Used.

[UP] key, [DOWN] key, [MEMORY] key, [MODE] key

## 3. Function

- a. Sets the clock indication with the [MODE] key.
- b. Push the [C-adj] key, the same key as the [MEMO] key. Press the [HOUR] ([MIN]) key in combination with the [C-adj] key to advance the hour (minute) digit.
- c. After timer correction is completed, press the [MODE] key repeatedly until the desired display mode is shown.
- d. When correcting "MIN.", second. is cleared to "00" if any key input is made.

**SLEEP TIMER**

1. Principal Function  
The 90 min. sleep timer can be set.
2. Input Ports and Keys to be Used.  
[SLEEP] key
3. Function
  - a. When [SLEEP] key is pushed, the sleep out (P13) is put at "H" level, 'SLEEP' and a sleep time are indicated on LCD, and a 90 min. sleep time is set up. Further, if [SLEEP] key is pushed again, the sleep operation is released and the sleep out (P13) is put at "L" level.
  - b. To change a sleep time, directly push [SLEEP] key continuously for more than 1 second. when setting the sleep operation. A sleep time can be set up at intervals of 0.5 second./step like 90, 80, ... 10, 1, 90.
  - c. There is no indication for residual sleep time and if there is not [SLEEP] key input for 5 second., the system returns to a mode before pushing [SLEEP] key.

**TIMER FUNCTION**

1. Principal Function  
Setting of the timer ON/OFF time and timer optation. (only SNOOZE disable mode)
2. Input Ports and Keys to be Used.  
[TIMER] key, [MODE] key, [HOUR] (DOWN) key, [MIN] (UP) key, [MEMO] key
3. Function
  - a. [MODE] key optations among frequency, clock and timer mode cyclically. The timer correction function is automatically released after 10 second. if no key input. Then, a current time is indicated.

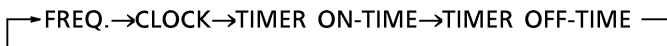

To check the ON-TIME (OFF-TIME) of the timer.

To push the [MODE] key repeatedly until the ON-TIME (OFF-TIME) is displayed.

To correct the ON-TIME (OFF-TIME) of the timer.

1. Push the [MODE] key repeatedly until the ON-TIME (OFF-TIME) is displayed.
  2. Push the [MEMO] key, the same key as the [MEMO] key, the ON-TIME (OFF-TIME) indicator on the display will be flicker. Press the [HOUR] ([MIN]) key in combination with the [MEMO] key to advance the hour (minute) digit.
  3. After timer correction is completed, press the [MODE] key repeatedly until the disired display mode is shown.
- b. [TIMER] key operations between TIMER-STANDBY and TIMER-OFF mode cyclically.

### SNOOZE FUNCTION

#### 1. Principal Function

Setting of the timer ON time and SNOOZE operation.

#### 2. Input Ports and Keys to be Used.

[SNOOZE] key

#### 3. Function

- a. When [T0] diode jumper ON and [T1] diode jumper OFF, timer function change to snooze function. [MODE] key operations among frequency, clock and timer mode cyclically. The time correction function is automatically released after 10 second. if no key input. Then, a current time is indicated.

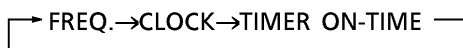

- b. At the TIMER ON-TIME, timer-out (P12) changes from "L" to "H".
- c. If [SNOOZE] key pushed on the TIMER-ON state, timer-out (P12) changes from "H" to "L". After 5 minutes, timer-out (P12) changes from "L" to "H" again. This function is available within 2 hours time.

### MUTE

#### 1. Principal Function

In the following cases, mute signal (H active) is output.

#### 2. Input Ports and Keys to be Used.

Mute port (pin 31)

#### 3. Function

- a. In the following cases, mute signal is output for 1 second. :
- When initializing
  - When switching a receiving band
  - When calling a preset channel
  - When turning a radio OFF or ON (Radio ON/OFF by the  $\overline{\text{INH}}$ )
  - When memory scanning
- b. In the following cases, mute signal is output :
- During auto up tuning
  - When reaching the band edge during manual up/down tuning or continuous tuning
- c. In the following cases, no mute signal is output :
- In the clock mode
  - When operating [MEMORY], [MODE] or [SHIFT] key
  - When writing into a preset channel
  - When calling the same preset channel

Mute output timing and PLL data

PLL : PLL data set timing

IF : IF count start timing

1. When initializing

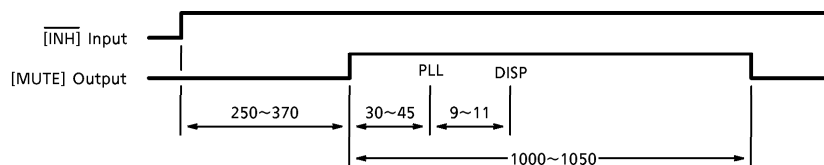

UNIT : ms

2. When a radio ON/OFF  
Radio OFF to ON

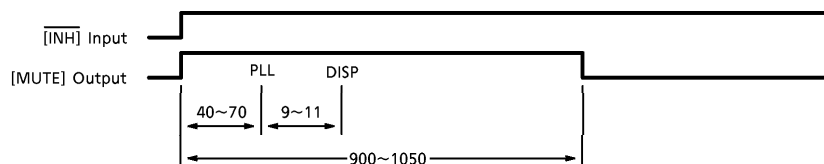

UNIT : ms

Radio ON to OFF

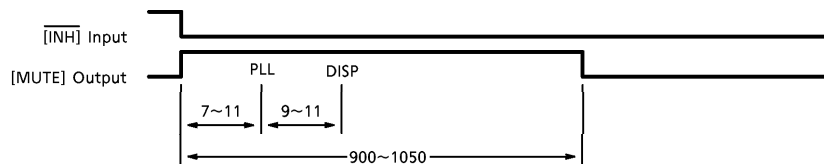

UNIT : ms

3. Band change (by slide switch)



UNIT : ms

4. Band change (by push switch)

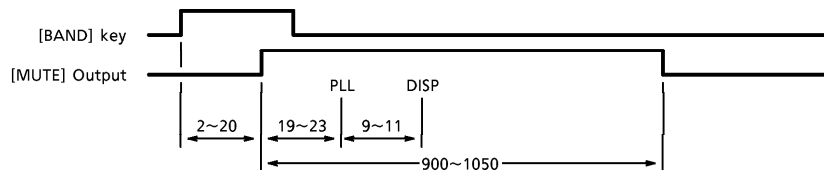

UNIT : ms

5. When calling a preset memory

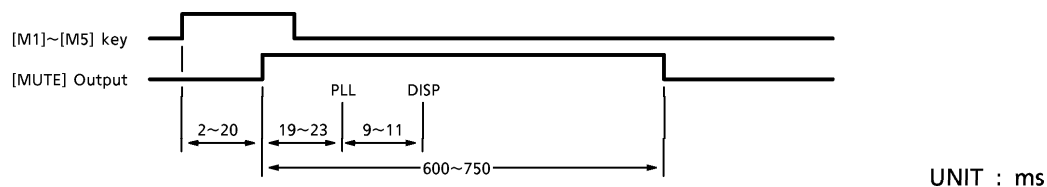

6. Auto seek tuning

narrow : count gate time at narrow accuracy = 4ms (AM) / 1ms (FM)  
 Wide : count gate time at wide accuracy = 16ms (AM) / 4ms (FM)

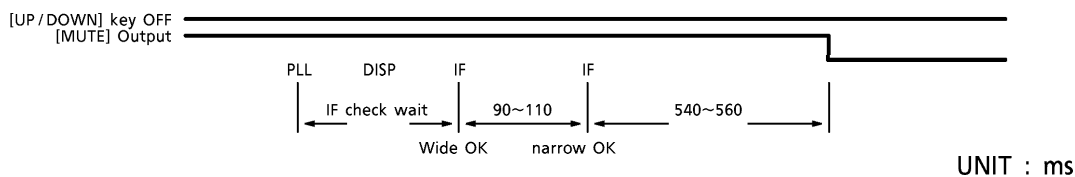
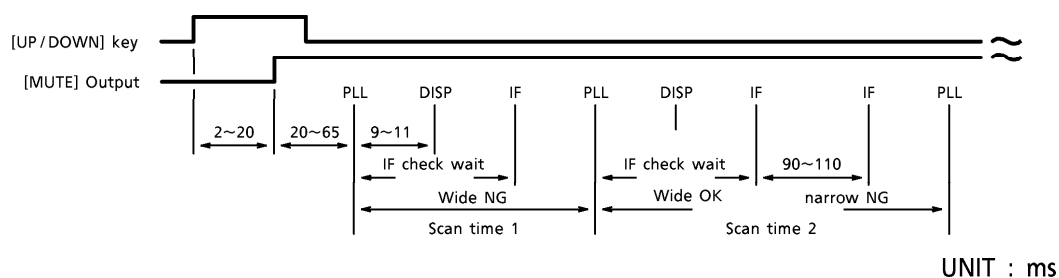

BAND	SCAN TIME 1 [ms]	SCAN TIME 2 [ms]	IF CHECK WAIT [ms]
FM	95~110	190~205	65~85
AM	190~210	285~305	155~175

Note : Time of SCAN TIME 1 is about 0.5 second. wait time when changing from upper limit frequency to lower limit frequency and about 1 second. when changing into SW meter band.