

SECONDARY CHOPPER REGULATOR FOR VTR

(セカンダリーチョッパーレギュレータ)

Family シリーズ名	Constitution 構成	Maximum Rating 最大定格			Type No 機種	Output1			Output2			Frequency 周波数	Equiva- lent 等価 回路	Appli- cation 応用 回路	Pack age 外形 図				
		Vin(DC)	Tc max	Tstg		Vo	Io		Vo	Io									
							Av	Pk		Av	Pk								
		max V	°C	°C		V	A	A	V	A	A								
STK 7210	Chopper+Series (Out2) (Out1)	50	+105	-30	STK7216S	9.0	1.0	1.0	12.0	3.5	3.5	54	(1)	(1)	(1)				
					STK7217	9.0	1.5	1.5	12.0	5.0	5.0					54	(1)	(1)	(1)
					STK7221	12.0	1.5	1.0	13.6	4.0	3.5								
STK 7230	Chopper+Series (Out2) (Out1)	35	+105	+105	STK7231	12.0	1.5	1.0	13.6	2.0	3.5	83	(2)	(3)	(2)				
STK 7240	Chopper+Series (Out2) (Out1)	15	+105		STK7241	5.6	0.05	—	6.6	1.5	3.0	83	(3)	(4)	(2)				

FEATURES

- Hi-activated output cutoff function(Chopper side)
- Independent over current protection(Chopper side)
- Fixed oscillation type

特長

- チョッパー側はカットオフ機能付 (Hi-ON)/7210S
- チョッパー側は過電流保護機能内蔵
- 他励発振方式

EQUIVALENT CIRCUIT

(1)

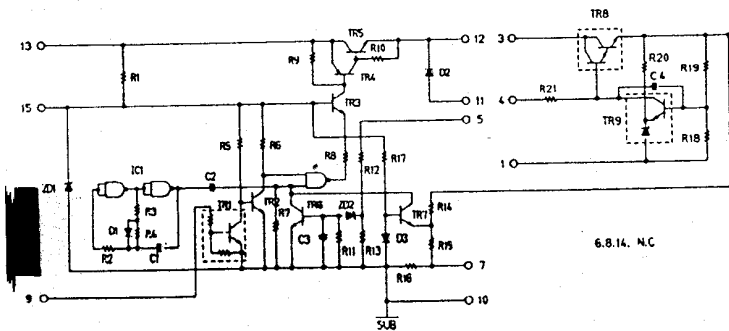

(2)

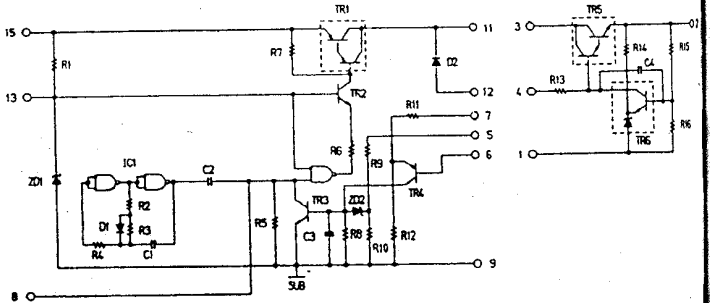

(3)

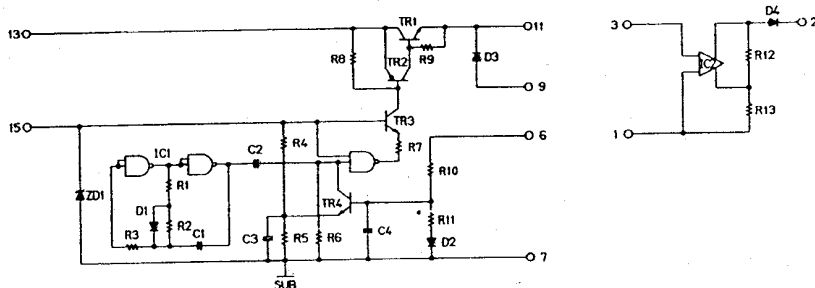

SECONDARY CHOPPER REGULATOR FOR VTR

■ APPLICATION

(1)

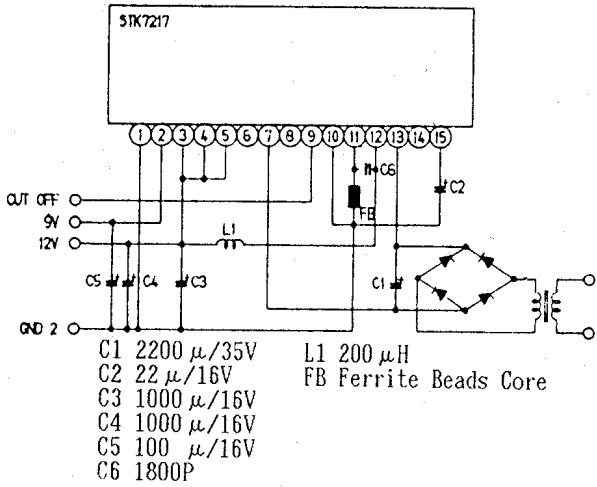

(2)

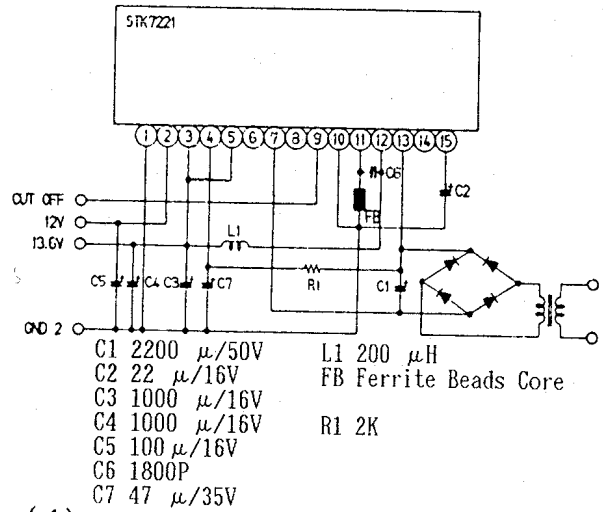

(3)

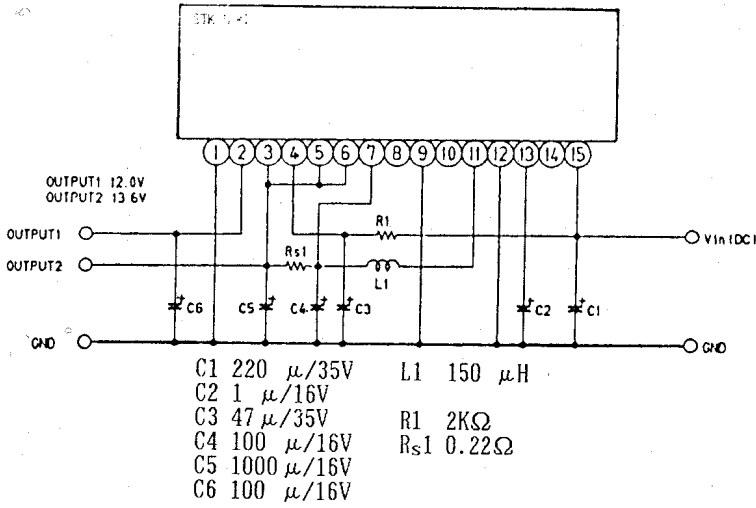

(4)

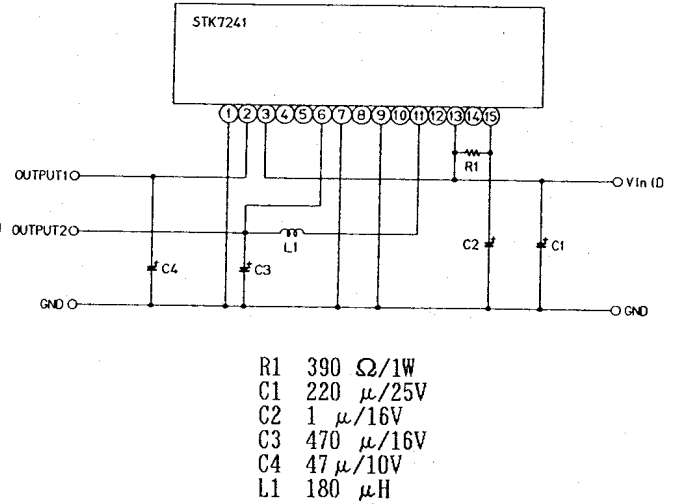

■ PACKAGE DIMENSION

(1)

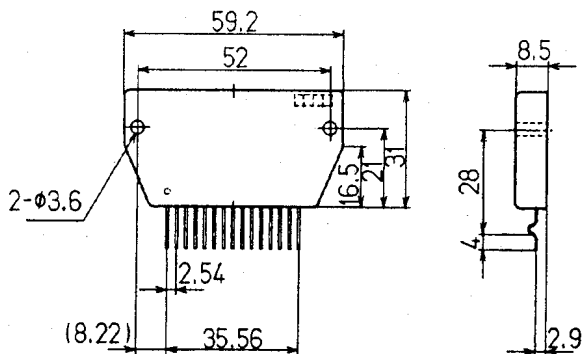

(2)

