



TISP3070T3BJ THRU TISP3395T3BJ

DUAL BIDIRECTIONAL THYRISTOR OVERVOLTAGE PROTECTORS

TISP3xxxT3BJ Overvoltage Protector Series

Dual High Current Protectors in a Space Efficient Package

- 2 x 100 A 10/560 Current Rating
- Modified 3-pin SMB (DO-214AA) Package
50 % Space Saving over Two SMBs
- Y Configurations with Two SMB Packages
2 x 80 A, 10/1000 . . . TISP3xxxT3BJ + TISP4xxxJ1BJ
2 x 100 A, 10/700 . . . TISP3xxxT3BJ + TISP4xxxH3BJ

Ion-Implanted Breakdown Region

- Precise and Stable Voltage
- Low Voltage Overshoot under Surge

Device	V _{DRM} V	V _(BO) V
TISP3070T3	58	70
TISP3080T3	65	80
TISP3095T3	75	95
TISP3115T3	90	115
TISP3125T3	100	125
TISP3145T3	120	145
TISP3165T3	135	165
TISP3180T3	145	180
TISP3200T3	155	200
TISP3219T3	180	219
TISP3250T3	190	250
TISP3290T3	220	290
TISP3350T3	275	350
TISP3395T3	320	395



SMB Package (Top View)

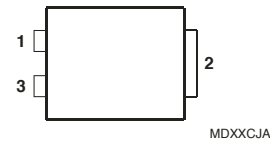

Device Symbol

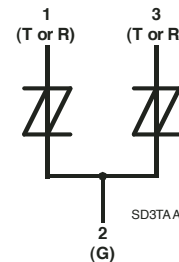

Rated for International Surge Wave Shapes

Wave Shape	Standard	I _{PPSM} A
2/10	GR-1089-CORE	250
8/20	IEC 61000-4-5	250
10/160	TIA/EIA-IS-968 (FCC Part 68)	150
10/700	ITU-T K.20/.21/.45	120
10/560	TIA/EIA-IS-968 (FCC Part 68)	100
10/1000	GR-1089-CORE	80

Description

These dual bidirectional thyristor devices protect central office, access and customer premise equipment against overvoltages on the telecom line. The TISP3xxxT3BJ is available in a wide range of voltages and has an 80 A 10/1000 current rating. These protectors have been specified mindful of the following standards and recommendations: GR-1089-CORE, TIA/EIA-IS-968, UL 60950, EN 60950, IEC 60950, ITU-T K.20, K.21 and K.45. The TISP3350T3BJ meets the FCC Part 68 "B" ringer voltage requirement (V_{DRM} = ±275 V). Housed in a 3-pin modified SMB (DO-214AA) package, the TISP3xxxT3BJ range is space efficient solution for protection designs of 80 A or less which use multiple SMBs.

These devices allow signal voltages, without clipping, up to the maximum off-state voltage value, V_{DRM}, see Figure 1. Voltages above V_{DRM} are limited and will not exceed the breakover voltage, V_(BO), level. If sufficient current flows due to the overvoltage, the device switches into a low-voltage on-state condition, which diverts the current from the overvoltage through the device. When the diverted current falls below the holding current, I_H, level the device switches off and restores normal system operation.

How To Order

Device	Package	Carrier	For Standard Termination Finish Order As	For Lead Free Termination Finish Order As
TISP3xxxT3BJ	BJ (3-pin modified SMB/DO-214AA J-Bend)	R (Embossed Tape Reeled)	TISP3xxxT3BJR	TISP3xxxT3BJR-S

Insert xxx value corresponding to protection voltages of 070, 080, 095, 115, etc.

*RoHS Directive 2002/95/EC Jan 27 2003 including Annex SEPTEMBER 2001 - REVISED FEBRUARY 2005
Specifications are subject to change without notice.
Customers should verify actual device performance in their specific applications.

TISP3xxxT3BJ Overvoltage Protector Series

BOURNS®

Absolute Maximum Ratings, $T_A = 25\text{ °C}$ (Unless Otherwise Noted)

Rating	Symbol	Value	Unit	
Repetitive peak off-state voltage, (terminals 1-2 and 3-2)	'3070	±58	V	
	'3080	±65		
	'3095	±75		
	'3115	±90		
	'3125	±100		
	'3145	±120		
	'3165	±135		
	'3180	±145		
	'3200	±155		
	'3219	±180		
	'3250	±190		
	'3290	±220		
	'3350	±275		
'3395	±320			
Non-repetitive peak on-state pulse current (see Notes 1 and 2)	I_{PPSM}	A	2/10 (Telcordia GR-1089-CORE, 2/10 voltage wave shape)	2x250
8/20 (IEC 61000-4-5, combination wave generator, 1.2/50 voltage wave shape)			2x250	
10/160 (TIA/EIA-IS-968 (replaces FCC Part 68), 10/160 μ s voltage wave shape)			2x150	
5/310 (ITU-T K.44, 10/700 μ s voltage wave shape used in K.20/.45/.21)			2x120	
5/320 (TIA/EIA-IS-968 (replaces FCC Part 68), 9/720 μ s voltage wave shape)			2x120	
10/560 (TIA/EIA-IS-968 (replaces FCC Part 68), 10/560 μ s voltage wave shape)			2x100	
10/1000 (Telcordia GR-1089-CORE, 10/1000 voltage wave shape)			2x80	
Non-repetitive peak on-state current (see Notes 1 and 2)	I_{TSM}	A	50 Hz, 1 cycle	2x25
60 Hz, 1 cycle			2x30	
1000 s 50 Hz/60 Hz a.c.			2x1.2	
Initial rate of rise of on-state current, Linear current ramp, Maximum ramp value < 50 A	di_T/dt	500	A/ μ s	
Junction temperature	T_J	-40 to +150	°C	
Storage temperature range	T_{stg}	-65 to +150	°C	

NOTES: 1. Initially, the device must be in thermal equilibrium with $T_J = 25\text{ °C}$.

2. These non-repetitive rated currents are peak values of either polarity. The rated current values are applied to the terminals 1 and 3 simultaneously (in this case the terminal 2 return current will be the sum of the currents applied to the terminals 1 and 3). The surge may be repeated after the device returns to its initial conditions.

Recommended Operating Conditions

Component	Min	Typ	Max	Unit
Series resistor for GR-1089-CORE first-level surge survival	5			Ω
Series resistor for ITU-T recommendation K.20/.45/.21 (coordination with 400 V GDT at 4 kV)	6.4			
R1, R2 Series resistor for TIA/EIA-IS-968 (replaces FCC Part 68) 9/720 survival	0			
Series resistor for TIA/EIA-IS-968 (replaces FCC Part 68) 10/560 survival	0			
Series resistor for TIA/EIA-IS-968 (replaces FCC Part 68) 10/160 survival	2.5			

SEPTEMBER 2001 - REVISED FEBRUARY 2005

Specifications are subject to change without notice.

Customers should verify actual device performance in their specific applications.

TISP3xxxT3BJ Overvoltage Protector Series

BOURNS®

Electrical Characteristics for the 1 and 2 or the 3 and 2 Terminals, $T_A = 25\text{ }^\circ\text{C}$

Parameter	Test Conditions	Min	Typ	Max	Unit
I_{DRM} Repetitive peak off-state current	$V_D = V_{\text{DRM}}$ $T_A = 25\text{ }^\circ\text{C}$ $T_A = 85\text{ }^\circ\text{C}$			± 5 ± 10	μA
$V_{(\text{BO})}$ AC breakover voltage	$dv/dt = \pm 250\text{ V/ms}$, $R_{\text{SOURCE}} = 300\ \Omega$			'3070 '3080 '3095 '3115 '3125 '3145 '3165 '3180 '3200 '3219 '3250 '3290 '3350 '3395	V
$V_{(\text{BO})}$ Ramp breakover voltage	$dv/dt \leq \pm 1000\text{ V}/\mu\text{s}$, Linear voltage ramp, Maximum ramp value = $\pm 500\text{ V}$ $di/dt = \pm 20\text{ A}/\mu\text{s}$, Linear current ramp, Maximum ramp value = $\pm 10\text{ A}$			'3070 '3080 '3095 '3115 '3125 '3145 '3165 '3180 '3200 '3219 '3250 '3290 '3350 '3395	V
$I_{(\text{BO})}$ Breakover current	$dv/dt = \pm 250\text{ V/ms}$, $R_{\text{SOURCE}} = 300\ \Omega$			± 800	mA
I_H Holding current	$I_T = \pm 5\text{ A}$, $di/dt = +/ -30\text{ mA/ms}$	± 150			mA
dv/dt Critical rate of rise of off-state voltage	Linear voltage ramp, Maximum ramp value $< 0.85V_{\text{DRM}}$	± 5			kV/ μs
I_D Off-state current	$V_D = \pm 50\text{ V}$ $T_A = 85\text{ }^\circ\text{C}$			± 10	μA

SEPTEMBER 2001 - REVISED FEBRUARY 2005
 Specifications are subject to change without notice.
 Customers should verify actual device performance in their specific applications.

TISP3xxxT3BJ Overvoltage Protector Series

BOURNS®

Electrical Characteristics for the 1 and 2 or the 3 and 2 Terminals, $T_A = 25\text{ }^\circ\text{C}$ (Continued)

Parameter	Test Conditions	Min	Typ	Max	Unit
C_{off} Off-state capacitance	$f = 1\text{ MHz}, V_d = 1\text{ V rms}, V_D = 0,$	'3070 thru '3095	95	114	pF
		'3115 thru '3219	69	83	
		'3250 thru '3395	51	62	
	$f = 1\text{ MHz}, V_d = 1\text{ V rms}, V_D = -1\text{ V}$	'3070 thru '3095	90	108	
		'3115 thru '3219	63	76	
		'3250 thru '3395	46	55	
	$f = 1\text{ MHz}, V_d = 1\text{ V rms}, V_D = -2\text{ V}$	'3070 thru '3095	83	100	
		'3115 thru '3219	59	70	
		'3250 thru '3395	42	51	
	$f = 1\text{ MHz}, V_d = 1\text{ V rms}, V_D = -50\text{ V}$	'3070 thru '3095	43	51	
		'3115 thru '3219	29	35	
		'3250 thru '3395	20	24	
$f = 1\text{ MHz}, V_d = 1\text{ V rms}, V_D = -100\text{ V}$ (see Note 3)	'3250 thru '3395	16	19		

NOTE 3: These capacitance measurements employ a three terminal capacitance bridge incorporating a guard circuit. The unmeasured third terminal is connected to the guard terminal of the bridge.

Thermal Characteristics

Parameter	Test Conditions	Min	Typ	Max	Unit
$R_{\theta JA}$ Junction to free air thermal resistance	EIA/JESD51-3 PCB, $I_T = I_{TSM(1000)},$ $T_A = 25\text{ }^\circ\text{C},$ (see Note 4)			90	$^\circ\text{C/W}$

NOTE 4: EIA/JESD51-2 environment and PCB has standard footprint dimensions connected with 5 A rated printed wiring track widths.

SEPTEMBER 2001 - REVISED FEBRUARY 2005

Specifications are subject to change without notice.

Customers should verify actual device performance in their specific applications.

Parameter Measurement Information

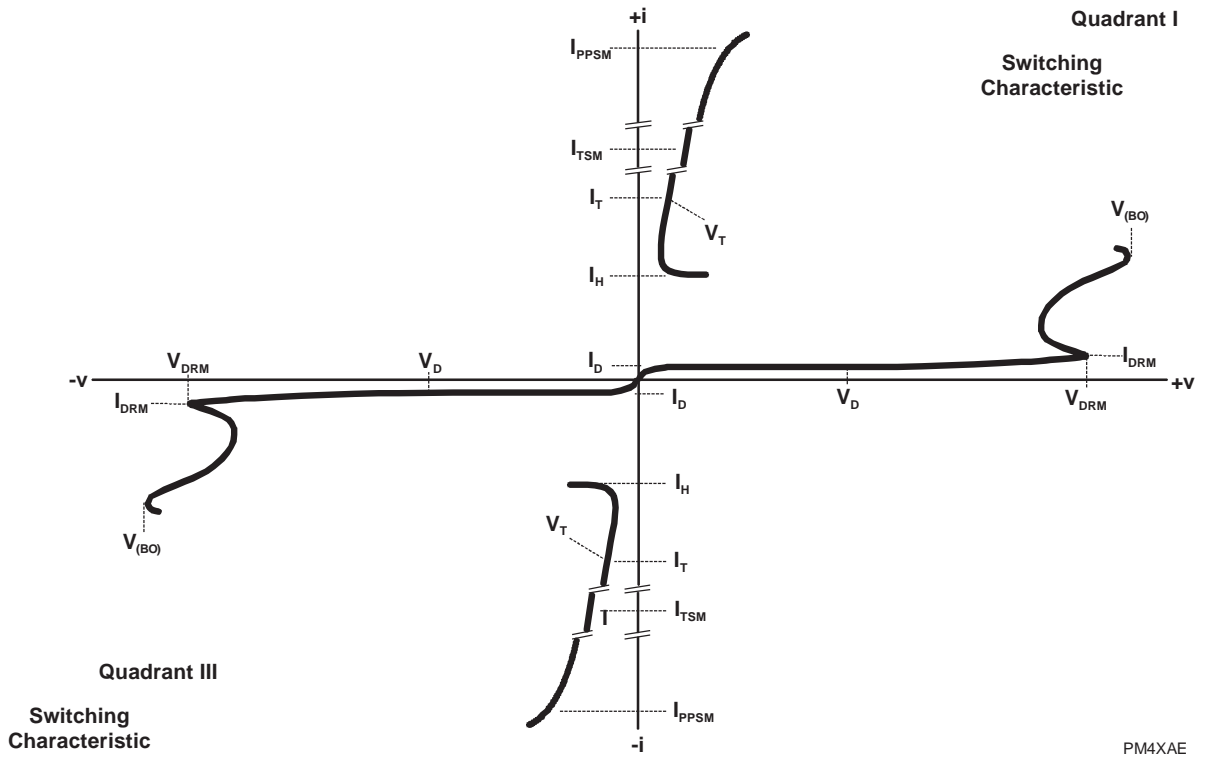

Figure 1. Voltage-Current Characteristic for Terminal Pairs 1-2 and 3-2
All Measurements are Referenced to Terminal 2

PM4XAE

Typical Characteristics

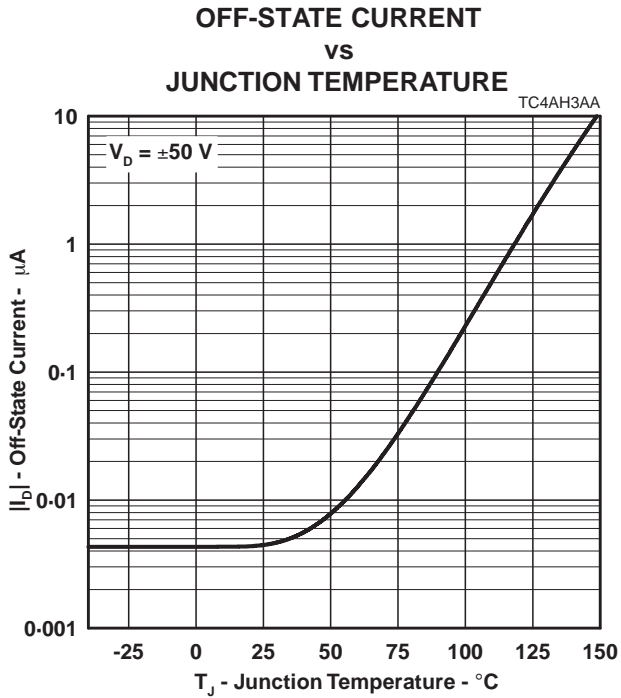

Figure 2.

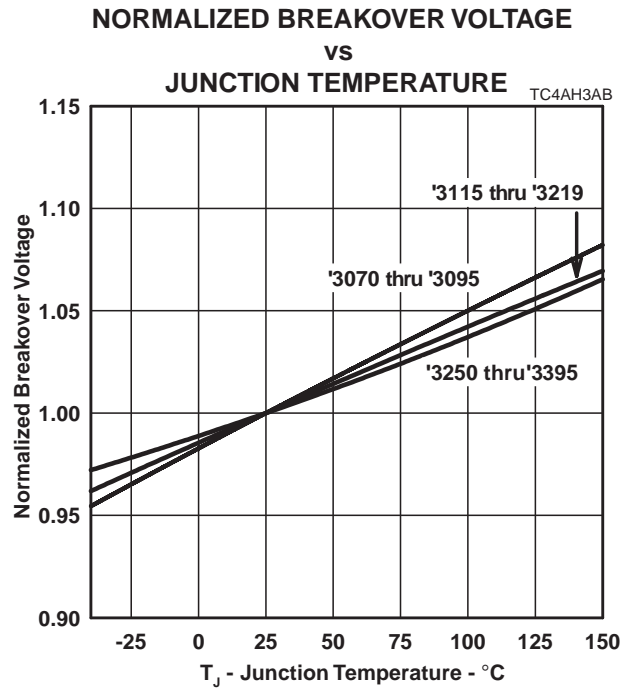

Figure 3.

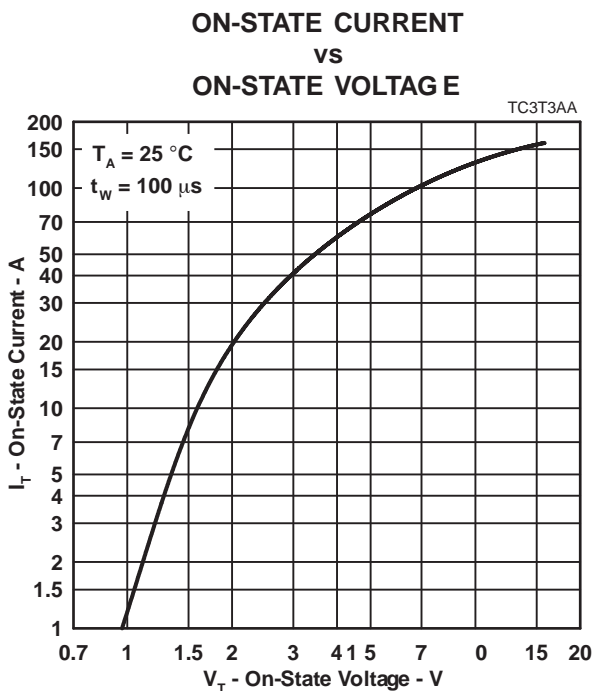

Figure 4.

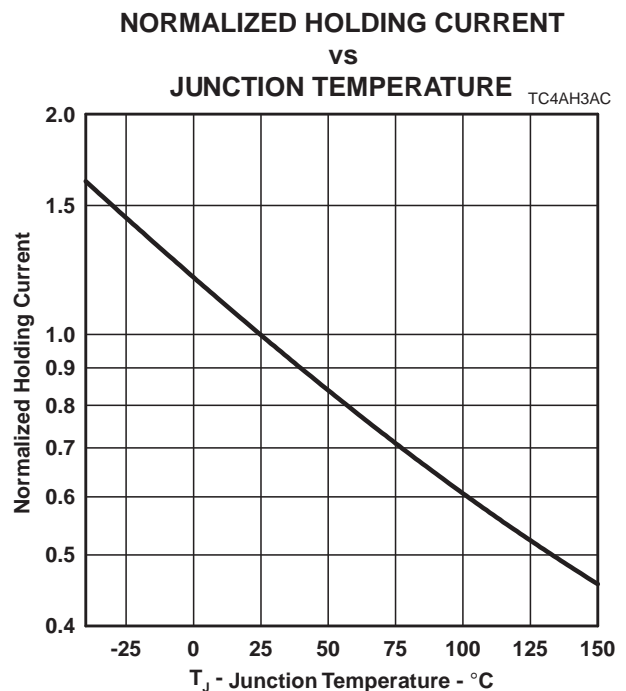
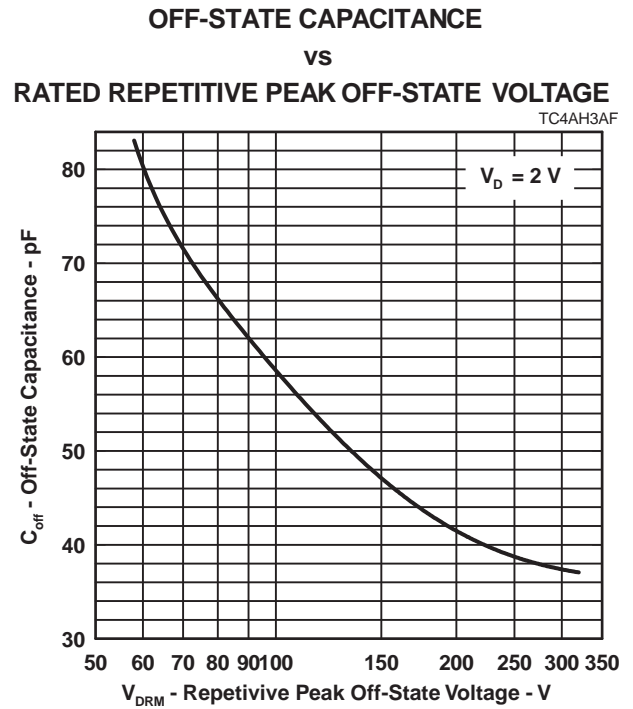
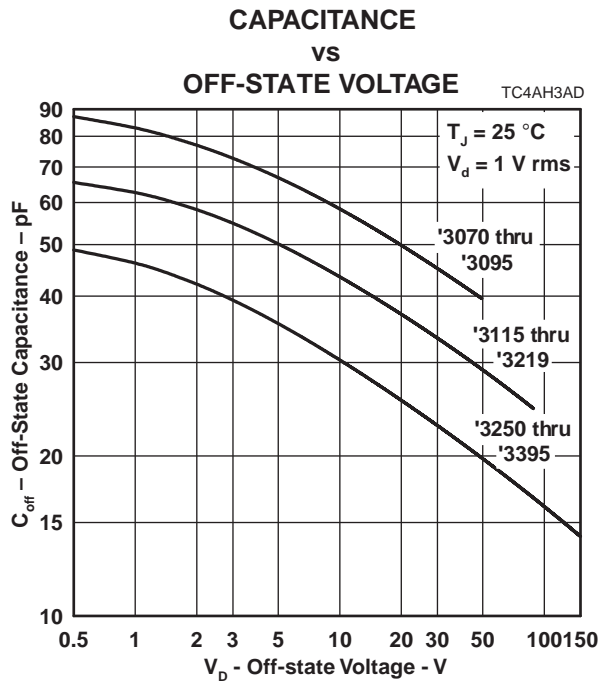

Figure 5.

Typical Characteristics



Rating and Thermal Information

**NON-REPETITIVE PEAK ON-STATE CURRENT
VS
CURRENT DURATION**

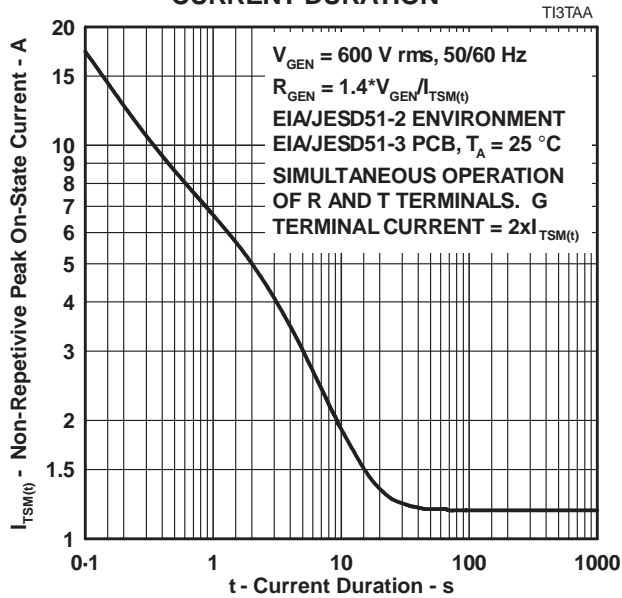

Figure 8.

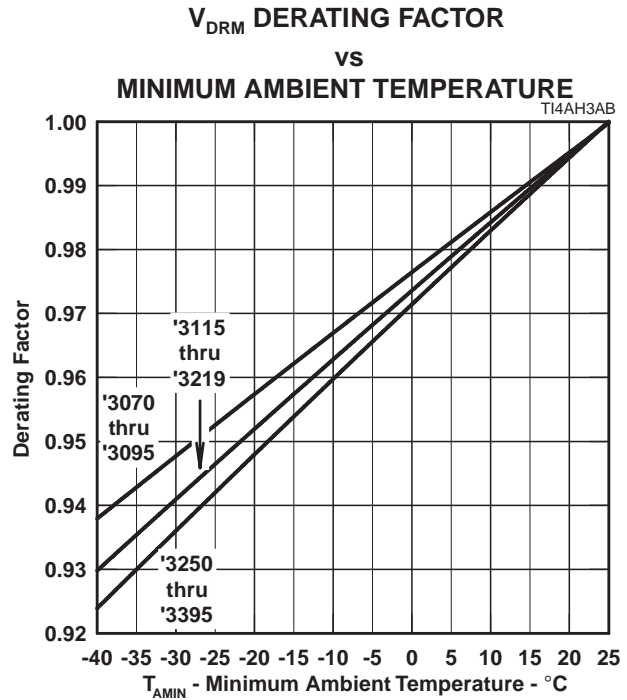

Figure 9.

TISP3xxxT3BJ Overvoltage Protector Series

BOURNS®

MECHANICAL DATA

Recommended Printed Wiring Land Pattern Dimensions

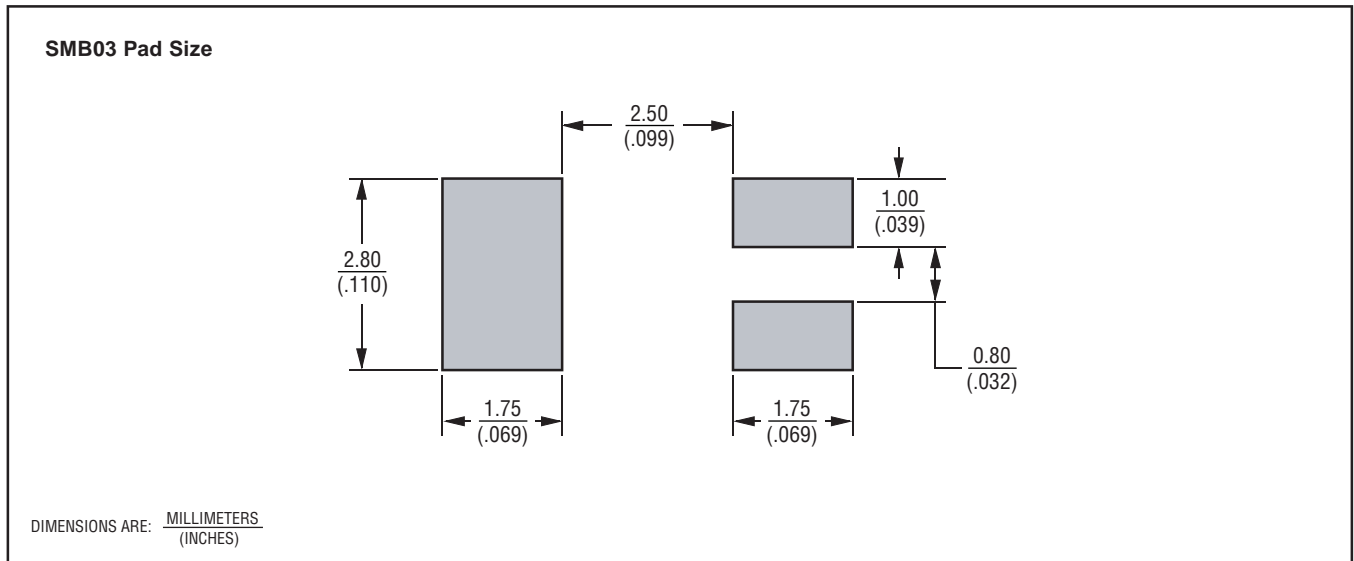

MD3BJAAA

Device Symbolization Code

Devices will be coded as below.

Device	Symbolization Code
TISP3070T3	3070T3
TISP3080T3	3080T3
TISP3095T3	3095T3
TISP3115T3	3115T3
TISP3125T3	3125T3
TISP3145T3	3145T3
TISP3165T3	3165T3
TISP3180T3	3180T3
TISP3200T3	3200T3
TISP3219T3	3219T3
TISP3250T3	3250T3
TISP3290T3	3290T3
TISP3350T3	3350T3
TISP3395T3	3395T3

Carrier Information

For production quantities, the carrier will be embossed tape reel pack. Evaluation quantities may be shipped in bulk pack or embossed tape.

Package	Carrier	Standard Quantity
SMB	Embossed Tape Reel Pack	3000

SEPTEMBER 2001 - REVISED FEBRUARY 2005
 Specifications are subject to change without notice.
 Customers should verify actual device performance in their specific applications.

TISP3xxxT3BJ Overvoltage Protector Series

BOURNS®

MECHANICAL DATA

Modified SMB (DO-214AA) Plastic Surface Mount Triode Package

This surface mount package consists of a circuit mounted on a lead frame and encapsulated within a plastic compound. The compound will withstand soldering temperature with no deformation, and circuit performance characteristics will remain stable when operated in high humidity conditions. Leads require no additional cleaning or processing when used in soldered assembly.

SMB03

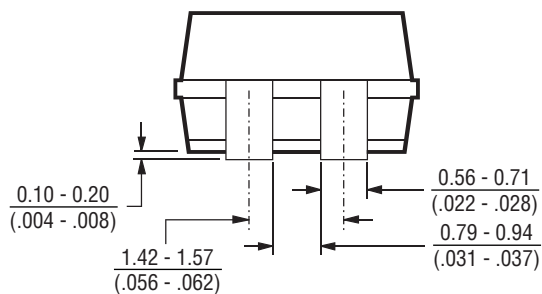
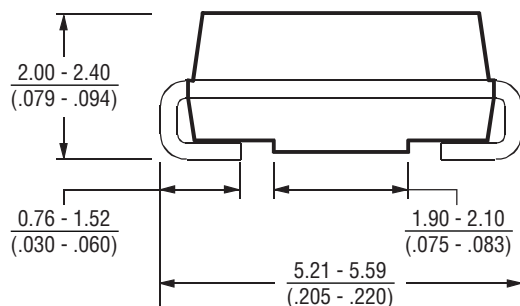
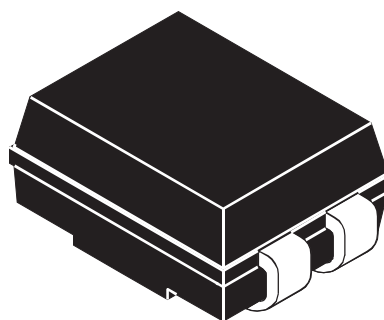
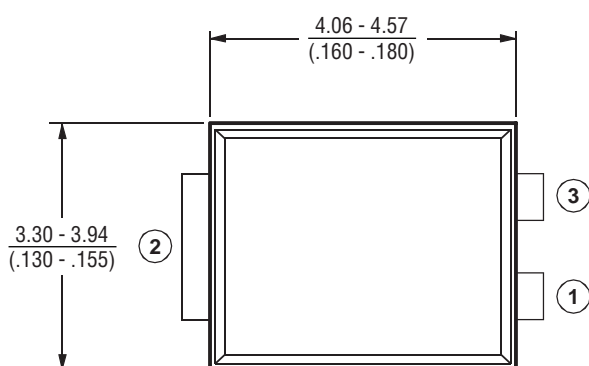

DIMENSIONS ARE: MILLIMETERS
(INCHES)

MDXXCIA

SEPTEMBER 2001 - REVISED FEBRUARY 2005
Specifications are subject to change without notice.

Customers should verify actual device performance in their specific applications.

TISP3xxxT3BJ Overvoltage Protector Series

BOURNS®

MECHANICAL DATA

Tape Dimensions

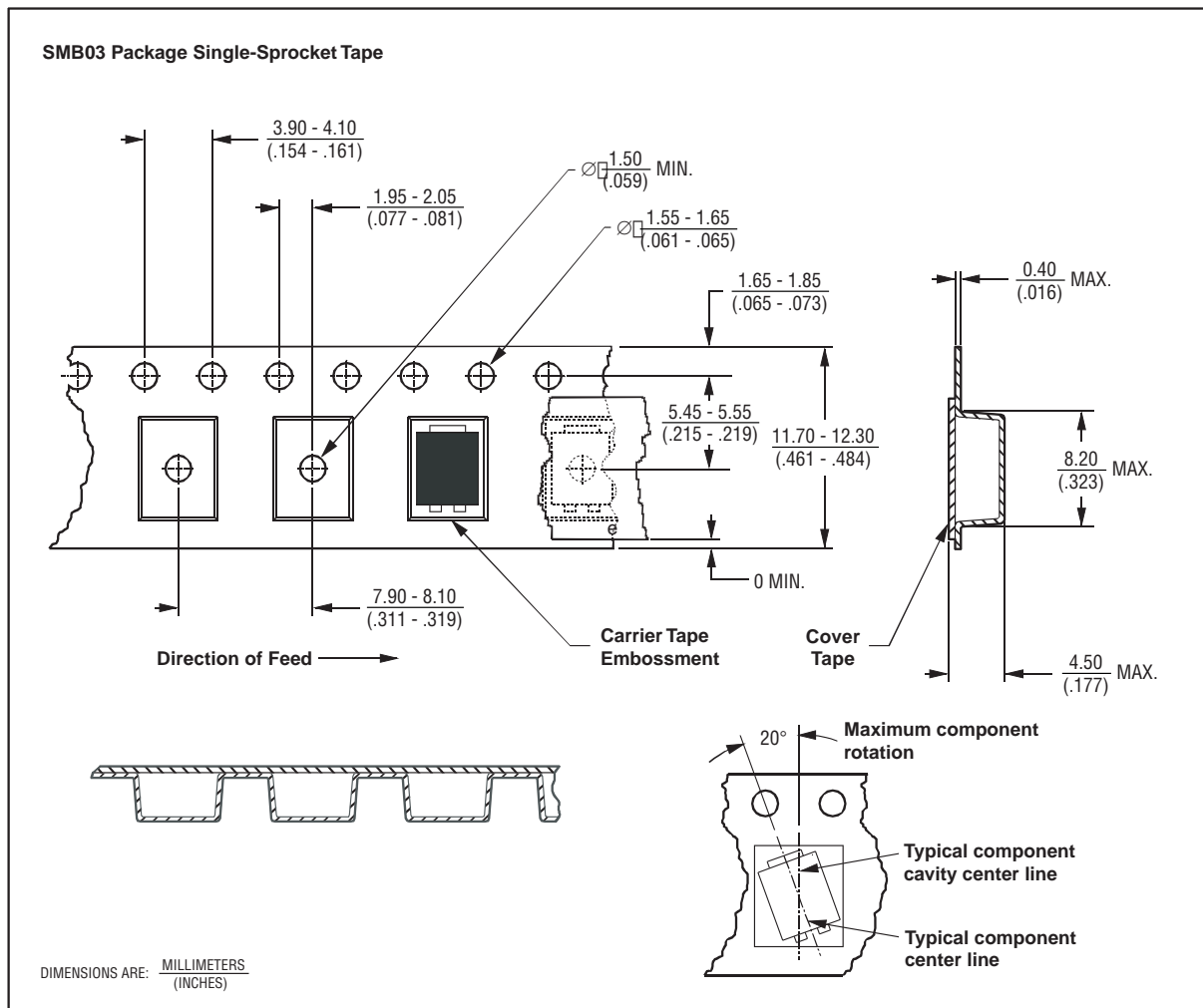

NOTES: A. The clearance between the component and the cavity must be within 0.05 mm (.002 in) MIN. to 0.65 mm (.026 in) MAX. so that the component cannot rotate more than 20° within the determined cavity.

MD3BJAB

B. Taped devices are supplied on a reel of the following dimensions:-

Reel diameter: 330 mm \pm 3.0 mm (12.99 in \pm .118 in)
 Reel hub diameter: 75 mm (2.95 in) MIN.
 Reel axial hole: 13.0 mm \pm 0.5 mm (.512 in \pm .020 in)

C. 3000 devices are on a reel.

"TISP" is a trademark of Bourns, Ltd., a Bourns Company, and is Registered in U.S. Patent and Trademark Office.

"Bourns" is a registered trademark of Bourns, Inc. in the U.S. and other countries.

SEPTEMBER 2001 - REVISED FEBRUARY 2005

Specifications are subject to change without notice.

Customers should verify actual device performance in their specific applications.