

**Features**

- Complementary Pair
- One 4401-Type NPN,  
One 4403-Type PNP
- Epitaxial Planar Die Construction
- Ideal for Low Power Amplification and Switching
- Ultra-Small Surface Mount Package
- **Lead Free/RoHS Compliant (Note 3)**

**Mechanical Data**

- Case: SOT-363
- Case Material: Molded Plastic. UL Flammability Rating 94V-0
- Moisture Sensitivity: Level 1 per J-STD-020C
- Terminals: Solderable per MIL-STD-202, Method 208
- Lead Free Plating (Matte Tin Finish annealed over Alloy 42 leadframe).
- Terminal Connections: See Diagram
- Marking Information: See Page 5
- Ordering & Date Code Information: See Page 5
- Weight: 0.006 grams (approximate)

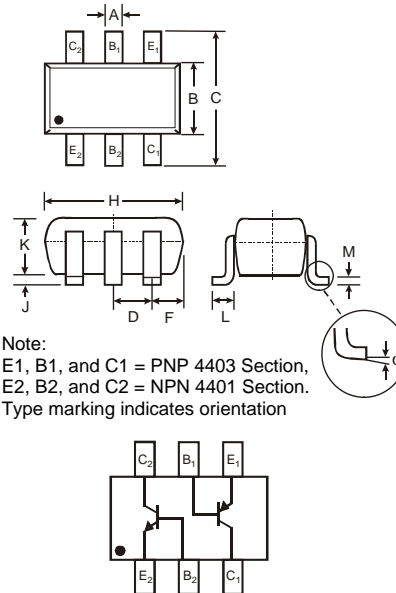

SOT-363		
Dim	Min	Max
A	0.10	0.30
B	1.15	1.35
C	2.00	2.20
D	0.65 Nominal	
F	0.30	0.40
H	1.80	2.20
J	—	0.10
K	0.90	1.00
L	0.25	0.40
M	0.10	0.25
$\alpha$	0°	8°
All Dimensions in mm		

**Maximum Ratings, Total Device** @T<sub>A</sub> = 25°C unless otherwise specified

Characteristic	Symbol	Value	Unit
Power Dissipation (Note 1, 2)	P <sub>d</sub>	200	mW
Thermal Resistance, Junction to Ambient (Note 1)	R <sub>θJA</sub>	625	°C/W
Operating and Storage and Temperature Range	T <sub>j</sub> , T <sub>STG</sub>	-55 to +150	°C

**Maximum Ratings, NPN 4401 Section** @T<sub>A</sub> = 25°C unless otherwise specified

Characteristic	Symbol	NPN4401	Unit
Collector-Base Voltage	V <sub>CBO</sub>	60	V
Collector-Emitter Voltage	V <sub>CEO</sub>	40	V
Emitter-Base Voltage	V <sub>EBO</sub>	6.0	V
Collector Current - Continuous (Note 1)	I <sub>C</sub>	600	mA

**Maximum Ratings, PNP 4403 Section** @T<sub>A</sub> = 25°C unless otherwise specified

Characteristic	Symbol	PNP4403	Unit
Collector-Base Voltage	V <sub>CBO</sub>	-40	V
Collector-Emitter Voltage	V <sub>CEO</sub>	-40	V
Emitter-Base Voltage	V <sub>EBO</sub>	-5.0	V
Collector Current - Continuous (Note 1)	I <sub>C</sub>	-600	mA

- Notes:
1. Device mounted on FR-4 PCB, 1 inch x 0.85 inch x 0.062 inch; pad layout as shown on Diodes Inc. suggested pad layout document AP02001, which can be found on our website at <http://www.diodes.com/datasheets/ap02001.pdf>.
  2. Maximum combined dissipation.
  3. No purposefully added lead.

## Electrical Characteristics, NPN 4401 Section @<sub>T<sub>A</sub></sub> = 25°C unless otherwise specified

Characteristic	Symbol	Min	Max	Unit	Test Condition
<b>OFF CHARACTERISTICS (Note 4)</b>					
Collector-Base Breakdown Voltage	$V_{(BR)CBO}$	60	—	V	$I_C = 100\mu A, I_E = 0$
Collector-Emitter Breakdown Voltage	$V_{(BR)CEO}$	40	—	V	$I_C = 1.0mA, I_B = 0$
Emitter-Base Breakdown Voltage	$V_{(BR)EBO}$	6.0	—	V	$I_E = 100\mu A, I_C = 0$
Collector Cutoff Current	$I_{CEX}$	—	100	nA	$V_{CE} = 35V, V_{EB(OFF)} = 0.4V$
Base Cutoff Current	$I_{BL}$	—	100	nA	$V_{CE} = 35V, V_{EB(OFF)} = 0.4V$
<b>ON CHARACTERISTICS (Note 4)</b>					
DC Current Gain	$h_{FE}$	20	—	—	$I_C = 100\mu A, V_{CE} = 1.0V$ $I_C = 1.0mA, V_{CE} = 1.0V$ $I_C = 10mA, V_{CE} = 1.0V$ $I_C = 150mA, V_{CE} = 1.0V$ $I_C = 500mA, V_{CE} = 2.0V$
		40	—		
		80	—		
		100	300		
		40	—		
Collector-Emitter Saturation Voltage	$V_{CE(SAT)}$	—	0.40 0.75	V	$I_C = 150mA, I_B = 15mA$ $I_C = 500mA, I_B = 50mA$
Base-Emitter Saturation Voltage	$V_{BE(SAT)}$	0.75	0.95 1.2	V	$I_C = 150mA, I_B = 15mA$ $I_C = 500mA, I_B = 50mA$
<b>SMALL SIGNAL CHARACTERISTICS</b>					
Output Capacitance	$C_{cb}$	—	6.5	pF	$V_{CB} = 5.0V, f = 1.0MHz, I_E = 0$
Input Capacitance	$C_{eb}$	—	30	pF	$V_{EB} = 0.5V, f = 1.0MHz, I_C = 0$
Input Impedance	$h_{ie}$	1.0	15	k $\Omega$	$V_{CE} = 10V, I_C = 1.0mA,$ $f = 1.0kHz$
Voltage Feedback Ratio	$h_{re}$	0.1	8.0	$\times 10^{-4}$	
Small Signal Current Gain	$h_{fe}$	40	500	—	
Output Admittance	$h_{oe}$	1.0	30	$\mu S$	
Current Gain-Bandwidth Product	$f_T$	250	—	MHz	
<b>SWITCHING CHARACTERISTICS</b>					
Delay Time	$t_d$	—	15	ns	$V_{CC} = 30V, I_C = 150mA,$
Rise Time	$t_r$	—	20	ns	$V_{BE(off)} = 2.0V, I_{B1} = 15mA$
Storage Time	$t_s$	—	225	ns	$V_{CC} = 30V, I_C = 150mA,$
Fall Time	$t_f$	—	30	ns	$I_{B1} = I_{B2} = 15mA$

## Electrical Characteristics, PNP 4403 Section @<sub>T<sub>A</sub></sub> = 25°C unless otherwise specified

Characteristic	Symbol	Min	Max	Unit	Test Condition
<b>OFF CHARACTERISTICS (Note 4)</b>					
Collector-Base Breakdown Voltage	$V_{(BR)CBO}$	-40	—	V	$I_C = -100\mu A, I_E = 0$
Collector-Emitter Breakdown Voltage	$V_{(BR)CEO}$	-40	—	V	$I_C = -1.0mA, I_B = 0$
Emitter-Base Breakdown Voltage	$V_{(BR)EBO}$	-5.0	—	V	$I_E = -100\mu A, I_C = 0$
Collector Cutoff Current	$I_{CEX}$	—	-100	nA	$V_{CE} = -35V, V_{EB(OFF)} = -0.4V$
Base Cutoff Current	$I_{BL}$	—	-100	nA	$V_{CE} = -35V, V_{EB(OFF)} = -0.4V$
<b>ON CHARACTERISTICS (Note 4)</b>					
DC Current Gain	$h_{FE}$	30	—	—	$I_C = -100\mu A, V_{CE} = -1.0V$ $I_C = -1.0mA, V_{CE} = -1.0V$ $I_C = -10mA, V_{CE} = -1.0V$ $I_C = -150mA, V_{CE} = -2.0V$ $I_C = -500mA, V_{CE} = -2.0V$
		60	—		
		100	—		
		100	300		
		20	—		
Collector-Emitter Saturation Voltage	$V_{CE(SAT)}$	—	-0.40 -0.75	V	$I_C = -150mA, I_B = -15mA$ $I_C = -500mA, I_B = -50mA$
Base-Emitter Saturation Voltage	$V_{BE(SAT)}$	-0.75	-0.95 -1.30	V	$I_C = -150mA, I_B = -15mA$ $I_C = -500mA, I_B = -50mA$
<b>SMALL SIGNAL CHARACTERISTICS</b>					
Output Capacitance	$C_{cb}$	—	8.5	pF	$V_{CB} = -10V, f = 1.0MHz, I_E = 0$
Input Capacitance	$C_{eb}$	—	30	pF	$V_{EB} = -0.5V, f = 1.0MHz, I_C = 0$
Input Impedance	$h_{ie}$	1.5	15	k $\Omega$	$V_{CE} = -10V, I_C = -1.0mA,$ $f = 1.0kHz$
Voltage Feedback Ratio	$h_{re}$	0.1	8.0	$\times 10^{-4}$	
Small Signal Current Gain	$h_{fe}$	60	500	—	
Output Admittance	$h_{oe}$	1.0	100	$\mu S$	
Current Gain-Bandwidth Product	$f_T$	200	—	MHz	
<b>SWITCHING CHARACTERISTICS</b>					
Delay Time	$t_d$	—	15	ns	$V_{CC} = -30V, I_C = -150mA,$
Rise Time	$t_r$	—	20	ns	$V_{BE(off)} = -2.0V, I_{B1} = -15mA$
Storage Time	$t_s$	—	225	ns	$V_{CC} = -30V, I_C = -150mA,$
Fall Time	$t_f$	—	30	ns	$I_{B1} = I_{B2} = -15mA$

Notes: 4. Short duration pulse test used to minimize self-heating effect.

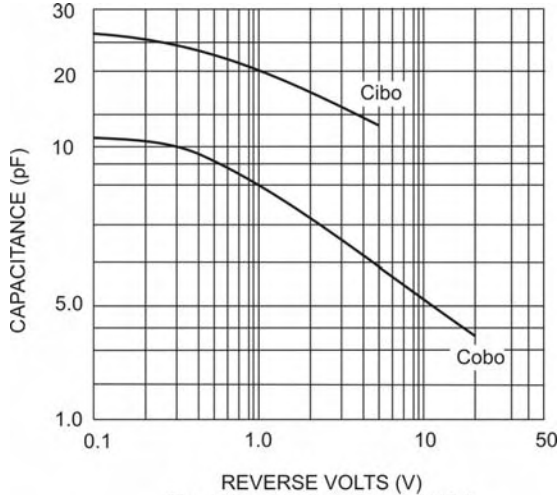

Fig. 1 Typical Capacitance (4401)

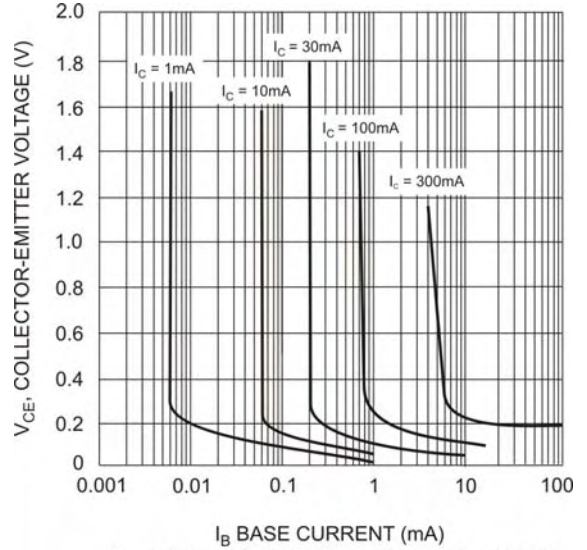

Fig. 2 Typical Collector Saturation Region (4401)

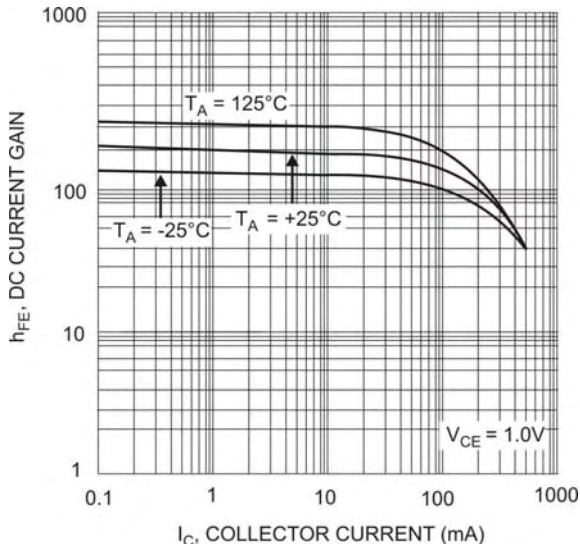

Fig. 3 Typical DC Current Gain vs Collector Current (4401)

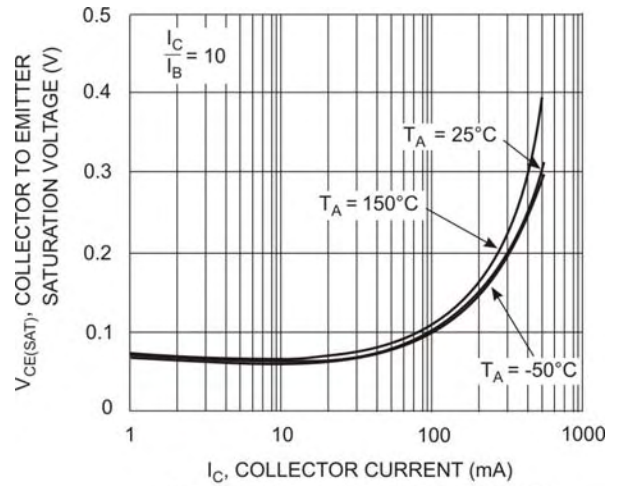

Fig. 4 Collector Emitter Saturation Voltage vs. Collector Current (4401)

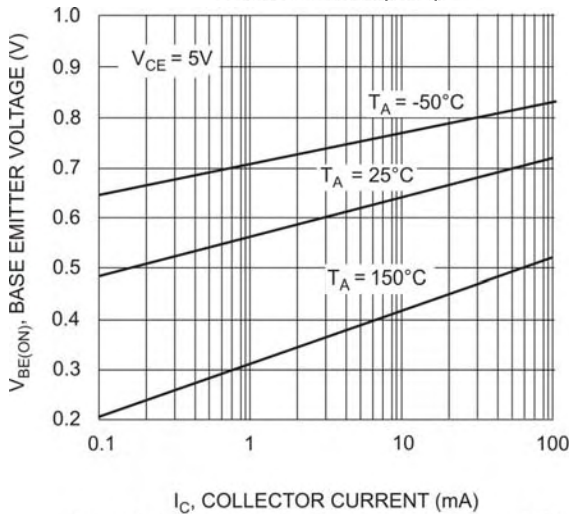

Fig. 5 Base Emitter Voltage vs. Collector Current (4401)

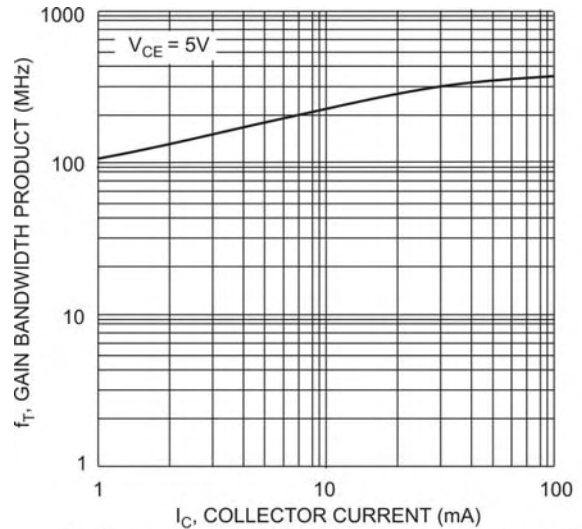

Fig. 6 Gain Bandwidth Product vs. Collector Current (4401)

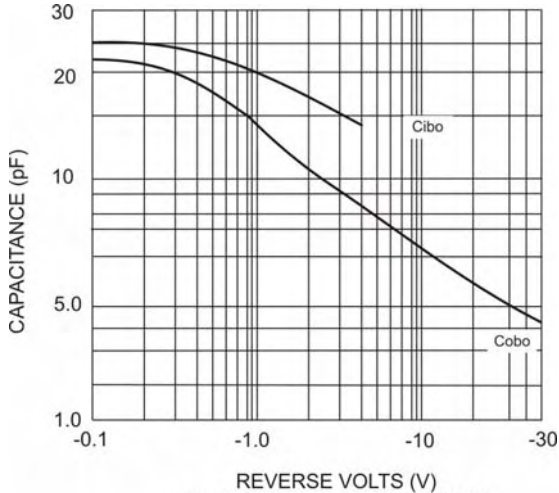

Fig. 7 Typical Capacitance (4403)

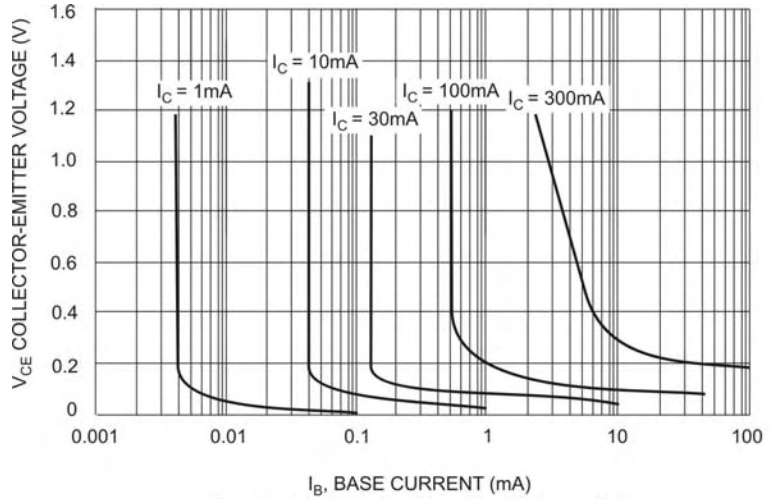

Fig. 8 Typical Collector Saturation Region (4403)

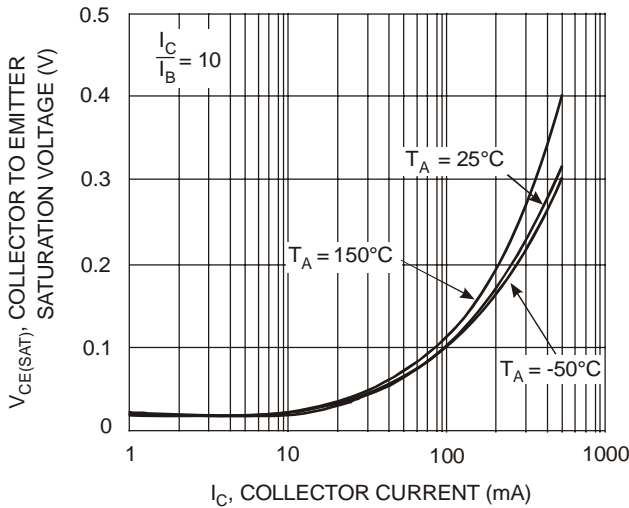

Fig. 9 Collector Emitter Saturation Voltage vs. Collector Current (4403)

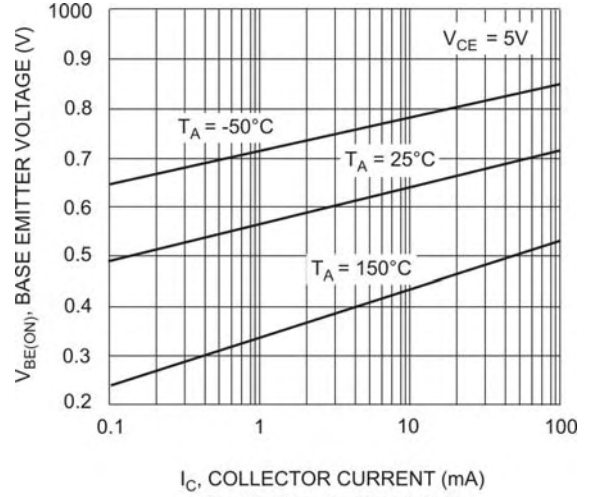

Fig. 10 Base-Emitter Voltage vs. Collector Current (4403)

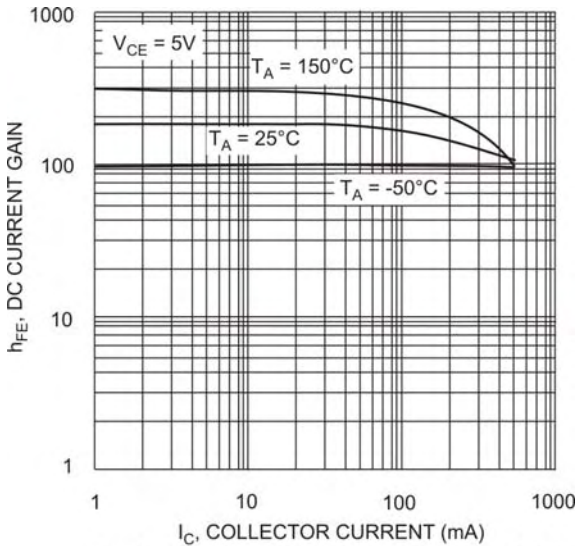

Fig. 11 DC Current Gain vs. Collector Current (4403)

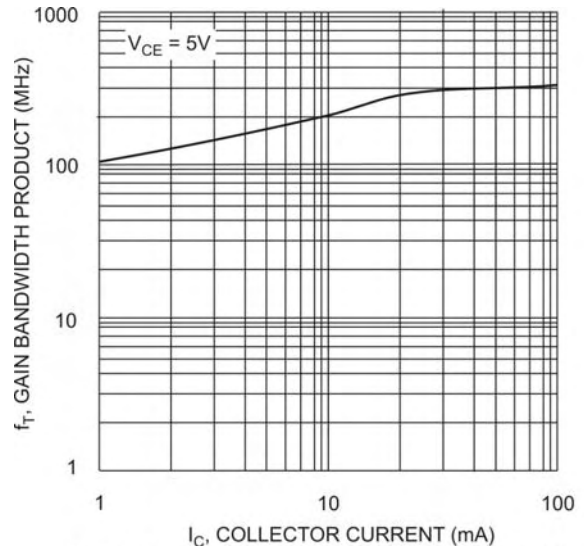
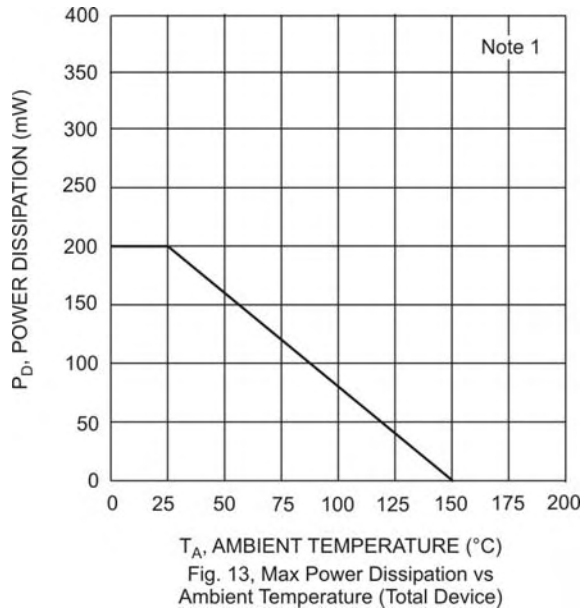

Fig. 12 Gain Bandwidth Product vs. Collector Current (4403)



## Ordering Information (Note 5)

Device	Packaging	Shipping
MMDT4413-7-F	SOT-363	3000/Tape & Reel

Notes: 5. For Packaging Details, go to our website at <http://www.diodes.com/datasheets/ap02007.pdf>.

## Marking Information

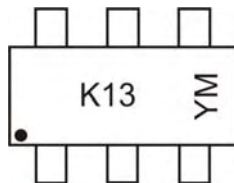

K13= Product Type Marking Code  
 YM = Date Code Marking  
 Y = Year ex: N = 2002  
 M = Month ex: 9 = September

### Data Code Key

Year	1998	1999	2000	2001	2002	2003	2004	2005	2006	2007	2008	2009	2010	2011	2012
Code	J	K	L	M	N	P	R	S	T	U	V	W	X	Y	Z

Month	Jan	Feb	Mar	Apr	May	Jun	Jul	Aug	Sep	Oct	Nov	Dec
Code	1	2	3	4	5	6	7	8	9	O	N	D

### IMPORTANT NOTICE

Diodes Incorporated and its subsidiaries reserve the right to make modifications, enhancements, improvements, corrections or other changes without further notice to any product herein. Diodes Incorporated does not assume any liability arising out of the application or use of any product described herein; neither does it convey any license under its patent rights, nor the rights of others. The user of products in such applications shall assume all risks of such use and will agree to hold Diodes Incorporated and all the companies whose products are represented on our website, harmless against all damages.

### LIFE SUPPORT

Diodes Incorporated products are not authorized for use as critical components in life support devices or systems without the expressed written approval of the President of Diodes Incorporated.