

Industry's Most Innovative

PCB LED

Products
ENGINEERING DESIGN GUIDE

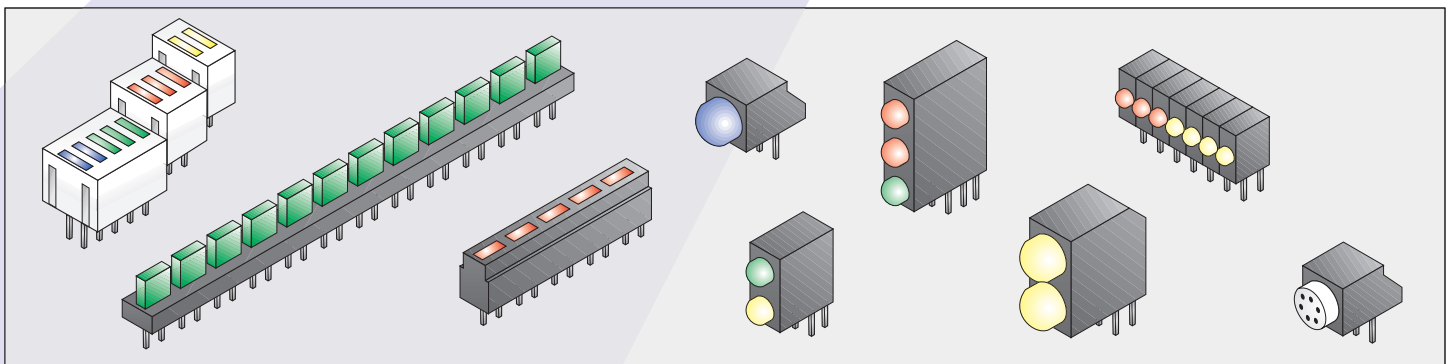
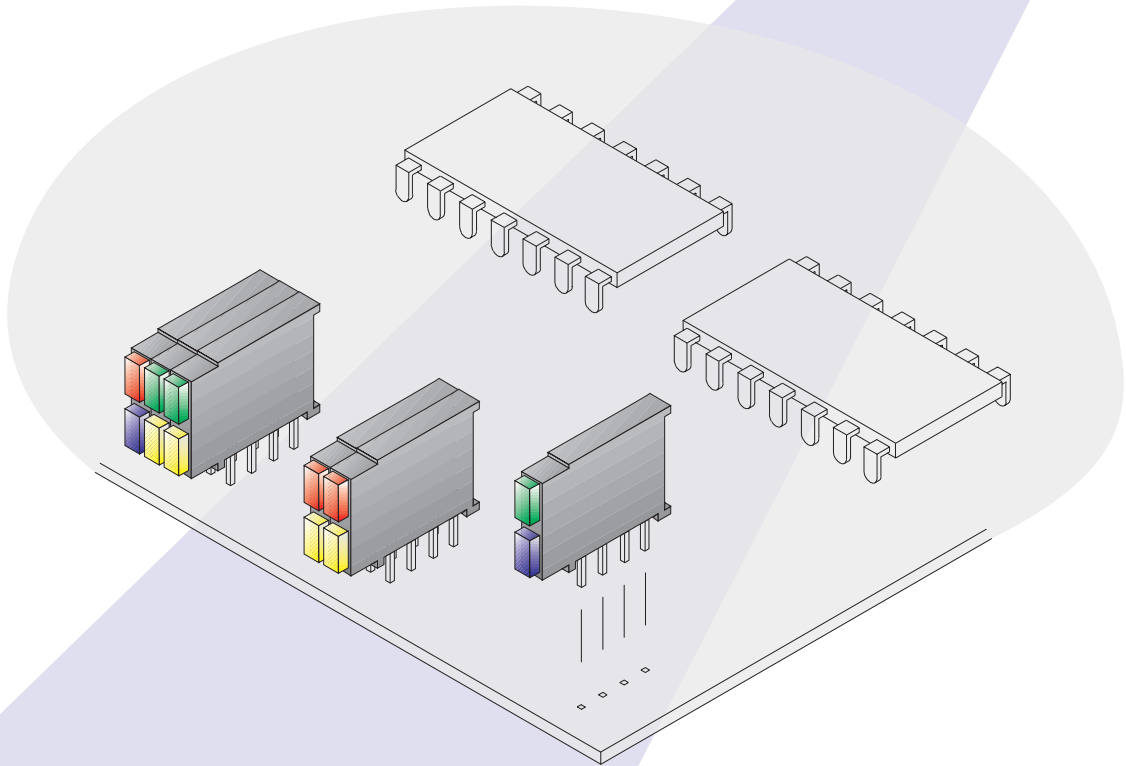
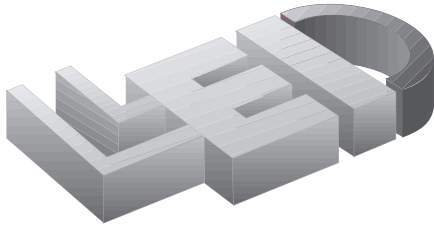

BARGRAPHS • SINGLE LEVEL • BILEVEL • TRILEVEL • T3/4 • T1 • T1-3/4

LEDTRONICS
More Choices, More Light

Fast Delivery, Quality Parts, & Standard Packages

SINGLE LEVEL T³/₄ (2mm) LEDs

PART NO.	COLOR	mA	Vf	Iv mcd	
555M-2001	DEEP RED	10	1.6/2.0	1.3/3.2	
555M-2101	HI-EFF RED	10	1.8/3.0	1.0/3.0	
555M-2301	GREEN	10	2.0/3.0	1.0/3.0	
555M-2401	YELLOW	10	2.0/3.0	1.0/3.0	
555M-2003	DEEP RED	6	5.0/6.0	0.6/1.2	*
555M-2004	DEEP RED	16	5.0/6.0	1.0/3.0	*
555M-2007	HI-EFF RED	3	5.0/6.0	0.8/2.0	*
555M-2303	GREEN	5	5.0/6.0	0.2/0.5	*
555M-2403	YELLOW	5	5.0/6.0	0.3/0.6	*

NOTES:
SCALE 2=1
HOUSING MATERIAL IS NYLON 66 (UL 94V-0)
ALL "Vf" READINGS ARE TYP/MAX
ALL "mcd" READINGS ARE MIN/TYP
"*" DENOTES LED WITH INTEGRATED RESISTOR

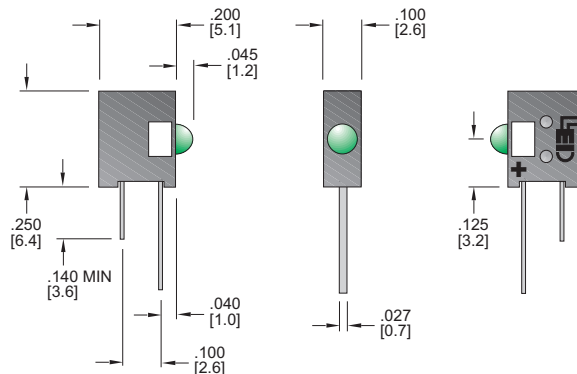

Options

-SI

SNAP IN



PART NO.	COLOR	mA	Vf	Iv mcd	
555M-3001	DEEP RED	10	1.6/2.0	1.3/3.2	
555M-3101	HI-EFF RED	10	1.8/3.0	1.0/3.0	
555M-3301	GREEN	10	2.0/3.0	1.0/3.0	
555M-3401	YELLOW	10	2.0/3.0	1.0/3.0	
555M-3003	DEEP RED	6	5.0/6.0	0.6/1.2	*
555M-3004	DEEP RED	16	5.0/6.0	1.0/3.0	*
555M-3007	HI-EFF RED	3	5.0/6.0	0.8/2.0	*
555M-3303	GREEN	5	5.0/6.0	0.2/0.5	*
555M-3403	YELLOW	5	5.0/6.0	0.3/0.6	*

NOTES:
SCALE 2=1
HOUSING MATERIAL IS NYLON 66 (UL 94V-0)
ALL "Vf" READINGS ARE TYP/MAX
ALL "mcd" READINGS ARE MIN/TYP
"*" DENOTES LED WITH INTEGRATED RESISTOR

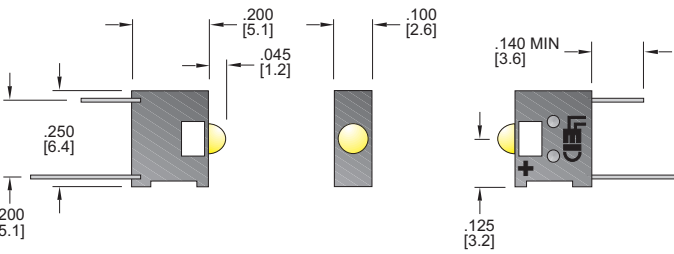

Options

-SI

SNAP IN



PART NO.	COLOR	mA	Vf	Iv mcd	
SM555-2001	DEEP RED	10	1.6/2.0	1.3/3.2	
SM555-2101	HI-EFF RED	10	1.8/3.0	1.0/3.0	
SM555-2301	GREEN	10	2.0/3.0	1.0/3.0	
SM555-2401	YELLOW	10	2.0/3.0	1.0/3.0	
SM555-2003	DEEP RED	6	5.0/6.0	0.6/1.2	*
SM555-2004	DEEP RED	16	5.0/6.0	1.0/3.0	*
SM555-2007	HI-EFF RED	3	5.0/6.0	0.8/2.0	*
SM555-2303	GREEN	5	5.0/6.0	0.2/0.5	*
SM555-2403	YELLOW	5	5.0/6.0	0.3/0.6	*

NOTES:
SCALE 2=1
HOUSING MATERIAL IS RYNITE (UL 94HB)
ALL "Vf" READINGS ARE TYP/MAX
ALL "mcd" READINGS ARE MIN/TYP
"*" DENOTES LED WITH INTEGRATED RESISTOR

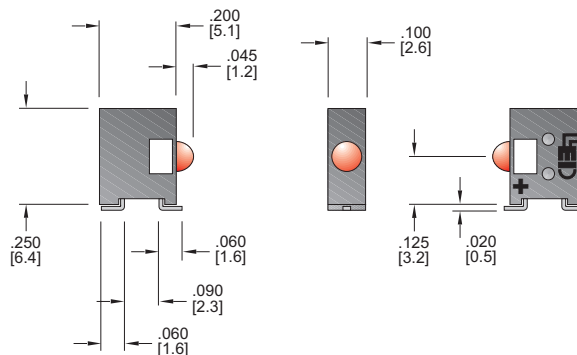

Options

-SI

SNAP IN



-P

LOCATING PIN



.028 SQ x .060 TAB

PART NO.	COLOR	mA	Vf	Iv mcd	
SM555-3001	DEEP RED	10	1.6/2.0	1.3/3.2	
SM555-3101	HI-EFF RED	10	1.8/3.0	1.0/3.0	
SM555-3301	GREEN	10	2.0/3.0	1.0/3.0	
SM555-3401	YELLOW	10	2.0/3.0	1.0/3.0	
SM555-3003	DEEP RED	6	5.0/6.0	0.6/1.2	*
SM555-3004	DEEP RED	16	5.0/6.0	1.0/3.0	*
SM555-3007	HI-EFF RED	3	5.0/6.0	0.8/2.0	*
SM555-3303	GREEN	5	5.0/6.0	0.2/0.5	*
SM555-3403	YELLOW	5	5.0/6.0	0.3/0.6	*

NOTES:
SCALE 2=1
HOUSING MATERIAL IS RYNITE (UL 94HB)
ALL "Vf" READINGS ARE TYP/MAX
ALL "mcd" READINGS ARE MIN/TYP
"*" DENOTES LED WITH INTEGRATED RESISTOR

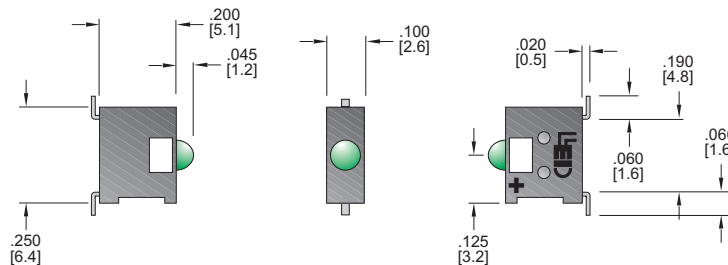

Options

-SI

SNAP IN



LEADS ARE CUT TO .140 ON ALL ARRAYS
FOR "555M" SERIES

Arrays



SINGLE LEVEL T1 (3mm) LEDs

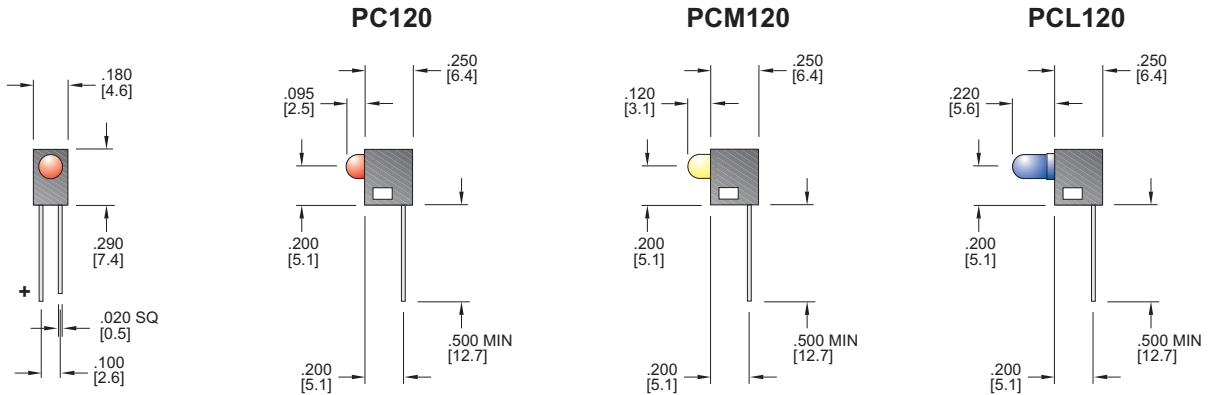
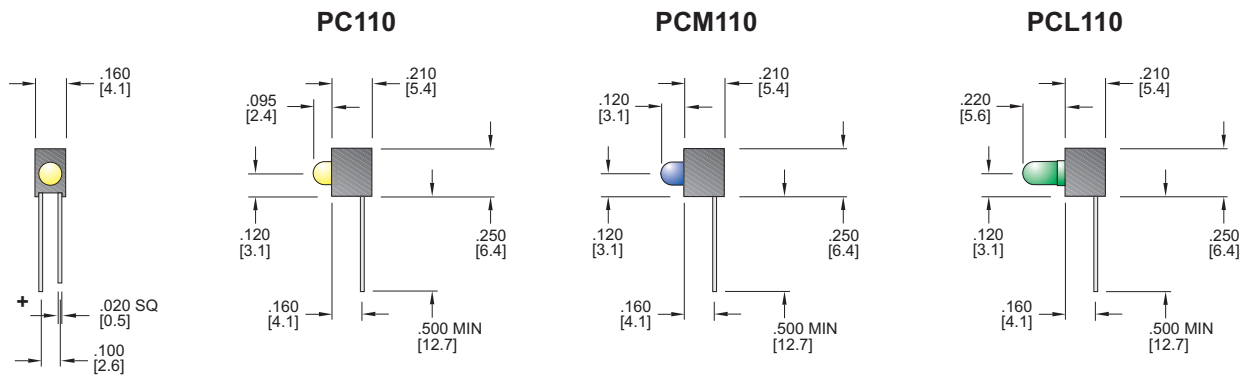

Options

-SO
STAND OFF

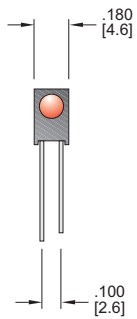

-P
LOCATING PIN

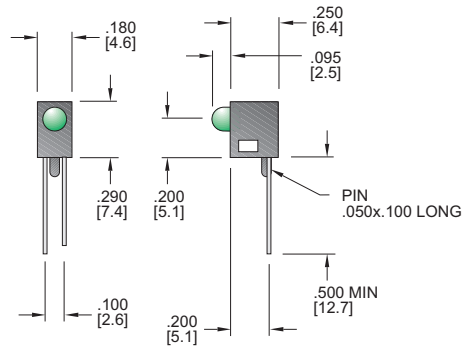

Arrays

12PC120

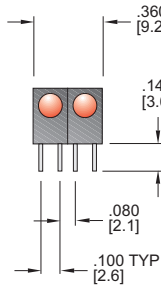

13PC120

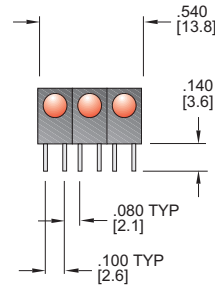

14PC120

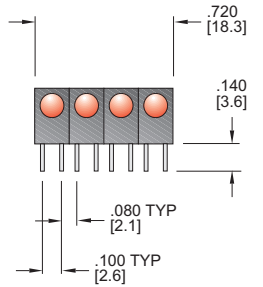

CODE	COLOR	mA	Vf	Iv mcd
R	RED	10/30	2.0/2.8	1.7/5.6
Y	YELLOW	10/20	2.1/2.8	1.7/5.5
G	GREEN	10/30	2.1/2.8	1.7/5.6
B	BLUE	20/30	3.2/3.7	2.0/3.5

SPECIALS

- ALL "Vf" READINGS ARE TYP/MAX
- ALL "mcd" READINGS ARE MIN/TYP
- 5V = 5 VOLT INTEGRATED RESISTOR
- LC = LOW CURRENT 2mA LEDs
- X = DENOTES BLANK LED SPACE
- CONSULT FACTORY ON PART NUMBERS FOR ARRAYS WITH NONCONSECUTIVE COLORS

SAMPLE PART NUMBER:

PC120TX4

LED COLOR

BILEVEL T1 (3mm) LEDs

24PCT110

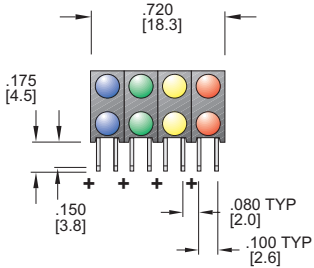

23PCT110

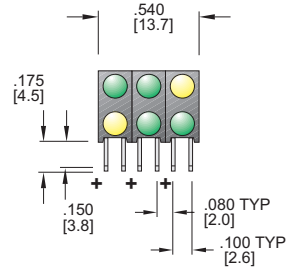

22PCT110

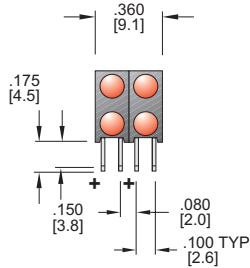

21PCT110

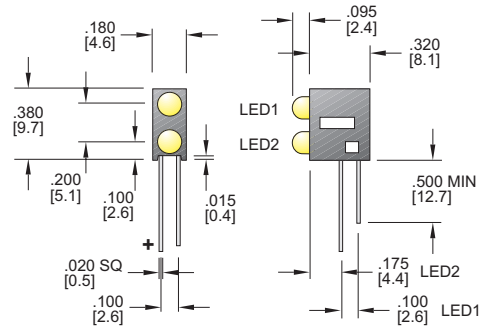

24PCT120

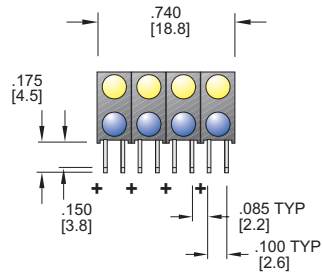

23PCT120

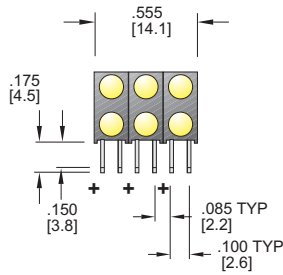

22PCT120

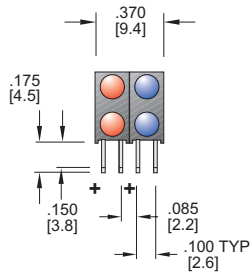

21PCT120

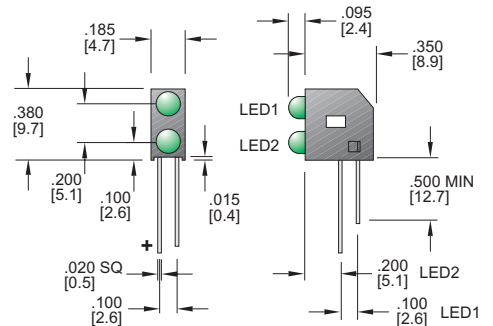

24PCT170

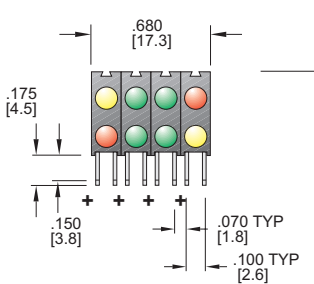

23PCT170

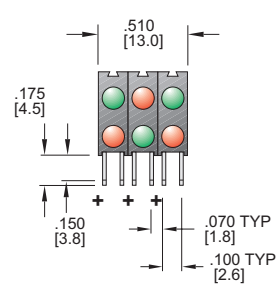

22PCT170

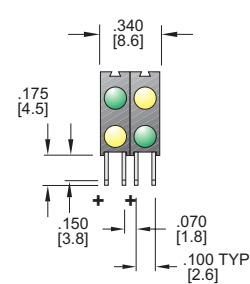

21PCT170

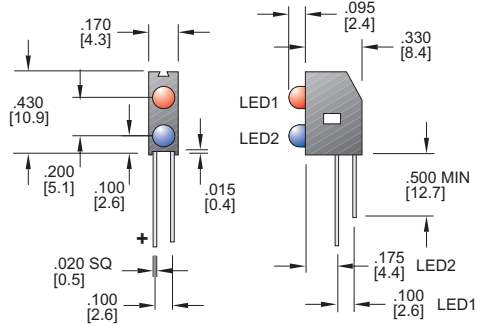

Options

21PCM120

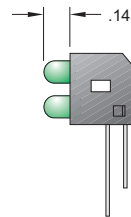

21PCL120

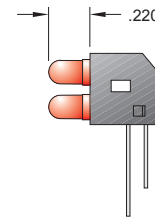

CODE	COLOR	mA	Vf	Iv mcd
R	RED	10/30	2.0/2.8	1.7/5.6
Y	YELLOW	10/20	2.1/2.8	1.7/5.5
G	GREEN	10/30	2.1/2.8	1.7/5.6
B	BLUE	20/30	3.2/3.7	2.0/3.5

SAMPLE PART NUMBER:

23PCT170T4-X/X

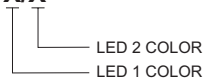

SPECIALS

- ALL "Vf" READINGS ARE TYP/MAX
- ALL "mcd" READINGS ARE MIN/TYP
- 5V = 5 VOLT INTEGRATED RESISTOR
- LC = LOW CURRENT 2mA LEDs
- X = DENOTES BLANK LED SPACE
- CONSULT FACTORY ON PART NUMBERS FOR ARRAYS WITH NONCONSECUTIVE COLORS

TRILEVEL T1 (3mm) LEDs

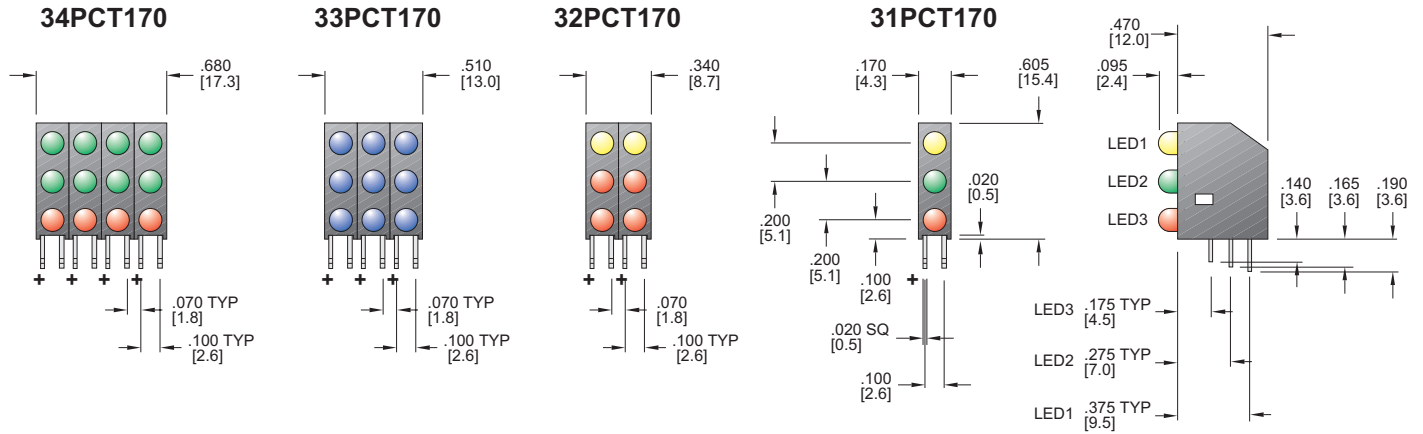
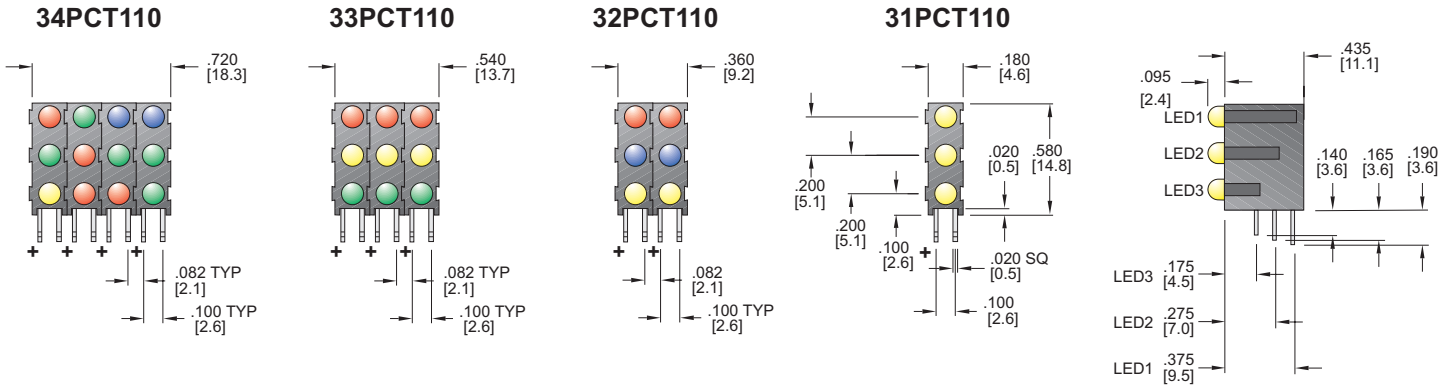

CODE	COLOR	mA	Vf	lv mcd
R	RED	10/30	2.0/2.8	1.7/5.6
Y	YELLOW	10/20	2.1/2.8	1.7/5.5
G	GREEN	10/30	2.1/2.8	1.7/5.6
B	BLUE	20/30	3.2/3.7	2.0/3.5

SPECIALS

- ALL "Vf" READINGS ARE TYP/MAX
- ALL "mcd" READINGS ARE MIN/TYP
- 5V = 5 VOLT INTEGRATED RESISTOR
- LC = LOW CURRENT 2mA LEDs
- X = DENOTES BLANK LED SPACE
- CONSULT FACTORY ON PART NUMBERS FOR ARRAYS WITH NONCONSECUTIVE COLORS

SAMPLE PART NUMBER:

31PCT170T4-X/X/X

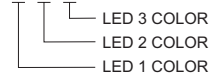

QUADLEVEL T1 (3mm) LEDs

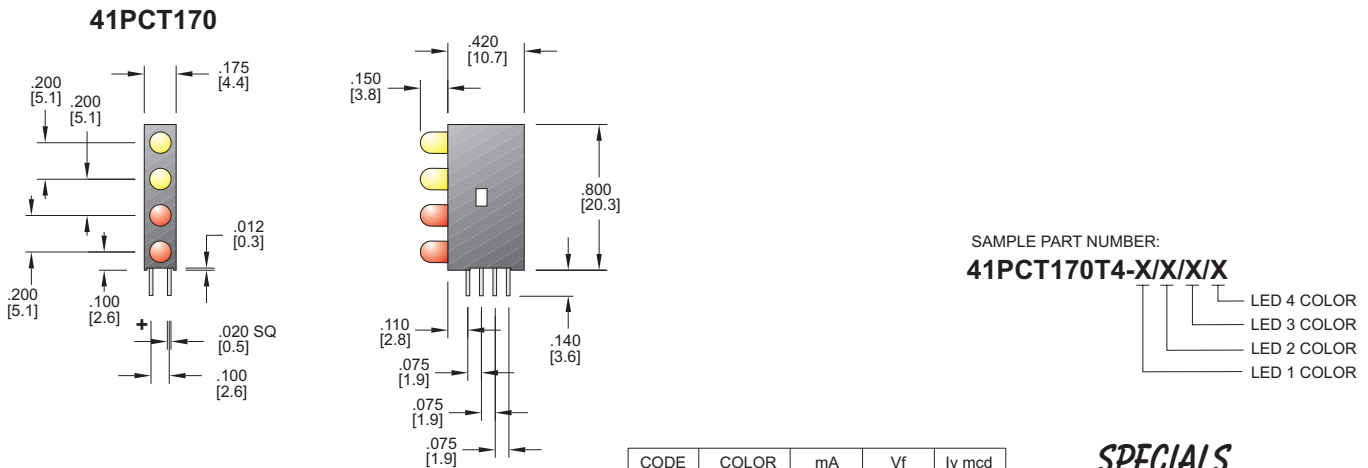

SAMPLE PART NUMBER:

41PCT170T4-X/X/X/X

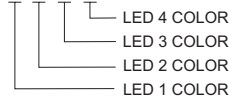

CODE	COLOR	mA	Vf	lv mcd
R	RED	10/30	2.0/2.8	1.7/5.6
Y	YELLOW	10/20	2.1/2.8	1.7/5.5
G	GREEN	10/30	2.1/2.8	1.7/5.6
B	BLUE	20/30	3.2/3.7	2.0/3.5

SPECIALS

- ALL "Vf" READINGS ARE TYP/MAX
- ALL "mcd" READINGS ARE MIN/TYP
- 5V = 5 VOLT INTEGRATED RESISTOR
- LC = LOW CURRENT 2mA LEDs
- X = DENOTES BLANK LED SPACE

SINGLE LEVEL T1^{3/4} (5mm) LEDs

PC190

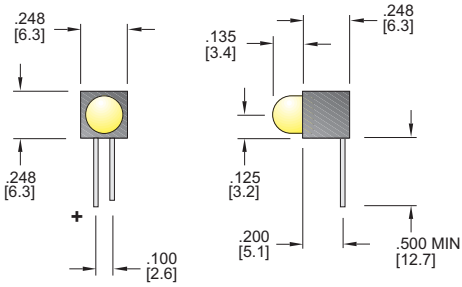

PCT190

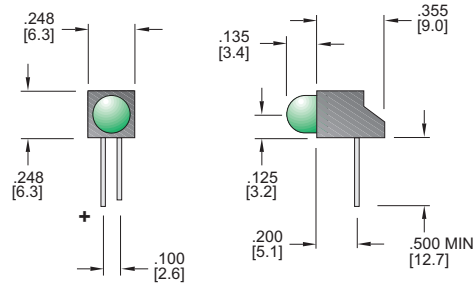

PCV190

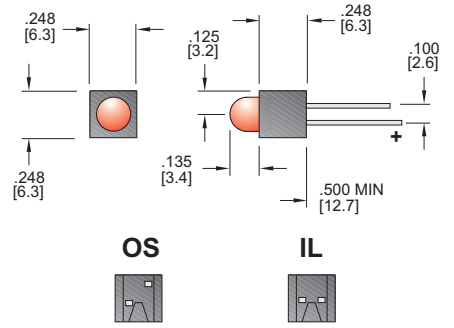

PC200

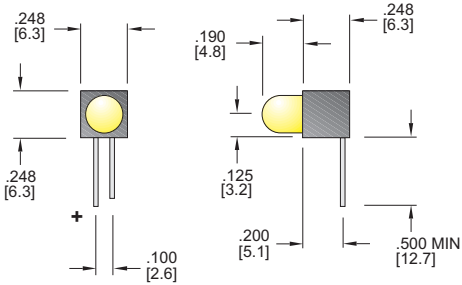

PCT200

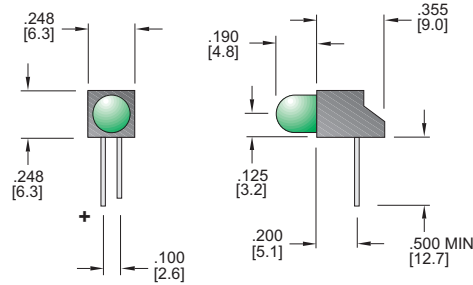

PCV200

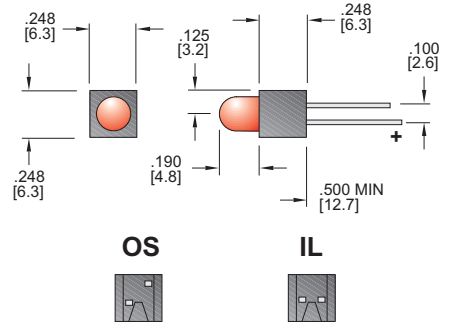

Options

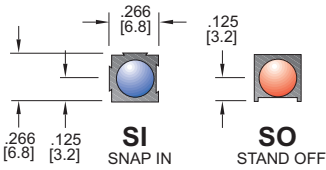

Arrays

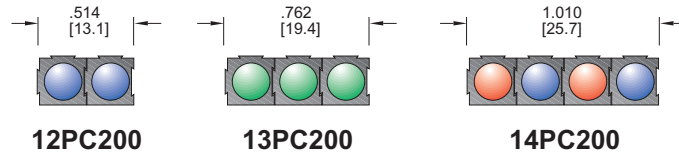

ALSO AVAILABLE FOR PCT200, PCV200, PC190, PCT190, PCV190

PCT220

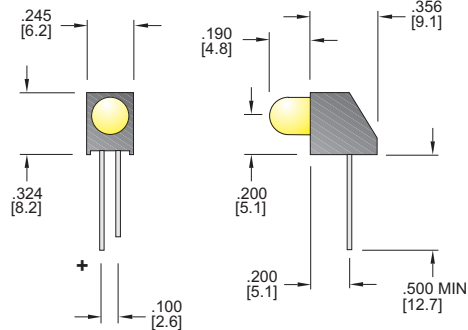

PCT230

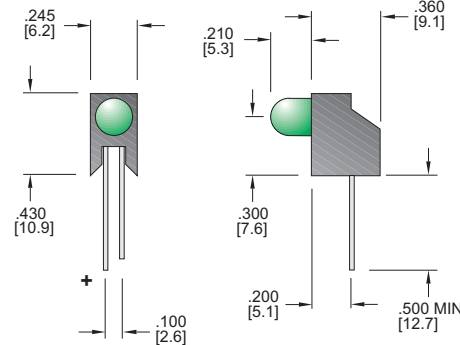

PCT240

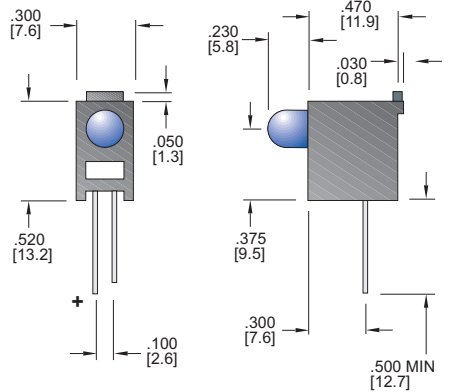

CODE	COLOR	mA	Vf	Iv mcd
R	RED	20/30	2.0/2.8	12/38
Y	YELLOW	20/30	2.1/2.8	8/25
G	GREEN	20/30	2.2/2.8	8/25
B	BLUE	20/30	3.2/3.7	4/8

SPECIALS

- ALL "Vf" READINGS ARE TYP/MAX
- ALL "mcd" READINGS ARE MIN/TYP
- 5V = 5 VOLT INTEGRATED RESISTOR
- LC = LOW CURRENT 2mA LEDs
- X = DENOTES BLANK LED SPACE
- CONSULT FACTORY ON PART NUMBERS FOR ARRAYS WITH NONCONSECUTIVE COLORS

SAMPLE PART NUMBER:

PCT200TX4

LED COLOR

SINGLE LEVEL BICOLOR T1³/₄ (5mm) LEDs

PCT200
BICOLOR

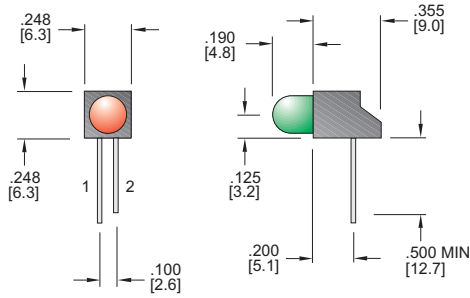

PCT200-3C / 3A
TRICOLOR

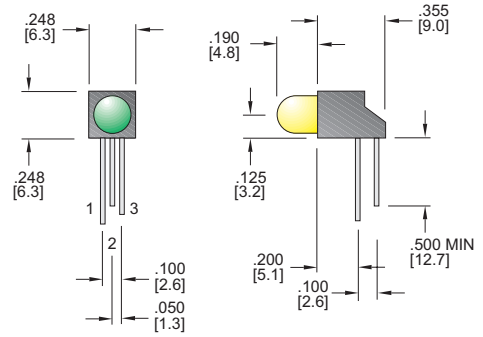

Options

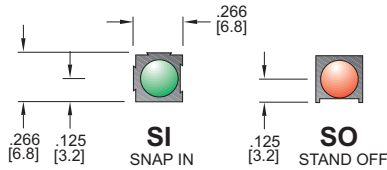

Arrays

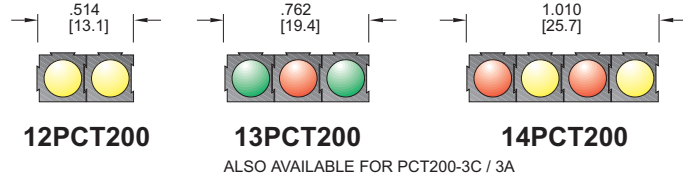

PC300-T
TRICOLOR WITH TAB

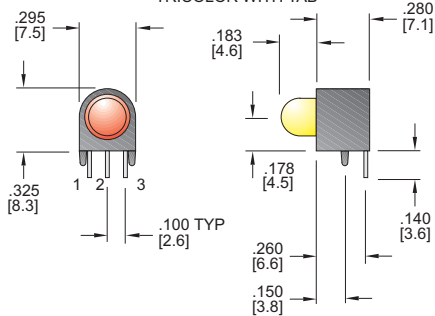

PCT300
TRICOLOR

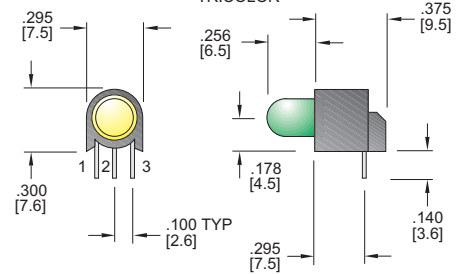

PCT300
TRICOLOR WITHOUT TAB

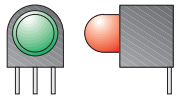

CODE	COLOR	mA	Vf	Iv mcd		PIN 1	PIN 2	PIN 3
TWRG4B	RED	20/30	2.0/2.8	3.0/6.0		RED +	GRN +	----
	GREEN	20/30	2.1/2.8	3.0/6.0				
TWYG4B	YELLOW	20/30	2.1/2.8	2.5/5.0		YLW +	GRN +	----
	GREEN	20/30	2.1/2.8	3.0/6.0				
TWRG4B-3C	RED	20/30	2.0/2.8	3.0/6.0		RED +	CC -	GRN +
	GREEN	20/30	2.1/2.8	3.0/6.0				
TWYG4B-3C	YELLOW	20/30	2.1/2.8	2.5/5.0		YLW +	CC -	GRN +
	GREEN	20/30	2.1/2.8	3.0/6.0				
TWRY4B-3C	RED	20/30	2.0/2.8	3.0/6.0		RED +	CC -	YLW +
	YELLOW	20/30	2.1/2.8	2.5/5.0				
TWRG4B-3A	RED	20/30	2.0/2.8	3.0/6.0		CA +	RED -	GRN -
	GREEN	20/30	2.1/2.8	3.0/6.0				
TWYG4B-3A	YELLOW	20/30	2.1/2.8	2.5/5.0		CA +	YLW -	GRN -
	GREEN	20/30	2.1/2.8	3.0/6.0				

SPECIALS

- ALL "Vf" READINGS ARE TYP/MAX
- ALL "mcd" READINGS ARE MIN/TYP
- X = DENOTES BLANK LED SPACE
- CONSULT FACTORY ON PART NUMBERS FOR ARRAYS WITH NONCONSECUTIVE COLORS
- REVERSE MIDDLE TWO COLOR CHARACTERS FOR REVERSE COLOR COMBINATION
- 3C IS COMMON CATHODE
- 3A IS COMMON ANODE

SAMPLE PART NUMBER:

PCT200TWXX4B-3C

LED COLOR

BILEVEL T1³/₄ (5mm) LEDs

21PCS190

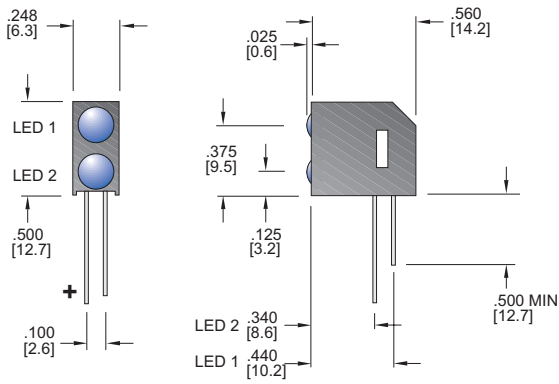

21PCS200

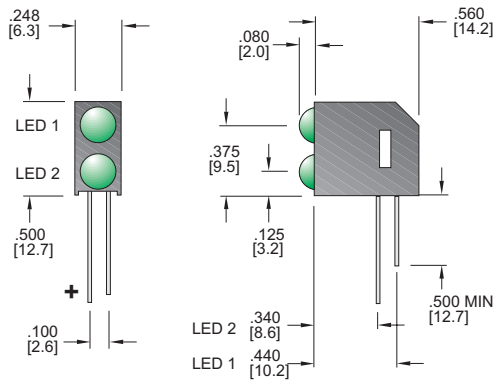

21PCT190

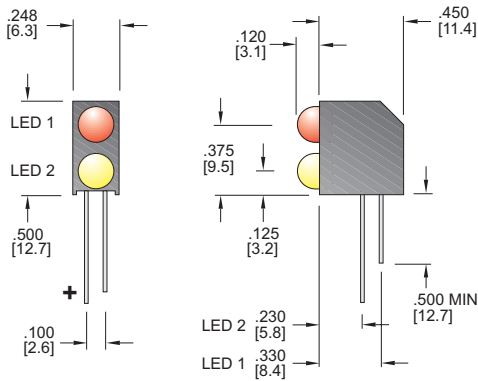

21PCT200

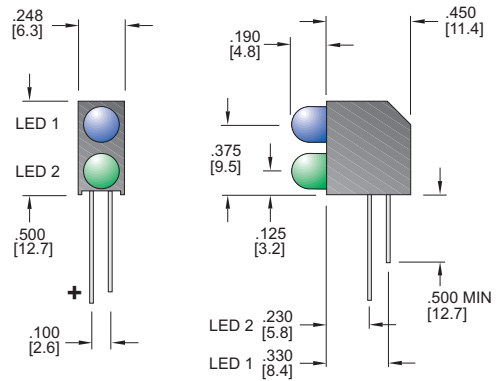

24PCT200-SI

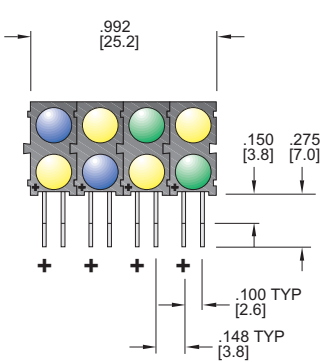

23PCT200-SI

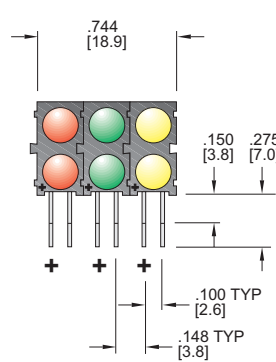

22PCT200-SI

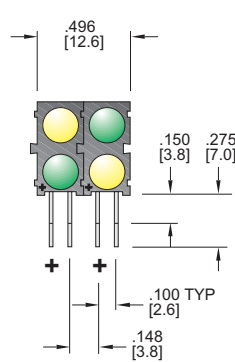

21PCT200-SI

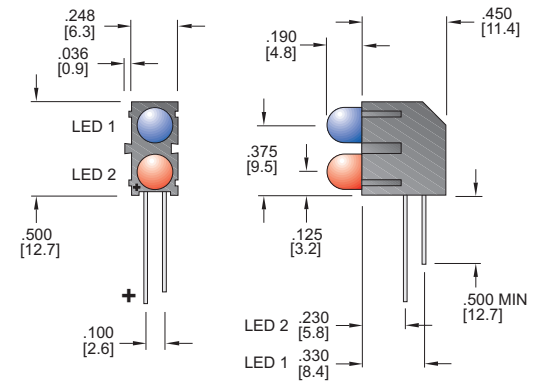

21PCT190-SI

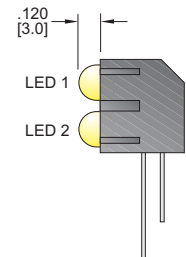

SAMPLE PART NUMBER:

22PCT200T4-X/X-SI

SPECIAL OPTIONS
LED 2 COLOR
LED 1 COLOR

CODE	COLOR	mA	Vf	Iv mcd
R	RED	20/30	2.0/2.8	12/38
Y	YELLOW	20/30	2.1/2.8	8/25
G	GREEN	20/30	2.2/2.8	8/25
B	BLUE	20/30	3.2/3.7	4/8

SPECIALS

- ALL "Vf" READINGS ARE TYP/MAX
- ALL "mcd" READINGS ARE MIN/TYP
- 5V = 5 VOLT INTEGRATED RESISTOR
- LC = LOW CURRENT 2mA LEDs
- X = DENOTES BLANK LED SPACE
- CONSULT FACTORY ON PART NUMBERS FOR ARRAYS WITH NONCONSECUTIVE COLORS

SINGLE LEVEL RECTANGULAR LEDs

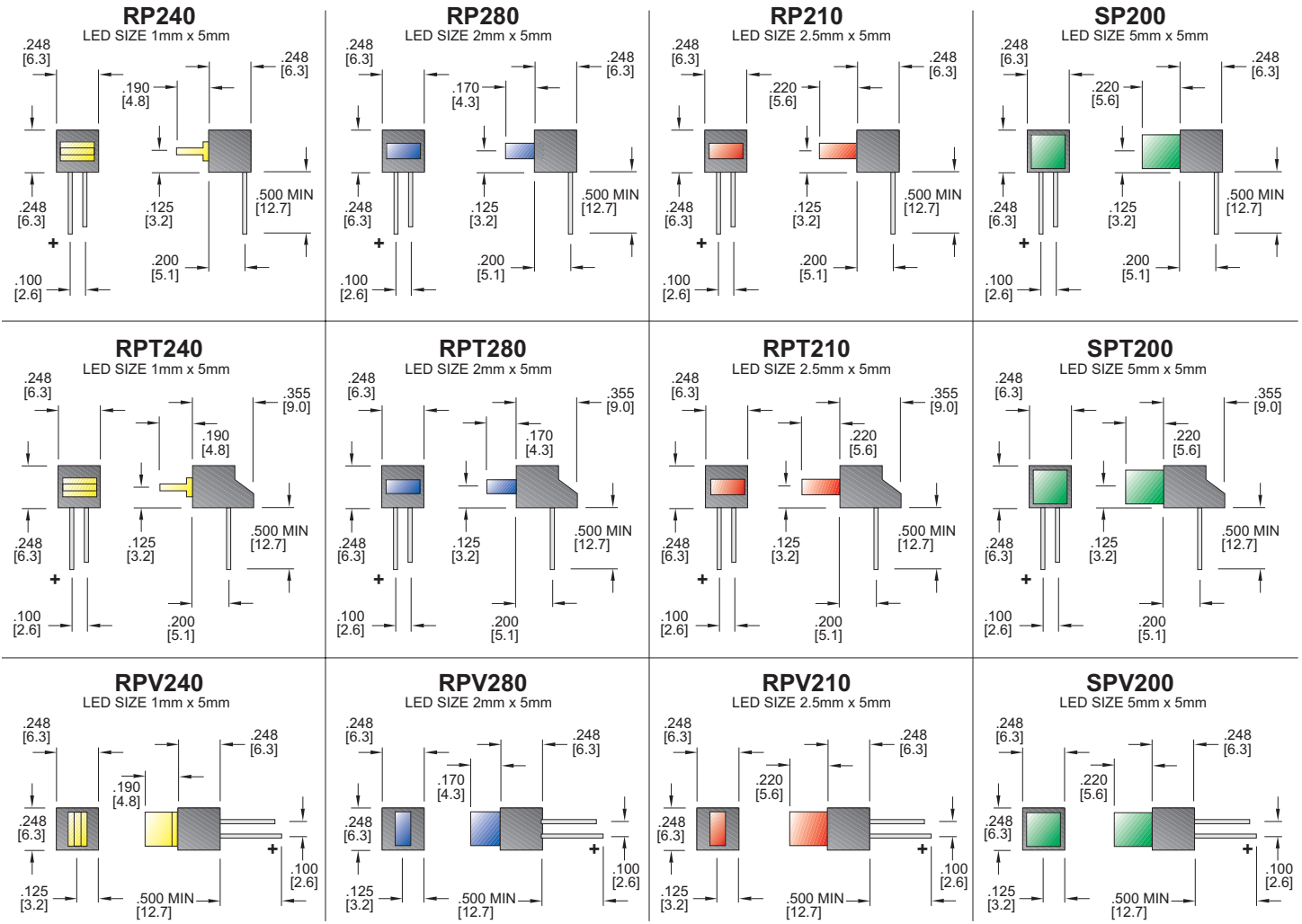

SERIES	CODE	COLOR	mA	Vf	Iv mcd
RP240	R	RED	10/30	2.0/2.8	2.0/4.0
RPT240	Y	YELLOW	10/30	2.1/2.8	1.5/3.0
RPV240	G	GREEN	10/30	2.1/2.8	1.5/3.0
	B	BLUE	30/50	3.2/3.7	0.5/0.8
RP280	R	RED	10/30	2.0/2.8	1.5/3.8
RPT280	Y	YELLOW	10/30	2.1/2.8	1.5/3.0
RPV280	G	GREEN	10/30	2.1/2.8	1.5/3.0
	B	BLUE	30/50	3.2/3.7	0.4/0.6

SERIES	CODE	COLOR	mA	Vf	Iv mcd
RP210	R	RED	10/30	2.0/2.8	1.0/2.0
RPT210	Y	YELLOW	10/30	2.1/2.8	1.0/2.0
RPV210	G	GREEN	10/30	2.1/2.8	2.5/4.5
SP200	R	RED	10/30	2.0/2.8	0.3/1.0
SPT200	Y	YELLOW	10/30	2.1/2.8	0.4/1.5
SPV200	G	GREEN	10/30	2.1/2.8	0.4/1.3

- ALL "Vf" READINGS ARE TYP/MAX
 - ALL "mcd" READINGS ARE MIN/TYP

SAMPLE PART NUMBER:
RP280X3
 LED COLOR

BILEVEL RECTANGULAR LEDs

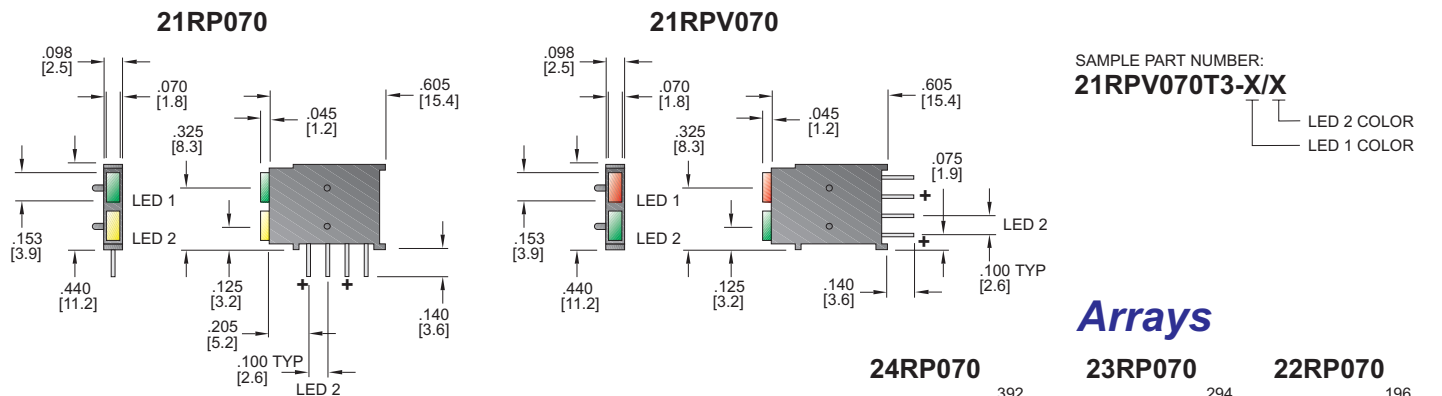

SAMPLE PART NUMBER:
21RPV070T3-X/X
 LED 2 COLOR
 LED 1 COLOR

Arrays

CODE	COLOR	mA	Vf	Iv mcd
R	RED	10/30	2.0/2.8	1.2/3.0
Y	YELLOW	10/30	2.1/2.8	1.0/2.3
G	GREEN	10/30	2.1/2.8	1.2/3.0
B	BLUE	30/35	3.2/3.7	0.6/1.1

SPECIALS
 - ALL "Vf" READINGS ARE TYP/MAX
 - ALL "mcd" READINGS ARE MIN/TYP
 - LC = LOW CURRENT 2mA LEDs
 - X = DENOTES BLANK LED SPACE
 - CONSULT FACTORY ON PART NUMBERS FOR ARRAYS WITH NONCONSECUTIVE COLORS

SURFACE MOUNT DISCRETE LEDs

2mm T 3/4 ROUND

L080-011



L080-021



L080-031



3mm T1 ROUND

SM110

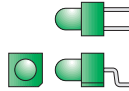

2mm T 3/4 ROUND

SML070



RECTANGULAR

SMRL070



SPECIALS

- BICOLOR LEDs
- SUPER BRIGHT LEDs
- LC = LOW CURRENT 2mA LEDs
- CALL FACTORY FOR DATA SHEETS ON SURFACE MOUNT PRODUCTS

SURFACE MOUNT PACKAGED LEDs

2mm T 3/4 ROUND

SM555-2XXX

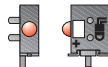

SEE PAGE 1

2mm T 3/4 ROUND

SM555-3XXX

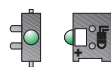

SEE PAGE 1

3mm T1 ROUND

SM120



SEE PAGE 2

5mm T 1-3/4 ROUND

SM200



SEE PAGE 5

1x5mm RECTANGULAR

SMR240

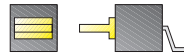

SEE PAGE 8

2x5mm RECTANGULAR

SMR280



SEE PAGE 8

SMV200

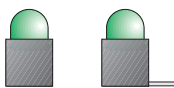

SEE PAGE 5

SMRV240

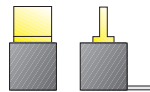

SEE PAGE 8

SMRV280

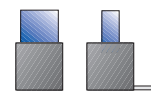

SEE PAGE 8

2.5x5mm RECTANGULAR

SMR210



SEE PAGE 8

5x5mm SQUARE

SMS200



SEE PAGE 8

5mm T 1-3/4 TRICOLOR

SM300

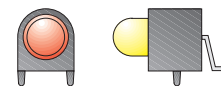

SEE PAGE 6

SMRV210

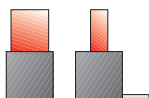

SEE PAGE 8

SMSV200

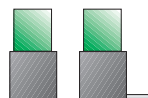

SEE PAGE 8

SPECIALS

- BICOLOR LEDs
- SUPER BRIGHT LEDs
- LC = LOW CURRENT 2mA LEDs
- CALL FACTORY FOR DATA SHEETS ON SURFACE MOUNT PRODUCTS

PANEL

T1-3/4 FLANGE
T3-1/4 BAYONET
TELEPHONE SLIDE
INTERMEDIATE BAYONET
T1-3/4 RELAMPABLE ASSEMBLY
1/2 SNAP-IN PANEL MOUNT
1/4 SNAP-IN PANEL MOUNT

BASED

BI-LEVEL ARRAYED RECT.
BARGRAPH PCB
T1-3/4 PCB
T1 TRI-LEVEL PCB
T3/4 ARRAYED PCB
T1 BI-LEVEL PCB
T1-3/4 BI-LEVEL PCB

DISCRETE

SQUARE
T1 ROUND
T1-3/4 ROUND
T1-3/4 RAINBOW
RECTANGULAR
RECTANGULAR

PCB

LEDTRONICS
More Choices, More Light
4009 PACIFIC COAST HWY. • TORRANCE, CA 90505
PHONE: (310)534-1505 • FAX:(310)534-1424

Ledtronics is the leader in LED manufacturing.

Innovators when it comes to solving your lighting problems. Ledtronics offers a full line of PCB, BASED, PANEL, & DISCRETE LEDs.

Along with these, Ledtronics has set an unprecedented record of custom designed products at realistic costs. Our engineering staff keeps abreast of industry's most challenging applications by creating hundreds of new parts each year.

Our commitment to excellence and customer satisfaction are just two reasons to choose Ledtronics. Shouldn't you call Ledtronics?