



Pb-free  
HEAT

**STANLEY**

# NU 1106W Series

Single Color Super Wide Angle Type (t=1.3 mm)

## Features

Package	Super Wide Angle Type (h=1.3 mm), Water Clear resin
Product features	<ul style="list-style-type: none"> <li>· Outer Dimension 2.5 x 2.0 x 1.3mm ( L x W x H )</li> <li>· Temperature range Storage Temperature : -40 ~ 120 Operating Temperature : -40 ~ 100</li> <li>· Lead-free soldering compatible</li> <li>· RoHS compliant</li> </ul>
Dominant wavelength	Yellow : 593nm(NUY) Orange : 612nm(NUA) Red : 638nm(NUR)
Half Intensity Angle	160 deg.
Die materials	AlGaInP
Rank grouping parameter	Sorted by luminous intensity and wavelength per rank taping
Assembly method	Auto pick & place machine (Auto Mounter)
Soldering methods	Reflow soldering and manual soldering
Taping and reel	2,500pcs per reel in a 8mm width tape. (Standard) Reel diameter: 180mm
ESD	2kV(HBM)

## Recommended Applications

Amusement Equipment, Electric Household Appliances, OA/FA, Other General Applications

**Color and Luminous Intensity**

(Ta=25 °C)

Part No.	Material	Emitted Color	Lens Color	Dominant Wavelength d (nm)		Luminous Intensity Iv (mcd)		
				TYP.	I <sub>F</sub>	MIN.	TYP.	I <sub>F</sub>
				NUY1106W	AlGaInP	Yellow	Water Clear	593
NUA1106W	AlGaInP	Orange	612	20	150	330		20
NUR1106W	AlGaInP	Red	638	20	68	220		20

## Absolute Maximum Ratings

(Ta=25 )

Item	Symbol	Absolute Maximum Ratings			Unit
		NUY	NUA	NUR	
Power Dissipation	$P_d$	81	81	81	mW
Forward Current	$I_F$	30	30	30	mA
Pulse Forward Current <sup>1</sup>	$I_{FRM}$	100	100	100	mA
Derating (Ta=85 or higher)	$I_F$	1.00	1.00	1.00	mA/
	$I_{FRM}$	3.33	3.33	3.33	mA/
Reverse Voltage	$V_R$	5	5	5	V
Operating Temperature	$T_{opr}$	-40 ~ +100			
Storage Temperature	$T_{stg}$	-40 ~ +120			

1  $I_{FRM}$  Measurement condition : Pulse Width 1ms., Duty 1/20.

## Electro-Optical Characteristics

(Ta=25 )

Item	Conditions	Symbol	Characteristics			Unit	
				NUY	NUA		NUR
Forward Voltage	$I_F=20mA$	$V_F$	TYP.	2.2	2.15	2.2	V
			MAX.	2.6	2.6	2.6	
Reverse Current	$V_R=5V$	$I_R$	MAX.	100	100	100	$\mu A$
Peak Wavelength	$I_F=20mA$	$\lambda_p$	TYP.	593	612	638	nm
Dominant Wavelength	$I_F=20mA$	$\lambda_d$	TYP.	589	605	626	nm
Spectral Line Half Width	$I_F=20mA$		TYP.	15	15	15	nm
Half Intensity Angle	$I_F=20mA$	2 1/2	TYP.	160	160	160	deg.

**Luminous Intensity Rank ( Unit : mcd)**

(Ta=25 )

Intensity Tolerance each Rank : +/- 10%

ランク	I <sub>v</sub> (mcd)					
	NUY		NUA		NUR	
	I <sub>F</sub> =20mA		I <sub>F</sub> =20mA		I <sub>F</sub> =20mA	
	MIN.	MAX.	MIN.	MAX.	MIN.	MAX.
BA	/		/		/	
BB						
BC						
BD						
BE						
BF					68	100
CA	100	150			100	150
CB	150	220	150	220	150	220
CC	220	330	220	330	220	330
CD	330	470	330	470	330	470
CE	470	680	470	680	/	

Please contact our sales staff concerning rank designation.

**Color Tone Groups ( d)**

(Ta=25 )

Tolerance: +/- 2nm

ランク	Dominant Wavelength d(nm)					
	NUY		NUA		NUR	
	I <sub>F</sub> =20mA		I <sub>F</sub> =20mA		I <sub>F</sub> =20mA	
	MIN.	MAX.	MIN.	MAX.	MIN.	MAX.
A	580	586	597	603	620	626
B	586	592	603	609	626	632
C	592	598	609	615	/	

Please contact our sales staff concerning rank designation.

## Technical Data

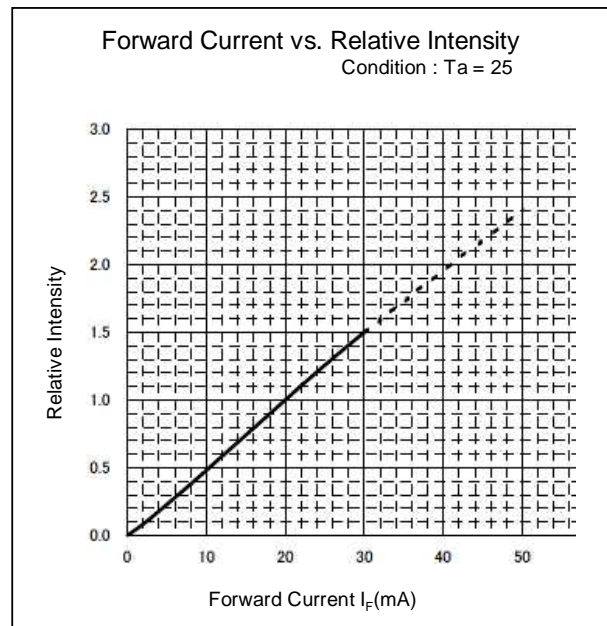
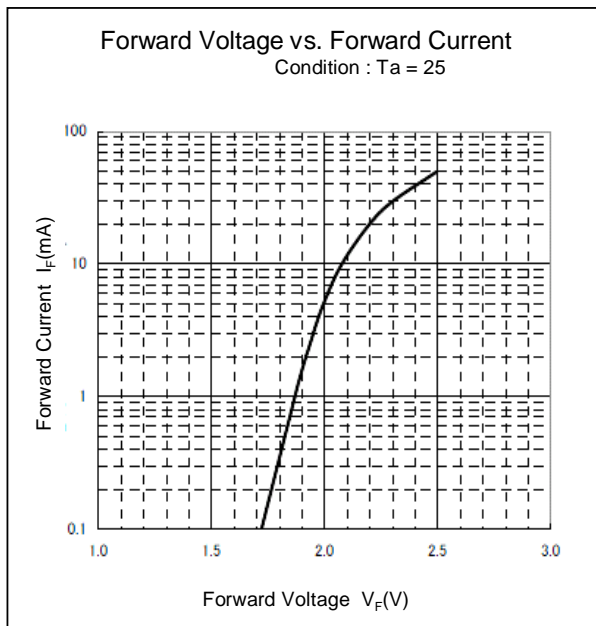
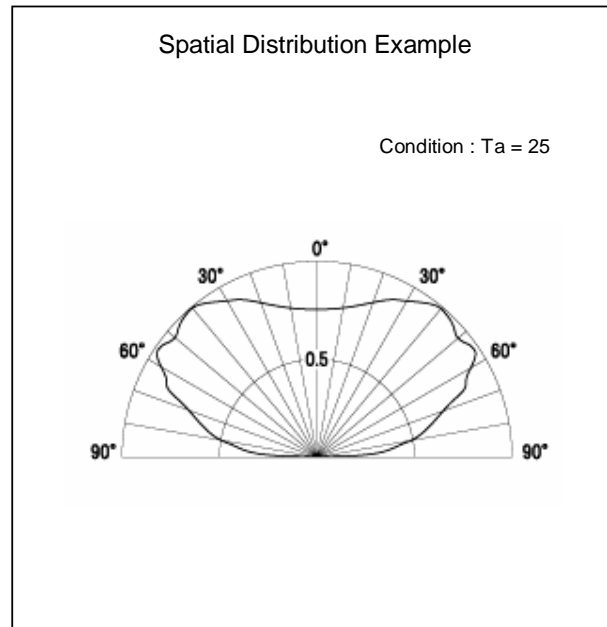
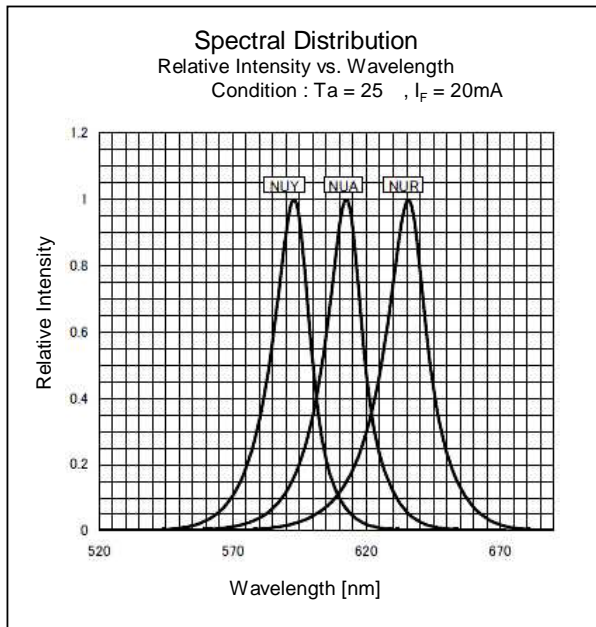

## Technical Data

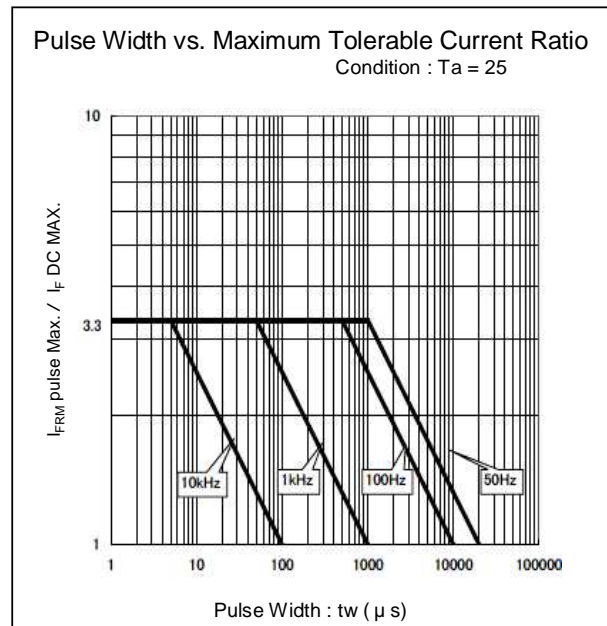
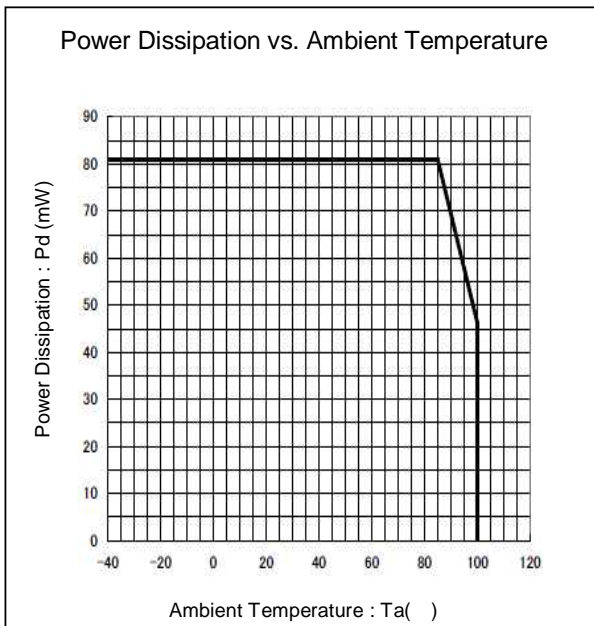
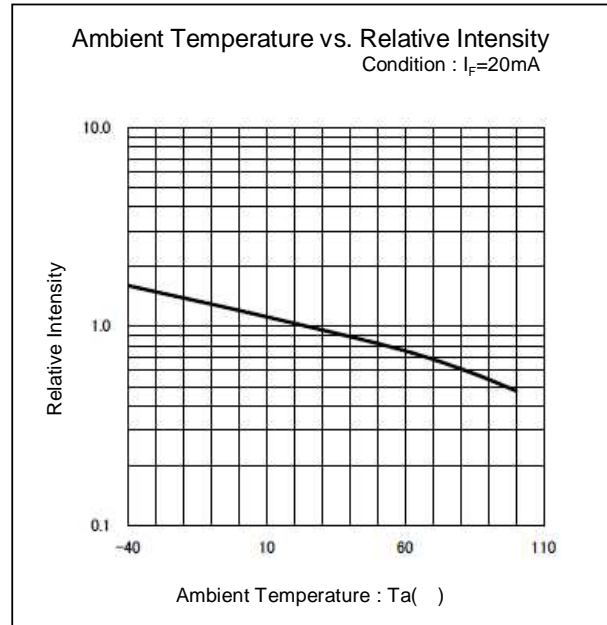
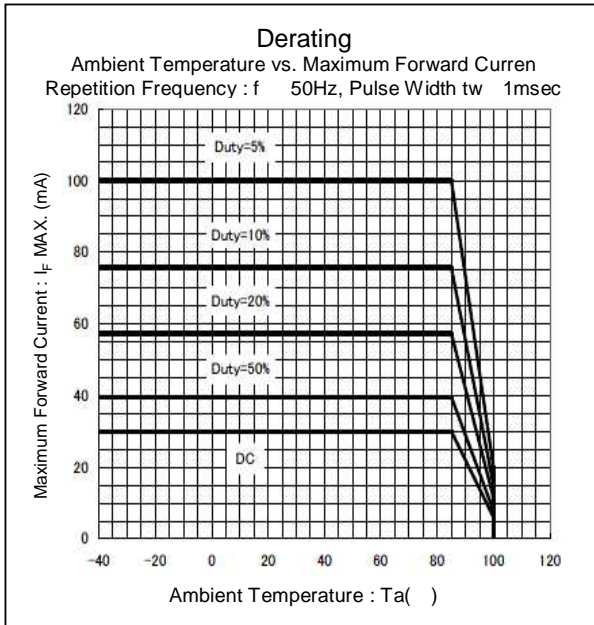

## Technical Data

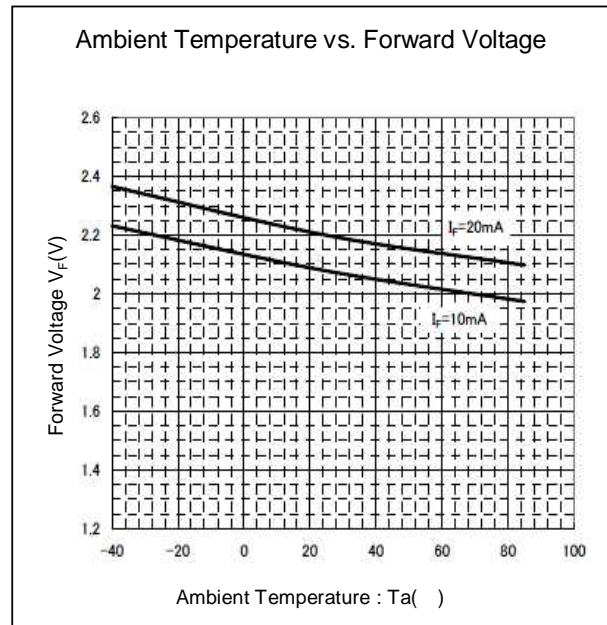
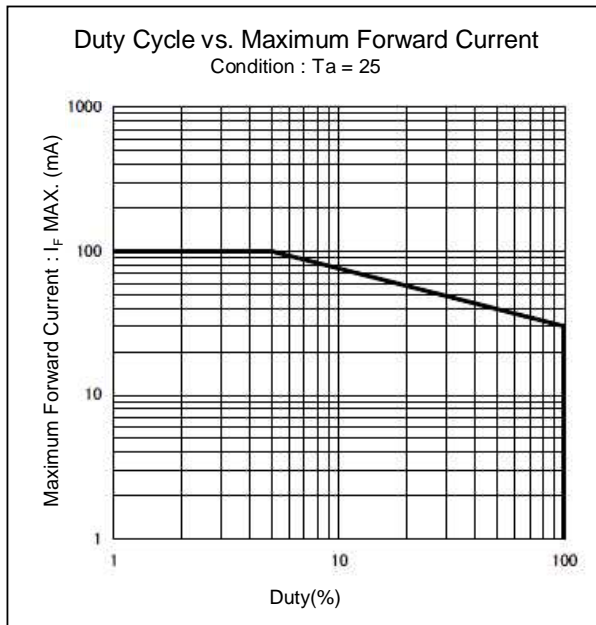

## Package Dimensions

(Unit: mm)

Weight: (8.0)mg

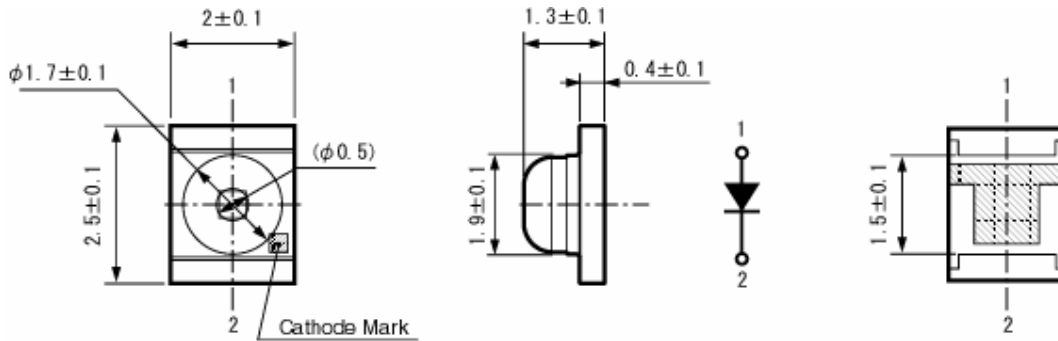

## Recommended Soldering Pattern

(Unit: mm)

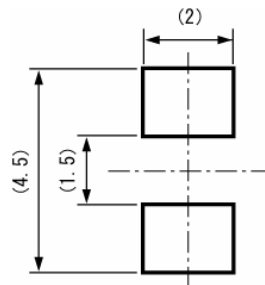

## Taping Specification

(Unit: mm)

Quantity : 2,500pcs/ reel (standard)

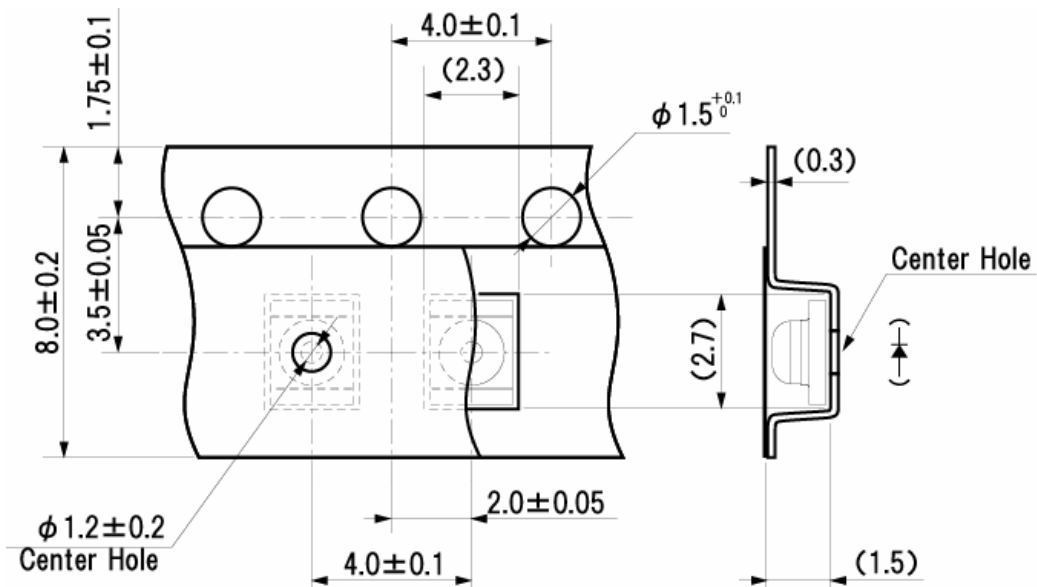



## Reflow Soldering Conditions

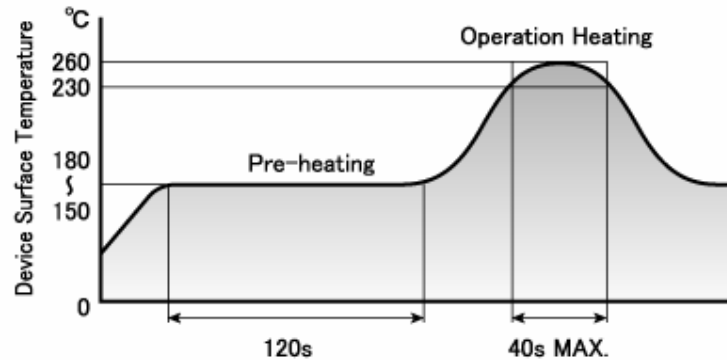

- 1) The above profile temperature gives the maximum temperature of the LED resin surface. Please set the temperature so as to avoid exceeding this range.
- 2) Total times of reflow soldering process shall be no more than 2 times. When the second reflow soldering process is performed, intervals between the first and second reflow should be short as possible (while allowing some time for the component to return to normal temperature after the first reflow) in order to prevent the LED from absorbing moisture.
- 3) Temperature fluctuation to the LED during the pre-heating process shall be minimized. (6 maximum)

## Manual Soldering Conditions

Iron tip temp.	350	(MAX.)
Soldering time and frequency	3 s	(MAX.)
	1 time	(MAX.)

## Reliability Testing Result

Reliability Testing Result	Applicable Standard	Testing Conditions	Duration	Failure
Room Temp. Operating Life	EIAJ ED-4701/100(101)	Ta = 25 , If = Maximum Rated Current	1,000 h	0/25
Resistance to Soldering Heat	EIAJ ED-4701/300(301)	Pre-heating : 150 ~ 180 120s Max. Operation Heating : 230 40s Max. Peak Temperature : 260	Twice	0/25
Temperature Cycling	EIAJ ED-4701/100(105)	Minimum Rated Storage Temperature(30min) ~ Normal Temperature(15min) ~ Maximum Rated Storage Temperature(30min) ~ Normal Temperature(15min)	200 cycles	0/25
High Temp. Operating Life	EIAJ ED-4701/100(101)	Ta = 100 , If = 15mA	1,000 h	0/25
Humidity Temp. Operating Life	EIAJ ED-4701/100(102)	Ta = 60±2 , RH = 90±5%, If = Maximum Rated Current	1,000 h	0/25
High Temp. Storage Life	EIAJ ED-4701/200(201)	Ta = Maximum Rated Storage Temperature	1,000 h	0/25
Low Temp. Storage Life	EIAJ ED-4701/200(202)	Ta = Minimum Rated Storage Temperature	1,000 h	0/25
Vibration, Variable Frequency	EIAJ ED-4701/400(403)	98.1m/s <sup>2</sup> (10G), 100 ~ 2KHz sweep for 20min., XYZ each direction	2 h	0/10

## Failure Criteria

Items	Symbols	Conditions	Failure criteria
Luminous Intensity	Iv	If Value of each product Luminous Intensity	Testing Min. Value < Spec. Min. Value x 0.5
Forward Voltage	V <sub>F</sub>	If Value of each product Forward Voltage	Testing Max. Value > Spec. Max. Value x 1.2
Reverse Current	I <sub>R</sub>	V <sub>R</sub> = Maximum Rated Reverse Voltage V	Testing Max. Value > Spec. Max. Value x 2.5
Cosmetic Appearance	-	-	Occurrence of notable decoloration, deformation and cracking

## Special Notice to Customers Using the Products and Technical Information Shown in This Data Sheet

- 1) The technical information shown in the data sheets are limited to the typical characteristics and circuit examples of the referenced products. It does not constitute the warranting of industrial property nor the granting of any license.
- 2) For the purpose of product improvement, the specifications, characteristics and technical data described in the data sheets are subject to change without prior notice. Therefore it is recommended that the most updated specifications be used in your design.
- 3) When using the products described in the data sheets, please adhere to the maximum ratings for operating voltage, heat dissipation characteristics, and other precautions for use. We are not responsible for any damage which may occur if these specifications are exceeded.
- 4) The products that have been described to this catalog are manufactured so that they will be used for the electrical instrument of the benchmark (OA equipment, telecommunications equipment, AV machine, home appliance and measuring instrument).  
The application of aircrafts, space borne application, transportation equipment, medical equipment and nuclear power control equipment, etc. needs a high reliability and safety, and the breakdown and the operation might influence the life or the human body. Please consult us beforehand if you plan to use our product for the usages of aircrafts, space borne application, transportation equipment, medical equipment and nuclear power control equipment, etc. except OA equipment, telecommunications equipment, AV machine, home appliance and measuring instrument.
- 5) In order to export the products or technologies described in this data sheet which are under the "Foreign Exchange and Foreign Trade Control Law," it is necessary to first obtain an export permit from the Japanese government.
- 6) No part of this data sheet may be reprinted or reproduced without prior written permission from Stanley Electric Co., Ltd.
- 7) The most updated edition of this data sheet can be obtained from the address below:  
<http://www.stanley-components.com>