



GENERAL DESCRIPTION

SM5272B is a remote control decoder paired with SM5262B utilizing CMOS Technology. It has 12-bit tri-state address pins providing a maximum of 531,411 (or 3¹²) address codes; thereby, drastically reducing any code collision and unauthorized code scanning possibilities. SM5272B is available in several options to suit every application needs : variable number of data output pins, latch or momentary output type.

FEATURES

- * CMOS Technology
- * Low power consumption
- * Very high noise immunity
- * Up to 12 tri-State code address pins
- * Up to 6 data pins
- * Wide range of operating voltage:
V_{cc}= 2.5 ~ 9 Volts
- * Single resistor oscillator
- * Latch or momentary output type
- * Available in DIP and SOP package

APPLICATIONS

- * Garage door
- * Toys
- * Remote control for industrial use

BLOCK DIAGRAM

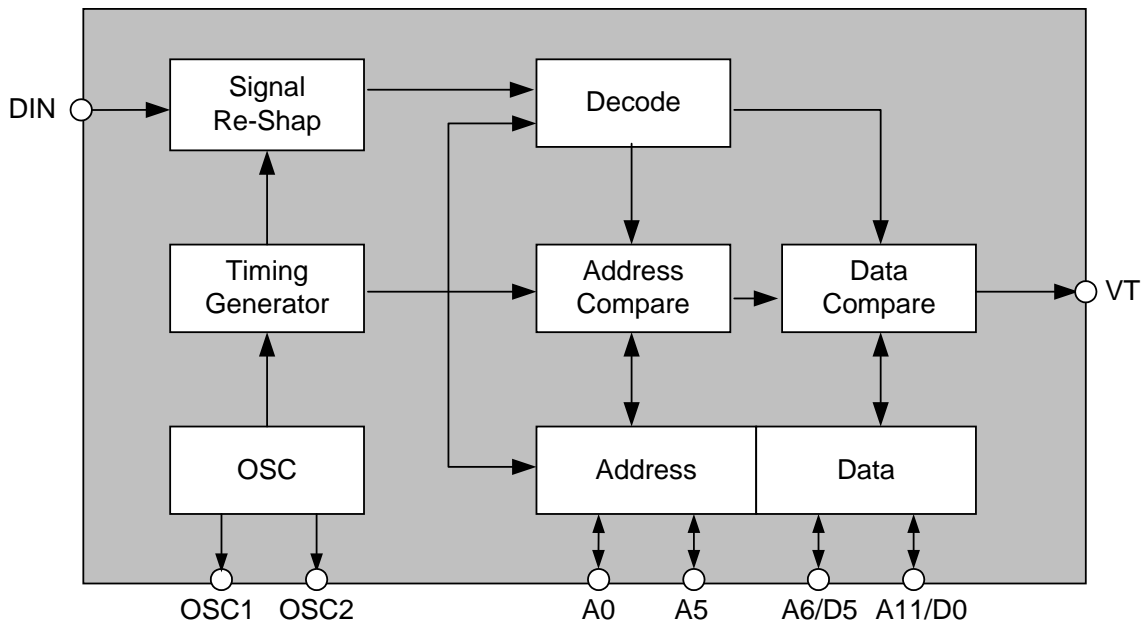



PIN ASSIGNMENTS (DIP)

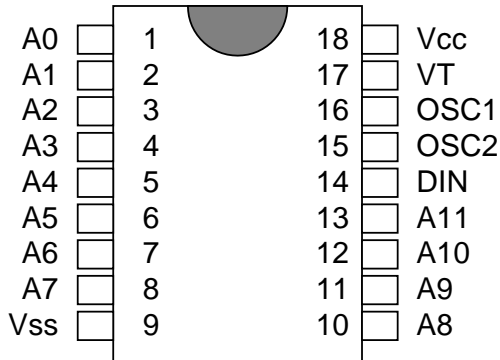

SM5272B

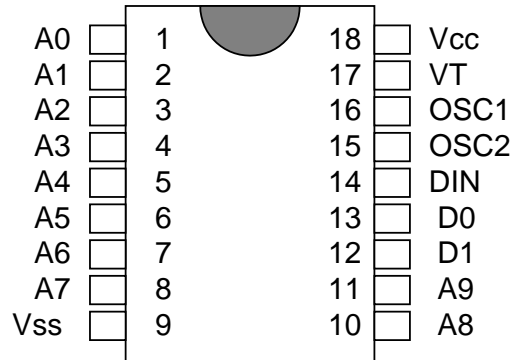

SM5272B-M2/L2

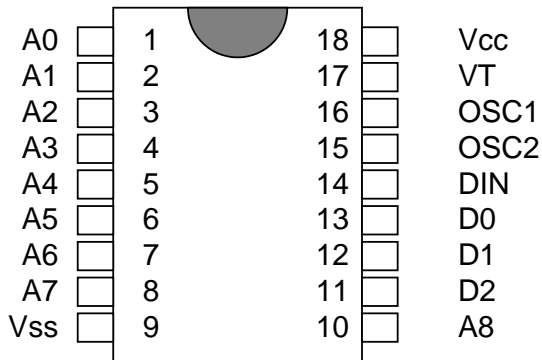

SM5272B-M3/L3

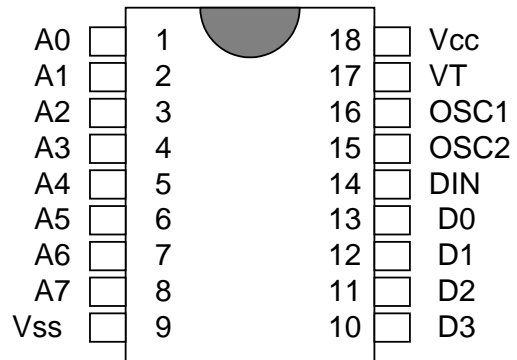

SM5272B-M4/L4

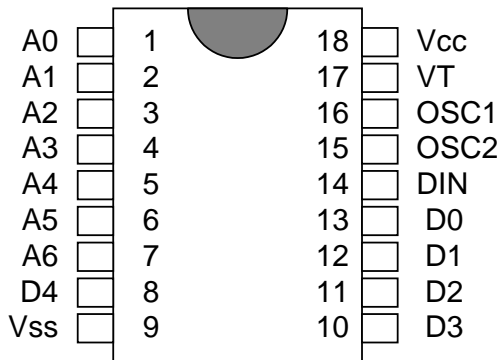

SM5272B-M5/L5

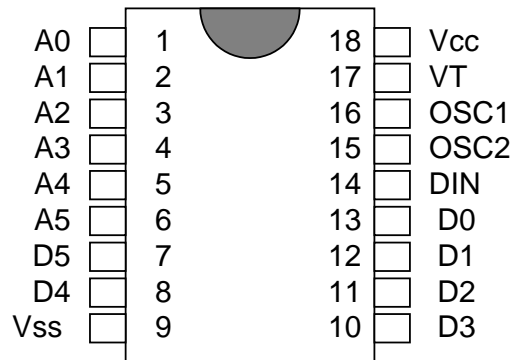

SM5272BM6/L6



PIN CONFIGURATION (SOP)

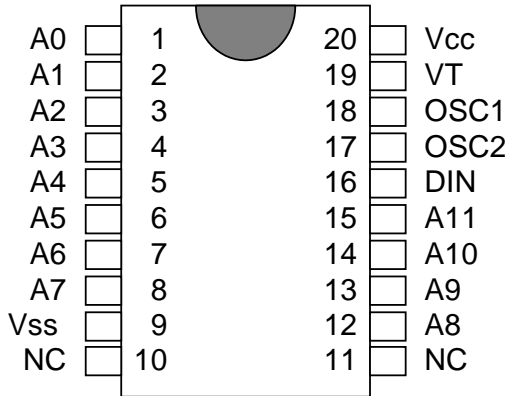

SM5272BS

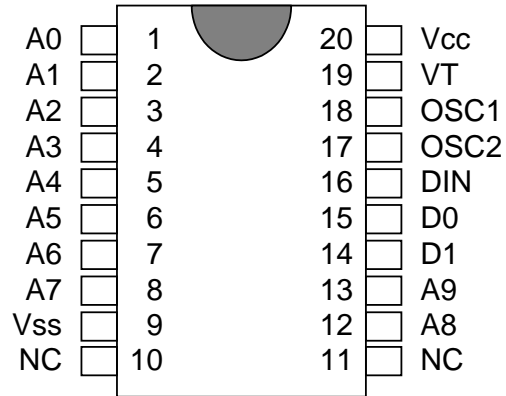

SM5272BS-M2/L2

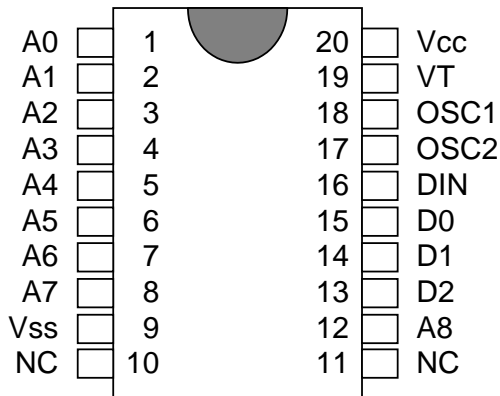

SM5272BS-M3/L3

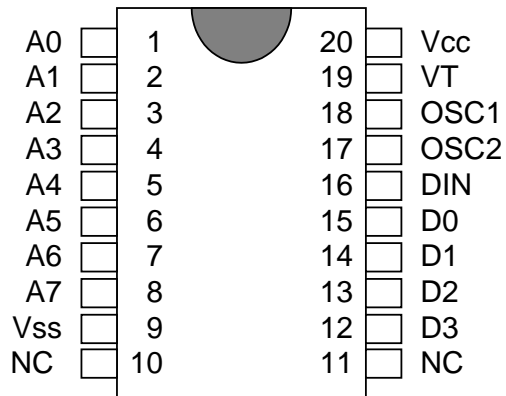

SM5272BS-M4/L4

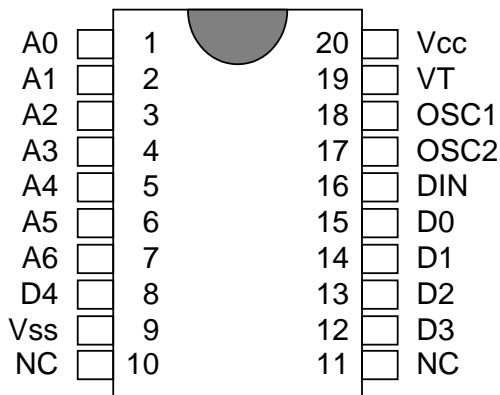

SM5272BS-M5/L5

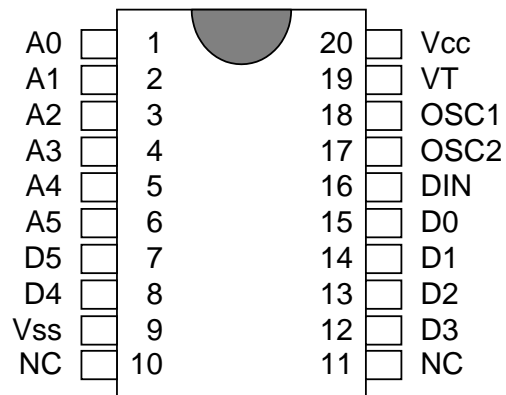

SM5272BS-M6/L6



PIN FUNCTION

No.	Pin Name	I/O	Function
1	A0	I	Address input, each pin can be set to "0", "1", or floating.
2	A1	I	
3	A2	I	
4	A3	I	
5	A4	I	
6	A5	I	
7	A6/D5	I / O	Address input or data output.
8	A7/D4	I / O	
9	Vss	POWER	Negative power supply.
10	A8/D3	I / O	Address input or data output.
11	A9/D2	I / O	
12	A10/D1	I / O	
13	A11/D0	I / O	
14	DIN	I	Receive from Rf module.
15	OSC1	I	Resistor connected between these two pins determine the system clock.
16	OSC2	O	
17	VT	O	Valid transmission indication.
18	VDD	POWER	Positive power supply.



Code Word

A group of Code Bits is called a code Word. A Code Word consists of 12 Address plus Data bits followed by one Sync Bit. The 12 AD bits are interpreted as either address or data bits depending on the SM5272B version used. Please refer to the diagrams below:

SM5272B



SM5272B-M2/L2



SM5272B-M3/L3



SM5272B-M4/L4



SM5272B-M5/L5



SM5272B-M6/L6

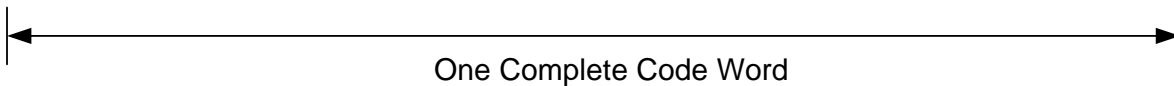



Valid Transmission

After Power On SM5272B enters the Search Address mode, if SM5272B finds 2 consecutive Address that matches the Address Pin setting of SM5272B then it will set VT high.

If VT is set high, SM5272B is still in search Address. After 2 consecutive Address that do not match the setting on SM5272B, SM5272B will disable VT.

The timing are shown in the following diagram.

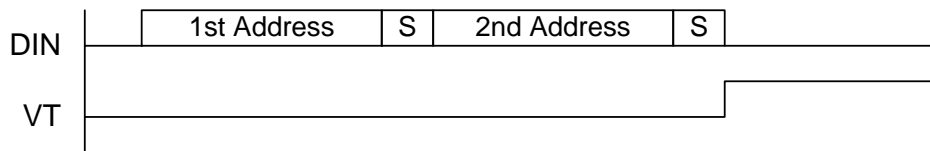

Latch or Momentary Data Output Type

After Power On SM5272B is set in Address search mode, if SM5272B finds 2 consecutive Address that matches the Address setting of SM5272B. SM5272B will enter Data Compare mode. It will compare perviously 2 receive data, if they match each then SM5272B will set VT high and send data O/P.

SM5272B re-enters Address search mode, after 2 consecutive Address that do not match the setting on SM5272B will disable VT and momentary's data but keep Latch's data intact.

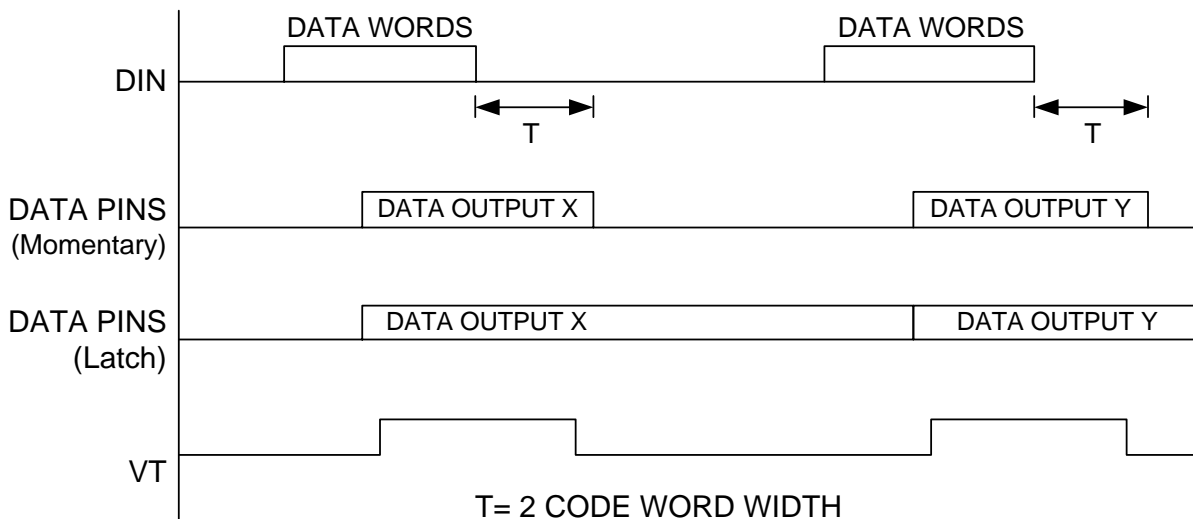



OPERATION FLOWCHART

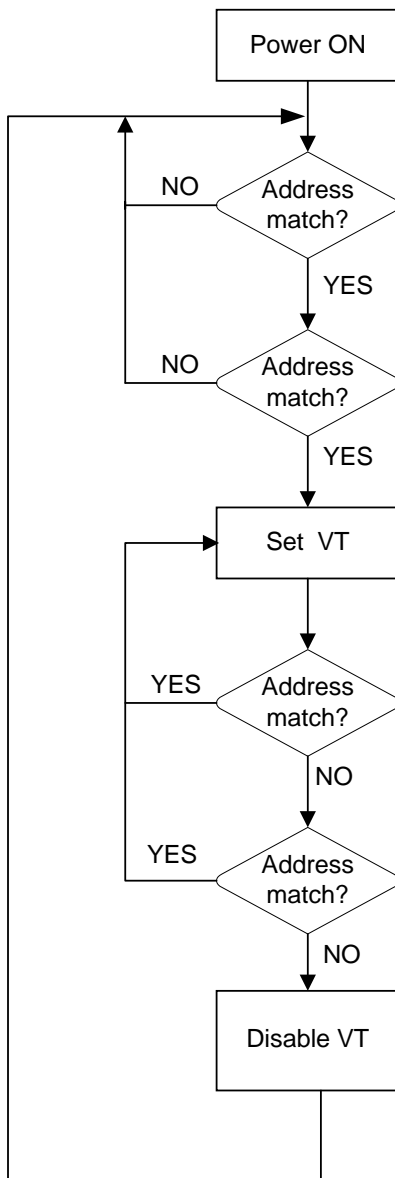

After Power On SM5272B enters the Search Address mode, if SM5272B finds 2 consecutive Address that matches the Address Pin setting of SM5272B, it will set VT high.

If VT is set high, SM5272B is still in search Address. After 2 consecutive Address that do not match the setting on SM5272B, SM5272B will disable VT.



DECODER WITH DATA OUTPUT PINS

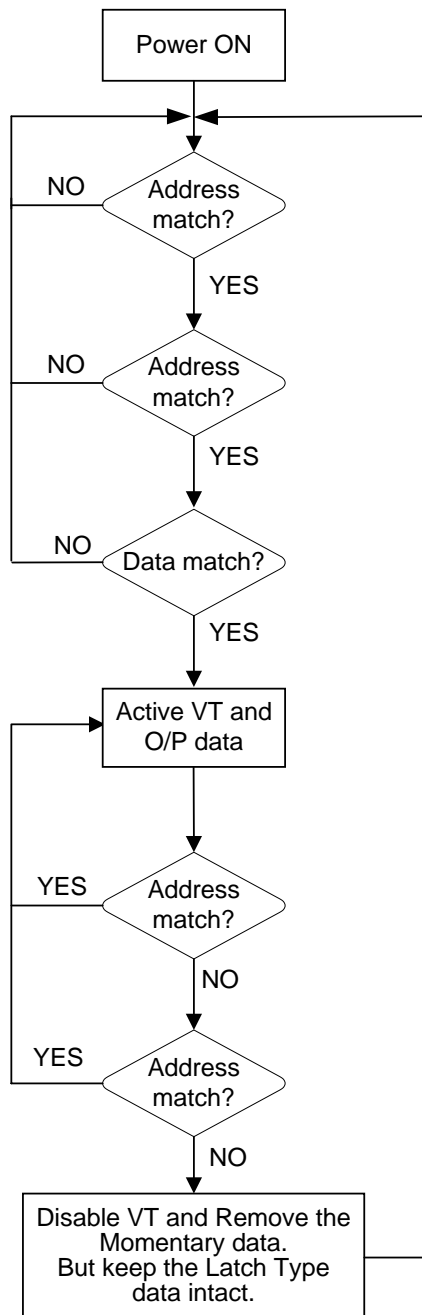

After Power On SM5272B is set in Address search mode, if SM5272B finds 2 consecutive Address that matches the Address setting of SM5272B.

SM5272B will enter Data Compare mod. It will compare previously 2 received data, if they match then SM5272B will set VT high and send data O/P.

SM5272B re-enters Address search mode, after 2 consecutive Address that do not match setting on SM5272B will disable VT and momentary's data but keep Latch's data intact.



Single Resistor Oscillator

SM5272B's oscillator be constructed by connecting a resistor between OSC1 and OSC2 pin.
SM5272B's OSC frequency must be 1.4 to 6.8 times more than SM5262B.

Encoder OSC Frequency

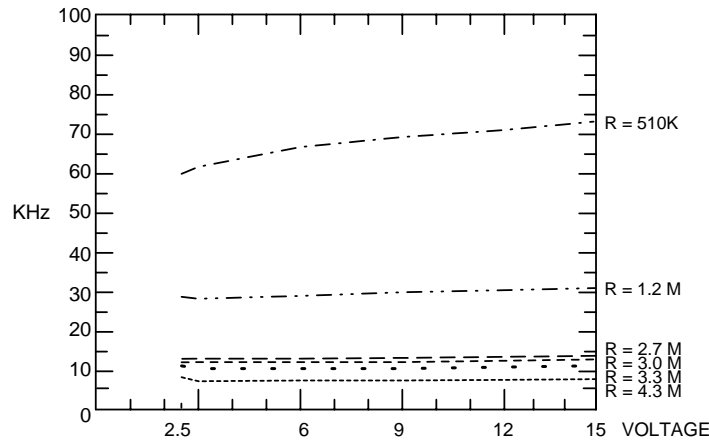

Decoder OSC Frequency

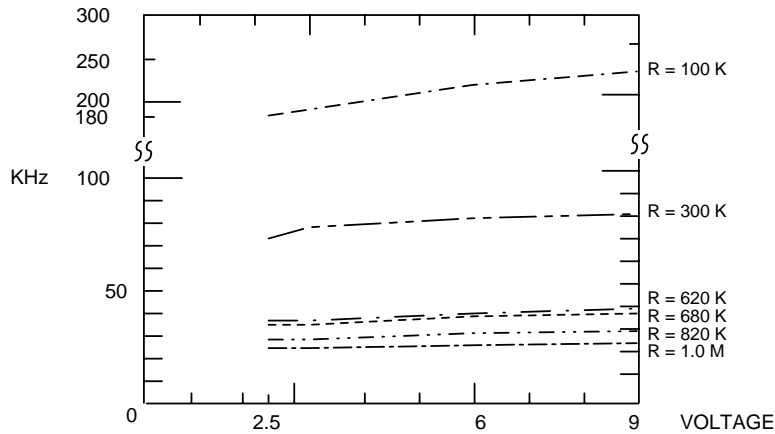

Suggested oscillator resistor of SM5262B/ SM5272B:

SM5262B	SM5272B
4.7M OHM	750K OHM
3.0M OHM	390K OHM
2.2M OHM	270K OHM
1.2M OHM	160K OHM



DC ELECTRICAL CHARACTERISTICS

Parameter	Symbol	Conditions	Limit			Unit
			Min.	Typ.	Max.	
Supply Voltage	VCC		2.5		9	V
Standby Current	ISTB	VCC = 12 V OSC stop A0 ~ A11 open		0.02	0.3	μA
Data Output Driving Current	IOH	VCC = 5V VOH = 4V	-3.5			mA
		VCC = 9V VOH = 7.2V	-7.1			mA
Data Output Sinking Current	IOL	VCC = 5V VOH = 1V	8			mA
		VCC = 9V VOH = 1.8V	20			mA



APPLICATION CIRCUIT

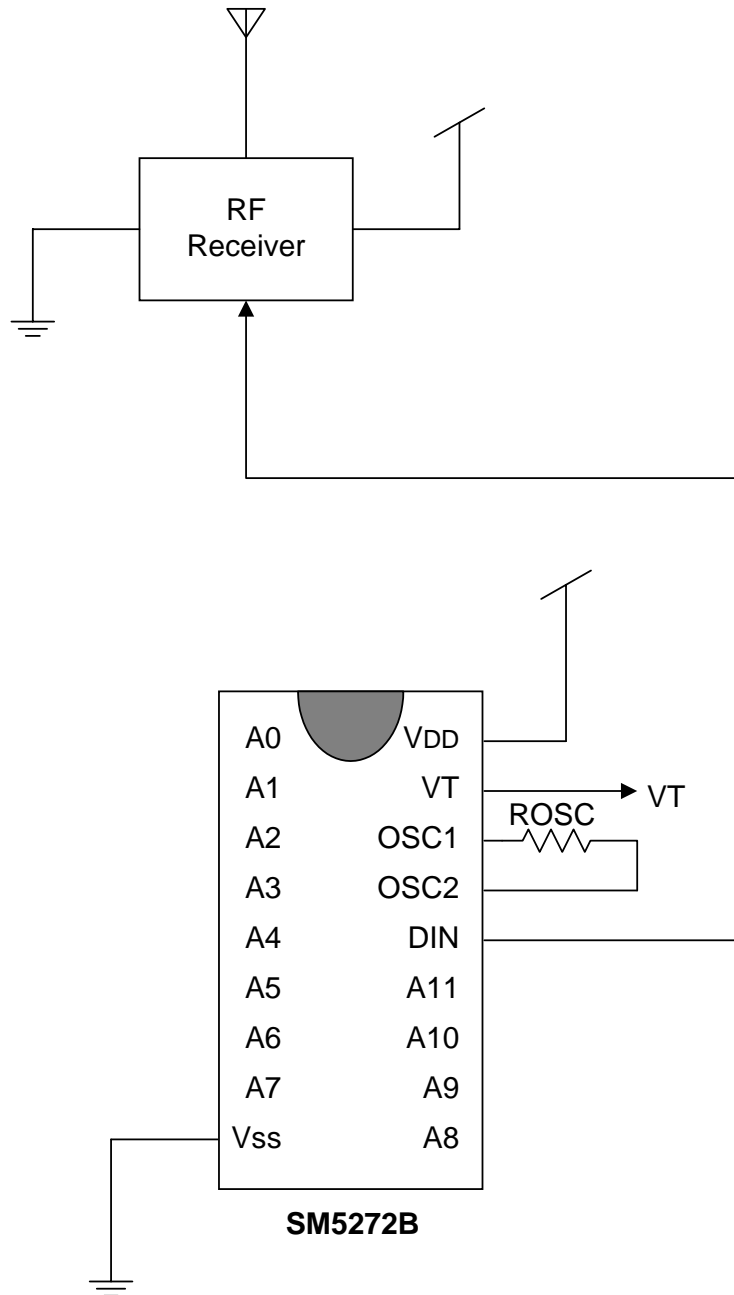



ORDERING INFORMATION

Part No.	Package
SM5272B	18 Pin DIP

Part No.	Package
SM5272BS	20 Pin SOP

