



SANYO Semiconductors

DATA SHEET

LA1225M — Monolithic Linear IC FM IF Detector IC

Overview

The LA1225M is a Low-voltage operation (1.8V or higher) FM IF detector IC for the electronic tuning system.

Features

- Low-voltage operation (1.8V or higher)
- Supports electronic tuning systems (provides built-in SD output and IF count output functions)
- FM detector circuit accepts an even wider input frequency range. (Supports the use of an external phase capacitor.)
- Miniature package: MFP-10S

Functions

- IF amplifier
- Quadrature detector
- Signal meter
- SD
- IF buffer

Specifications

Maximum Ratings at Ta = 25°C

Parameter	Symbol	Conditions	Ratings	Unit
Maximum supply voltage	V _{CC} max		9.0	V
Allowable power dissipation	Pd max	Ta ≤ 85°C	100	mW
Operating temperature	Topr		-20 to +85	°C
Storage temperature	Tstg		-55 to +150	°C

Operating Conditions at Ta = 25°C

Parameter	Symbol	Conditions	Ratings	Unit
Recommended supply voltage	V _{CC}		3.0	V
Operating supply voltage range	V _{CC} op		1.8 to 8.0	V

■ Any and all SANYO Semiconductor products described or contained herein do not have specifications that can handle applications that require extremely high levels of reliability, such as life-support systems, aircraft's control systems, or other applications whose failure can be reasonably expected to result in serious physical and/or material damage. Consult with your SANYO Semiconductor representative nearest you before using any SANYO Semiconductor products described or contained herein in such applications.

■ SANYO Semiconductor assumes no responsibility for equipment failures that result from using products at values that exceed, even momentarily, rated values (such as maximum ratings, operating condition ranges, or other parameters) listed in products specifications of any and all SANYO Semiconductor products described or contained herein.

SANYO Semiconductor Co., Ltd.

TOKYO OFFICE Tokyo Bldg., 1-10, 1 Chome, Ueno, Taito-ku, TOKYO, 110-8534 JAPAN

LA1225M

Operating Characteristics at $T_a = 25^\circ\text{C}$, $V_{CC} = 3.0\text{V}$, $f_C = 10.7\text{MHz}$

Parameter	Symbol	Conditions	Ratings			Unit
			min	typ	max	
Current drain	I_{CCO}	No input	3.0	4.0	5.0	mA
Demodulator output	V_O	100dB μ , 100% mod., $f_m = 1\text{kHz}$	70	150	220	mV
Total harmonic distortion	THD	100dB μ , 100% mod., $f_m = 1\text{kHz}$		0.5	0.8	%
Signal-to-noise ratio	S/N	100dB μ , 100% mod., $f_m = 1\text{kHz}$	65	73		dB
3dB sensitivity	-3dBL.S	100dB μ , 100% mod., $f_m = 1\text{kHz}$ output reference, when the input is -3dB	19	28	37	dB μ
SD sensitivity	SDON	0% mod.	35	50	65	dB μ
IF counter buffer output	V_{IFBuff}	100dB μ	90	130	170	mV

Package Dimensions

unit : mm

3086B

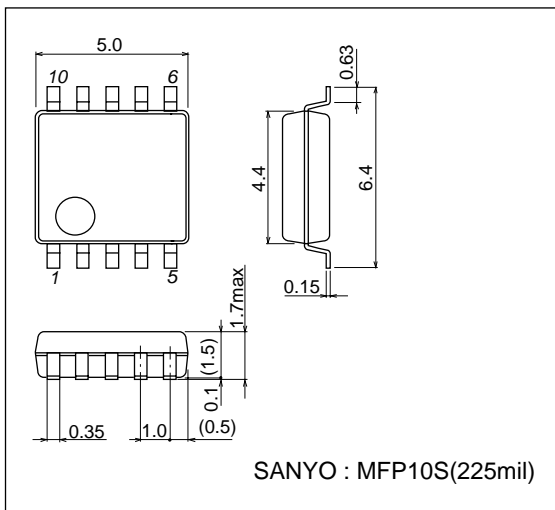

LA1225M

Block Diagram and Test Circuit

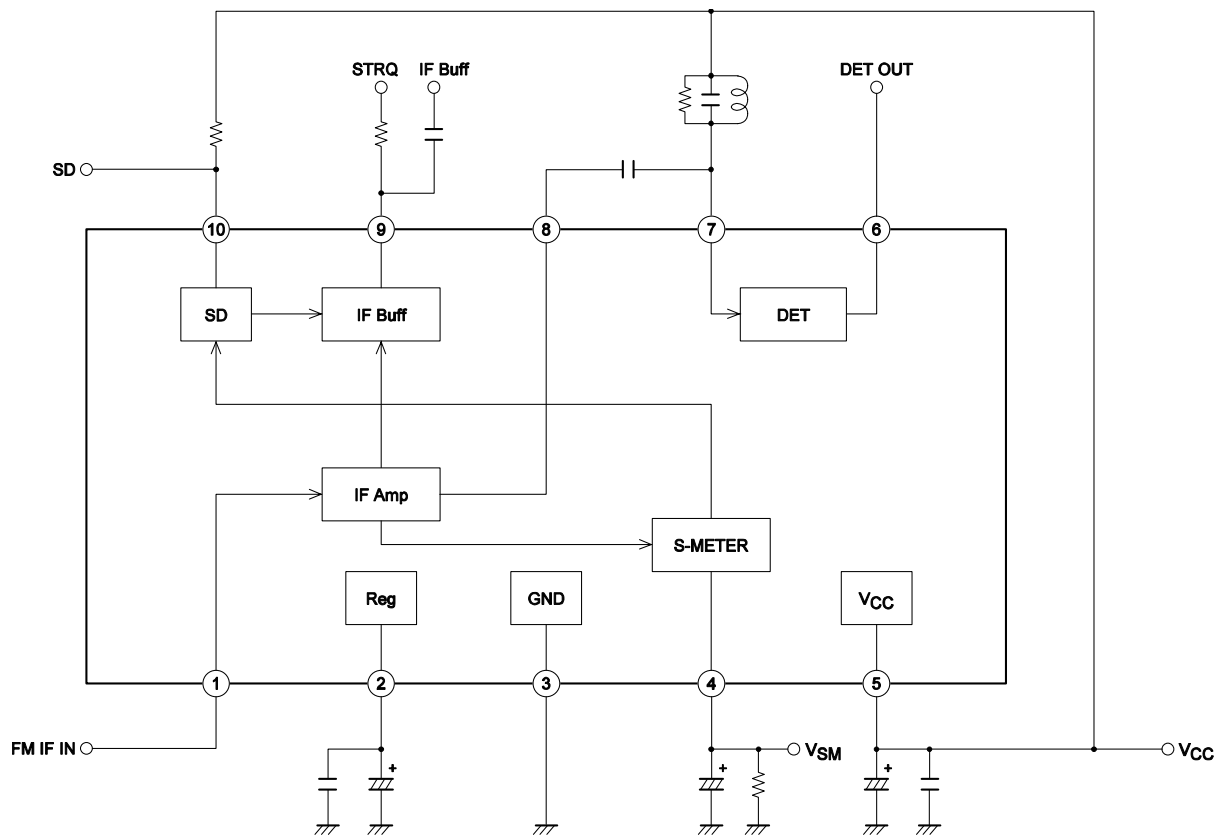

A11614

Sample Application Circuit

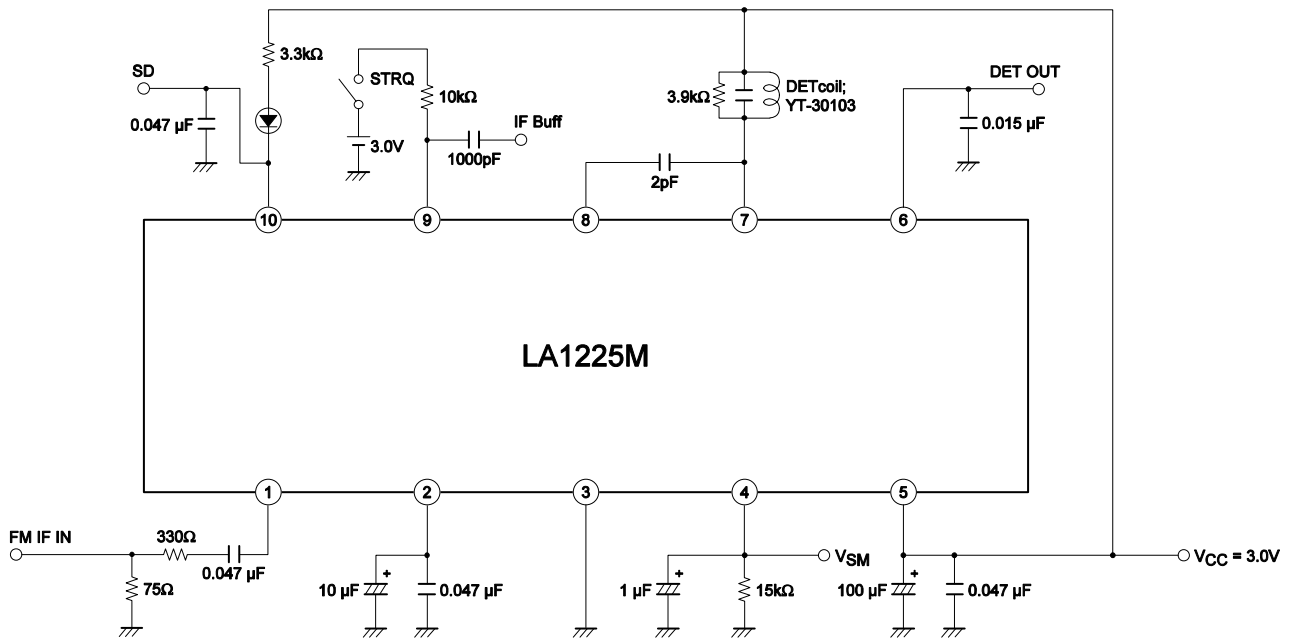

A11615

LA1225M

Pin Functions No-Signal Voltage at V_{CC} = 3.0V

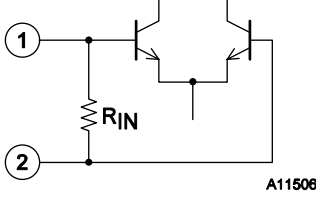
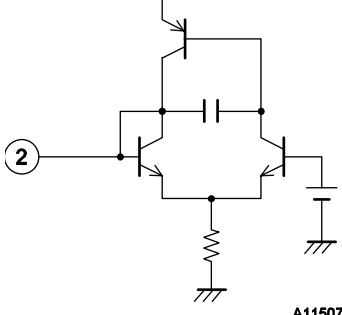
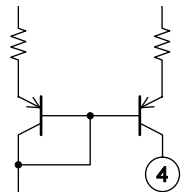
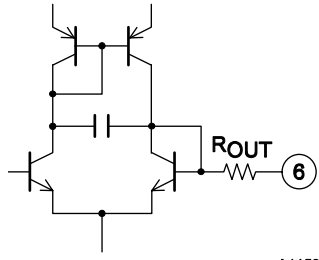
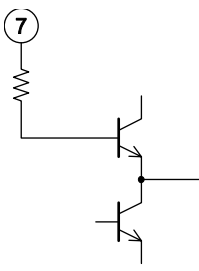
Pin No.	Function	No-signal voltage (V)	Equivalent circuit	Notes
1	IF input	1.2	 <p style="text-align: right;">A11506</p>	Input impedance $R_{IN} = 330\Omega$
2	Reg	1.2	 <p style="text-align: right;">A11507</p>	$V_{reg} = 1.2V$
3	GND	0		
4	S-meter output	0.1	 <p style="text-align: right;">A11508</p>	Open collector output. The SD sensitivity can be adjusted with an external resistor connected to this pin.
5	V _{CC}	3.0		
6	Demodulated output	1.5	 <p style="text-align: right;">A11509</p>	Output impedance $R_{OUT} = 3k\Omega$
7	DET	3.0	 <p style="text-align: right;">A11510</p>	The detector coil is inserted between pin 7 and pin 5 (V _{CC}).

Continued on next page.

LA1225M

Continued from preceding page.

Pin No.	Function	No-signal voltage (V)	Equivalent circuit	Notes
8	Limiter amplifier output	2.8	<p style="text-align: right;">A11511</p>	Pin 8 and pin 7 (DET) are connected through a capacitor.
9	IF buffer (Also used for control SW)	0	<p style="text-align: right;">A11512</p>	The IF buffer output is turned on when the voltage applied to the pin is the recommended 1.5V or higher.
10	SD	1.6	<p style="text-align: right;">A11513</p>	This is an active-low output. This is an open-collector output and can directly drive an LED. ($I_{Cmax} = 20mA$)

I/O Characteristics

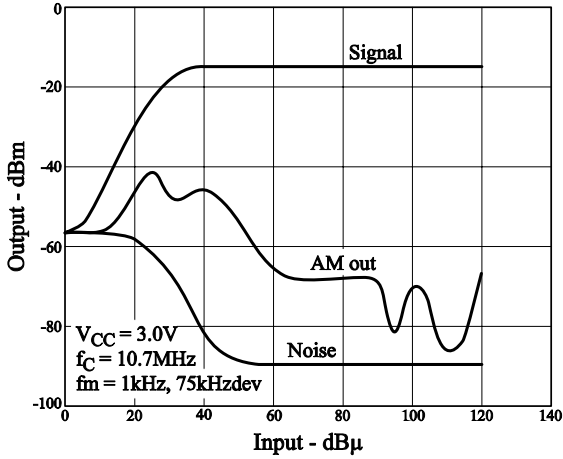

I/O Characteristics

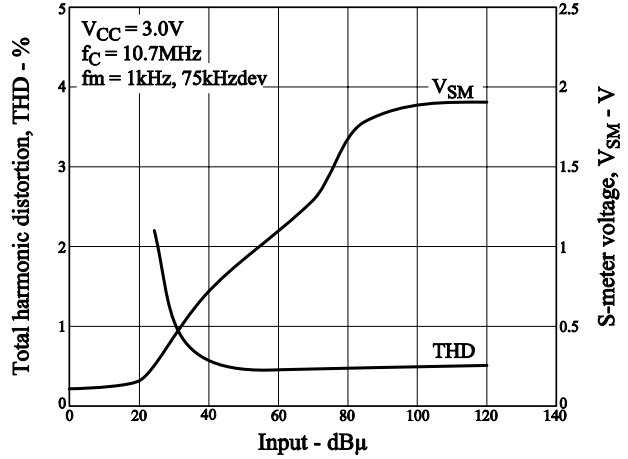

VO - VCC

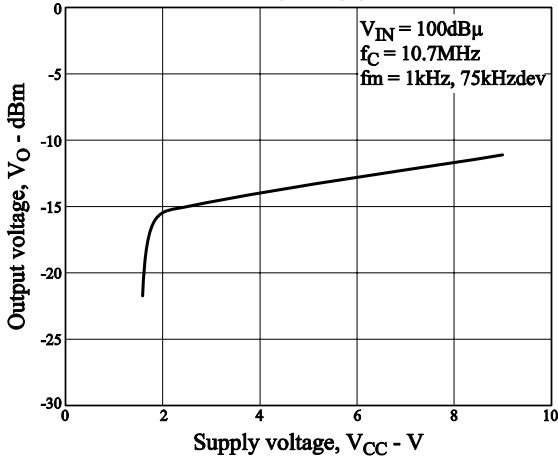

S/N - VCC

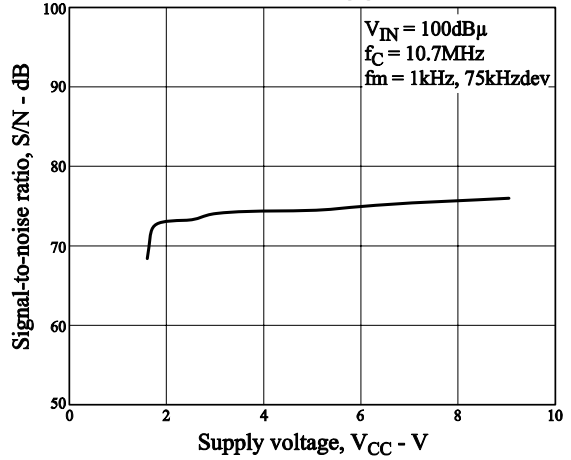

THD - VCC

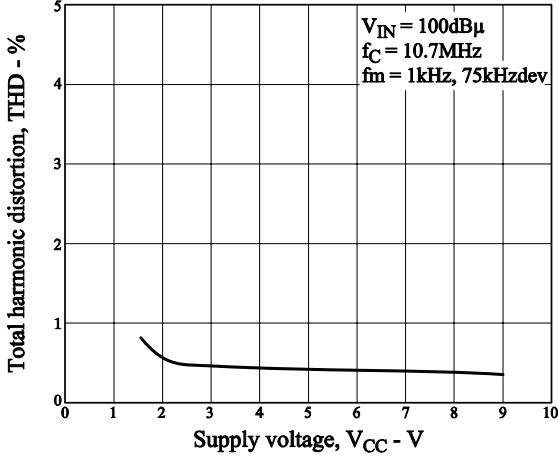

-3dBLS, QS - VCC

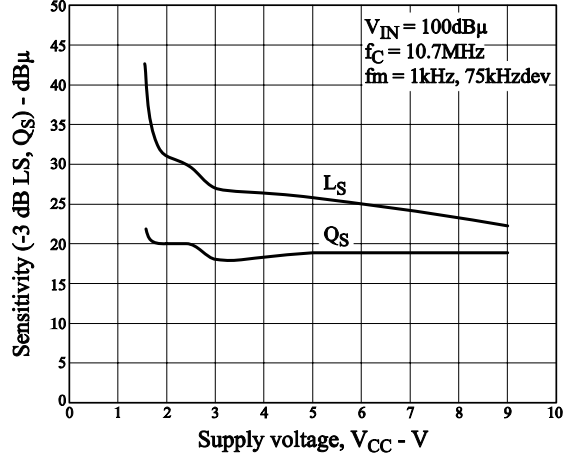

SDON - VCC

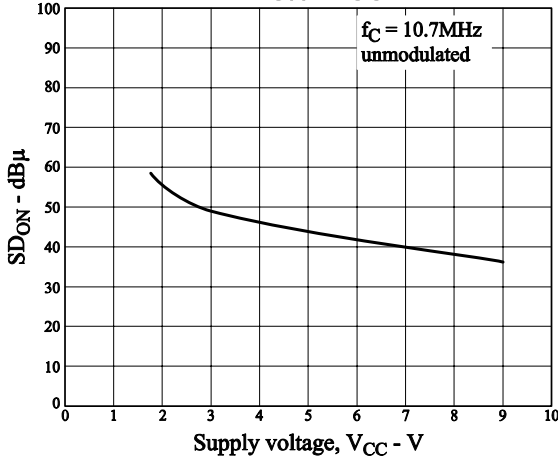

VIFBuff - VCC

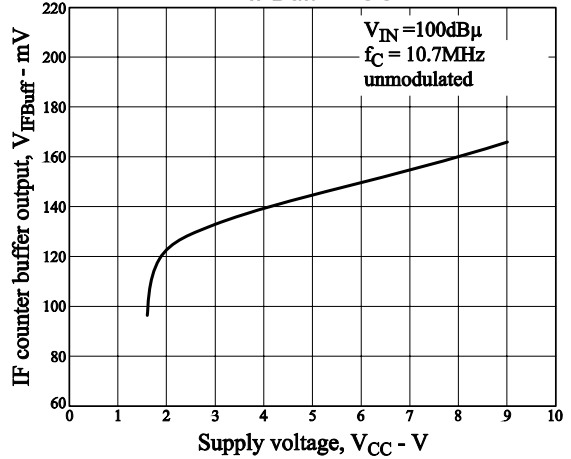

LA1225M

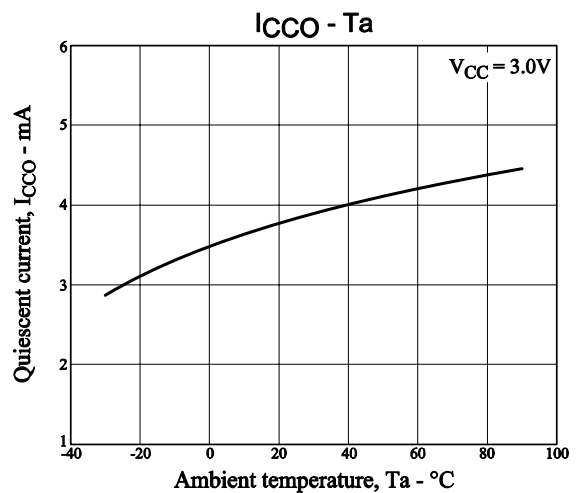
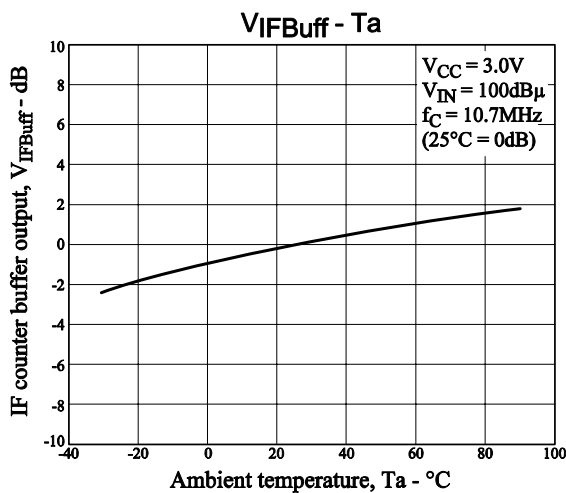
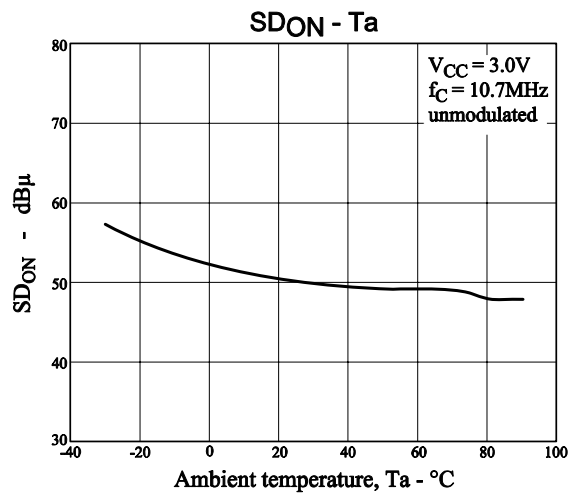
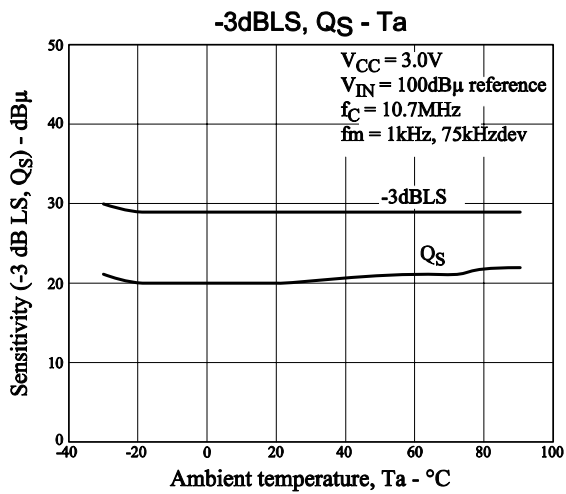
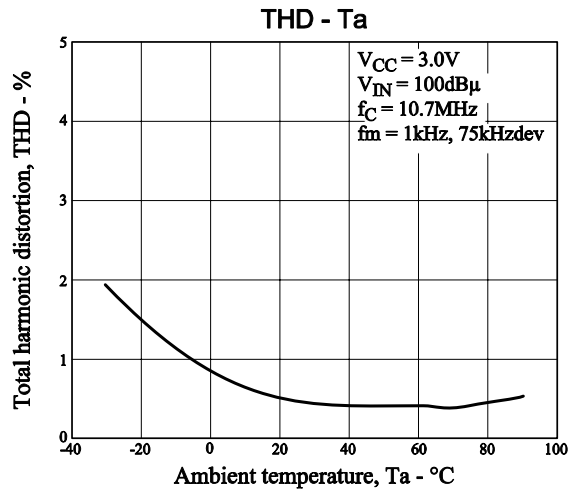
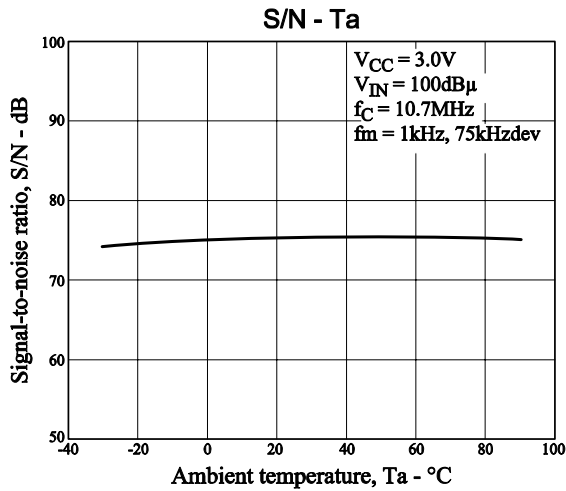
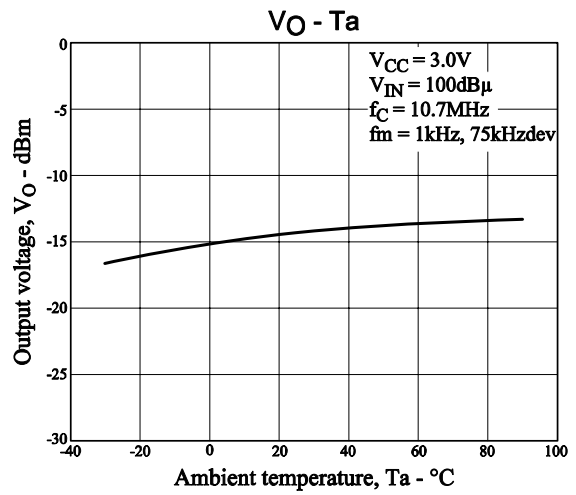
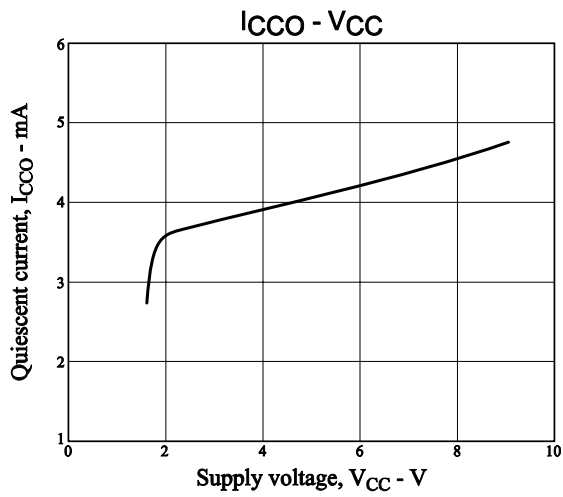

- Specifications of any and all SANYO Semiconductor products described or contained herein stipulate the performance, characteristics, and functions of the described products in the independent state, and are not guarantees of the performance, characteristics, and functions of the described products as mounted in the customer's products or equipment. To verify symptoms and states that cannot be evaluated in an independent device, the customer should always evaluate and test devices mounted in the customer's products or equipment.
- SANYO Semiconductor Co., Ltd. strives to supply high-quality high-reliability products. However, any and all semiconductor products fail with some probability. It is possible that these probabilistic failures could give rise to accidents or events that could endanger human lives, that could give rise to smoke or fire, or that could cause damage to other property. When designing equipment, adopt safety measures so that these kinds of accidents or events cannot occur. Such measures include but are not limited to protective circuits and error prevention circuits for safe design, redundant design, and structural design.
- In the event that any or all SANYO Semiconductor products (including technical data, services) described or contained herein are controlled under any of applicable local export control laws and regulations, such products must not be exported without obtaining the export license from the authorities concerned in accordance with the above law.
- No part of this publication may be reproduced or transmitted in any form or by any means, electronic or mechanical, including photocopying and recording, or any information storage or retrieval system, or otherwise, without the prior written permission of SANYO Semiconductor Co., Ltd.
- Any and all information described or contained herein are subject to change without notice due to product/technology improvement, etc. When designing equipment, refer to the "Delivery Specification" for the SANYO Semiconductor product that you intend to use.
- Information (including circuit diagrams and circuit parameters) herein is for example only; it is not guaranteed for volume production. SANYO Semiconductor believes information herein is accurate and reliable, but no guarantees are made or implied regarding its use or any infringements of intellectual property rights or other rights of third parties.

This catalog provides information as of April, 2006. Specifications and information herein are subject to change without notice.