

NEW

Substrate Twin (Pair) Cable Swing-Lock Connector for Low-Profile Power Source

DF57 Series

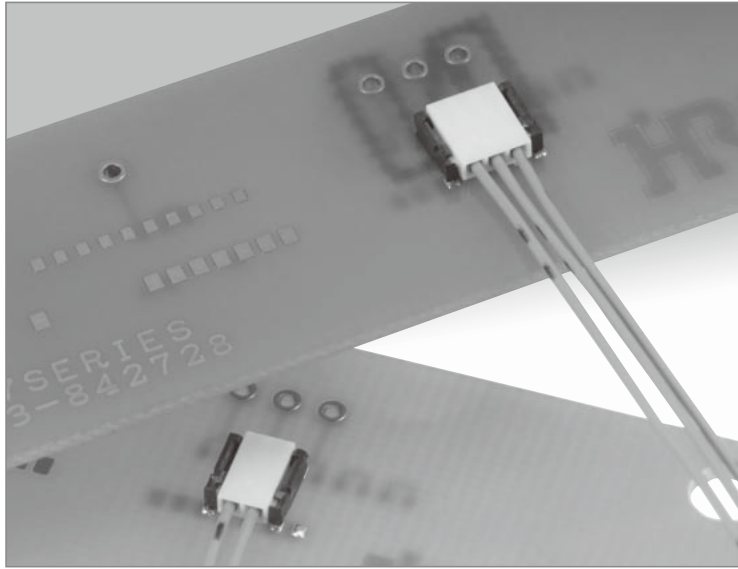

■ Features

1. Reinforced lock structure with swing lock

A swing-lock structure, featuring our own unique connection method, reinforces the lock structure of the electric cable side, with a structure resistant to tough electric cable routing and disengagement of cables under load.

In addition, the connection surface has a guide insertion to facilitate insertability (patent pending)

When connecting, the header connector secures the molded-lance. Play of molded lance is prevented for added strength.

3. Highly reliable contact structure

Despite the low-profile design, with a stacking height of 1.4mm, an effective mating length of 0.42mm is achieved. The structure features two-point contact terminal geometry with high contact reliability.

4. Solder wicking prevention

The integral molding eliminates any gap between the terminals and case to prevent solder wicking.

5. Case disengagement prevention

Reinforcing hardware (metal fittings) are integrated in the molding, which help prevent the case from disengaging with the terminals due to tough electric cable routing and load.

6. Cost countermeasure

Terminals and metal fittings are collectively integrated into the molding to reduce assembly cost.

Swing-Lock Structure explanatory drawing

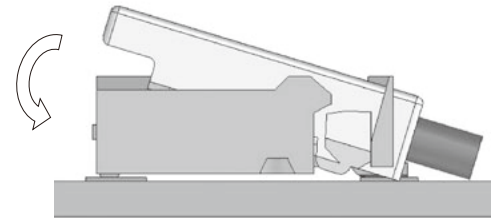

Before mating

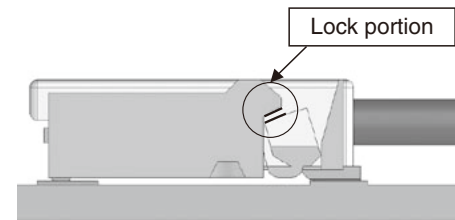

After mating

Contact Structure

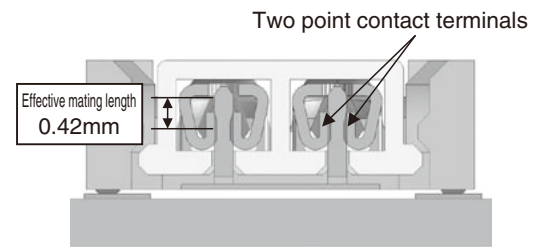

Cross-sectional view of the contact surface

DF57 Series●Substrate Twin (Pair) Cable Swing-Lock Connector for Low-Profile Power Source

■ Specifications

Rating	Current rating	AWG28	2pos. 2.5A	3pos. 2.0A	Operating temperature range -35°C to 85°C (Note 1) Operating humidity range 20% to 80%
		AWG30	1.5A	1.5A	
	Voltage rating	50V AC/DC			Storage temperature range -10°C to 60°C (Note 2) Storage humidity range 40% to 70% (Note 2)

Item	Specification	Conditions
1. Insulation resistance	1,000 MΩ min.	100 V DC
2. Withstanding voltage	No flashover or insulation breakdown	500 V AC / 1 minute
3. Contact resistance	10 mΩ max.	20 mV max., at 1 mA.
4. Vibration	No electrical discontinuity of 1 μs or longer No damage, cracks or parts dislocation.	Frequency: 10 to 55 Hz, single amplitude of 0.75 mm, 10 cycles, 3 direction
5. Shock	No electrical discontinuity of 1 μs or longer No damage, cracks or parts dislocation.	Acceleration of 490 m/s ² , 11 ms duration, sine half-wave, 3 cycles in each of the 3 axis
6. Humidity	Contact resistance: 20 mΩ max., No damage, Insertion resistance: 500MΩ min. cracks or parts dislocation.	96 hours at of 40 ±2°C, and humidity of 90 to 95%
7. Temperature cycle	Contact resistance: 20 mΩ max., Insulation resistance: 500 MΩ min. No damage, cracks or parts dislocation.	-55°C → 5 to 35°C → 85°C → 5 to 35°C Times: 30 min. → 3 min. → 2 min. to 3 min. → 30 min. → 2 min. to 3 min. 5 cycles
8. Durability	Contact resistance: 20 mΩ max., No damage, cracks or parts dislocation.	30 cycles
9. Resistance to soldering heat	No deformation of components affecting performance	Reflow: At the recommended temperature profile Manual soldering: 350°C for 3 seconds

Note 1. Includes temperature rise caused by current flow.

Note 2. The term "storage" refers to products stored for a long period prior to mounting and use.

The operating temperature and humidity range covers the non-conducting condition of installed connectors in storage, shipment or during transportation.

Note 3. Information contained in this catalog represents general requirements for this Series. Contact us for the drawings and specifications for a specific part number shown.

■ Material

Product	Part	Material	Finish	Remarks
Header	Insulator	LCP	Color:Black	UL94V-0
	Contacts	Brass	Tin Plated	—
Crimp socket	Insulator	PBT	Color:White	UL94V-0
Crimp contacts	Contacts	Phosphor bronze	Tin Plated	—

■Ordering information

●Header

DF **57** - ***** **P** - **1.2** **V**
 ① ② ③ ④ ⑤ ⑥

① Series name : DF	⑤ Contact pitch:1.2mm
② Series No. : 57	⑥ Termination section V: Straight SMT
③ Number of contacts:2, 3, 4, 5, 6	
④ Connector type P: Plug	

●Crimp socket

DF **57** - ***** **S** - **1.2** **C**
 ① ② ③ ④ ⑤ ⑥

① Series name : DF	⑤ Contact pitch:1.2mm
② Series No. : 57	⑥ Termination section C: Crimp
③ Number of contacts:2, 3, 4, 5, 6	
④ Connector type S: Crimp socket	

●Contacts

DF **57** - **2830** **SCF**
 ① ②

① Applicable conductor 2830: AWG# 28 to AWG# 30	② Packaging SCF: Female crimp contact / reel
--	---

DF57 Series●Substrate Twin (Pair) Cable Swing-Lock Connector for Low-Profile Power Source

Header(SMT)

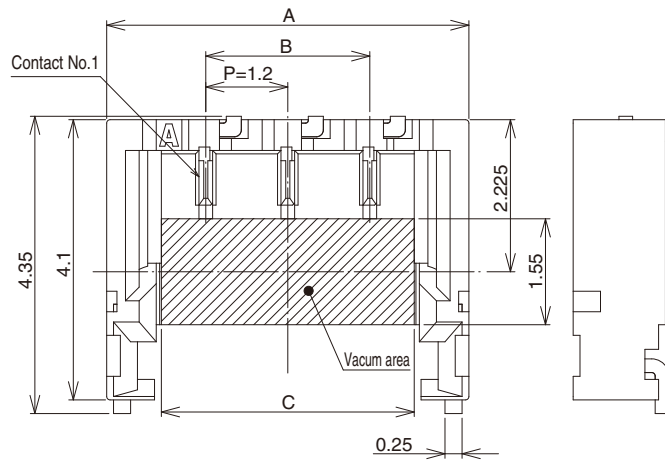
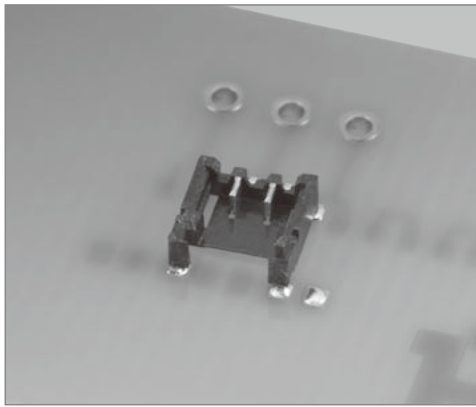

Recommended PCB mounting pattern(Thickness: 1.0mm)

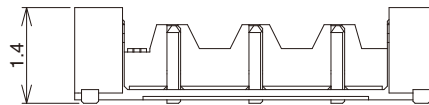
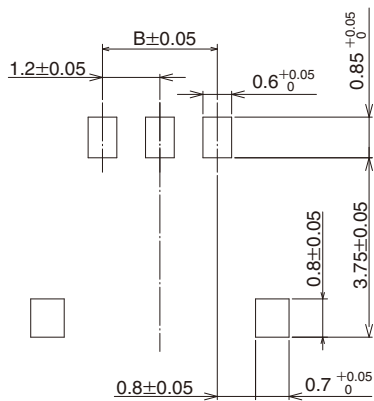

[Specification number]
(21):Tin plated, Embossed tape packaging (5,000 pieces per reel)

Unit : mm

Part Number	CL No.	Number of contacts	A	B	C
DF57-2P-1.2V(21)	666-0002-7-21	2	4.1	1.2	2.5
DF57-3P-1.2V(21)	666-0003-0-21	3	5.3	2.4	3.7
DF57-4P-1.2V(21)	666-0004-2-21	4	6.5	3.6	4.9
DF57-5P-1.2V(21)	666-0010-5-21	5	7.7	4.8	6.1
DF57-6P-1.2V(21)	666-0011-8-21	6	8.9	6.0	7.3

Note:Embossed tape reel packaging (5,000 pieces/reel).

●Packaging Specification

■DF57-2P-1.2V(21)
DF57-3P-1.2V(21)

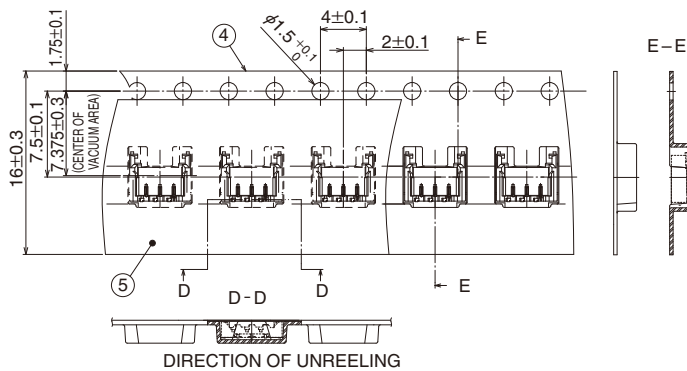

■DF57-4P-1.2V(21)
DF57-5P-1.2V(21)
DF57-6P-1.2V(21)

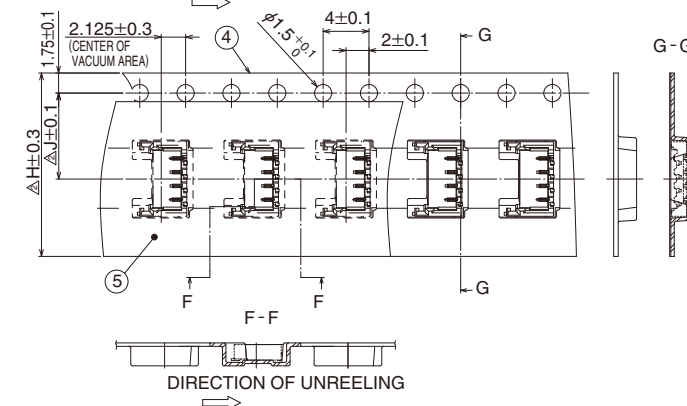

■Crimp socket

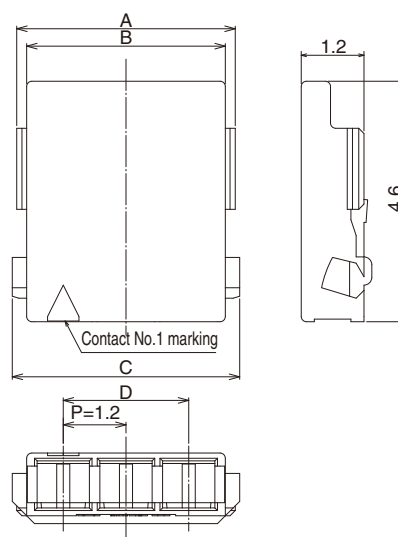
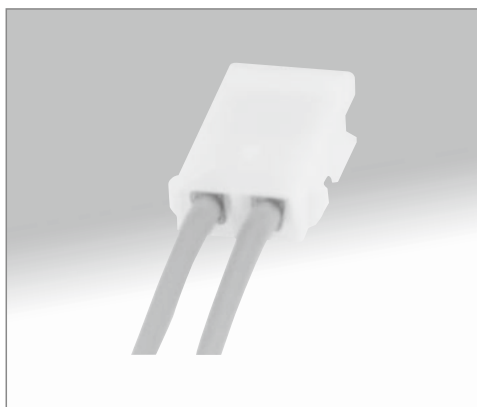

Unit : mm

Part Number	CL No.	Number of contacts	A	B	C	D
DF57-2S-1.2C	666-0005-5-00	2	2.98	2.6	3.15	1.2
DF57-3S-1.2C	666-0006-8-00	3	4.18	3.8	4.35	2.4
DF57-4S-1.2C	666-0007-0-00	4	5.38	5.0	5.55	3.6
DF57-5S-1.2C	666-0008-3-00	5	6.58	6.2	6.75	4.8
DF57-6S-1.2C	666-0009-6-00	6	7.78	7.4	7.95	6.0

[Packaging Specification]
 Blank: 1,000 pcs. per bag

Note 1. The quantity is delivered per bag (1,000 pcs.). If needed, please select and order the products per bag.

DF57 Series●Substrate Twin (Pair) Cable Swing-Lock Connector for Low-Profile Power Source

■Crimp contact

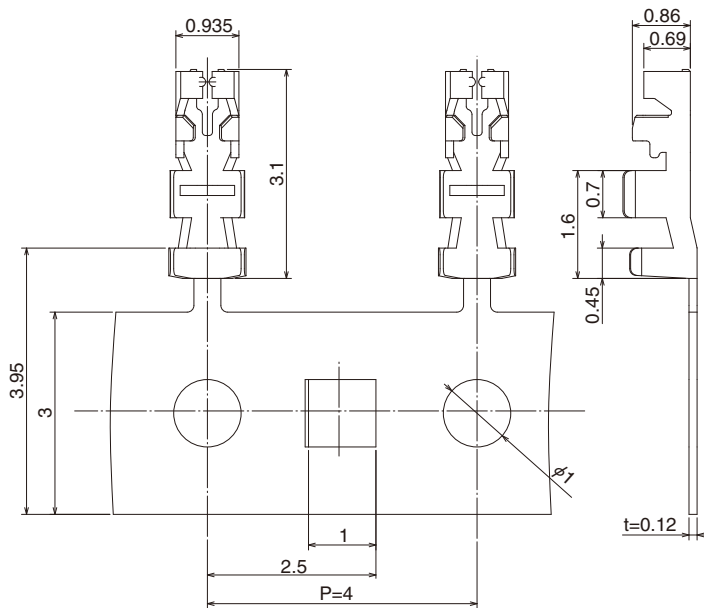

Part Number	CL No.	Packaging	Quantity	Finish
DF57-2830SCF	666-0001-4-00	Reel	40,000	Tin plated

[Packaging Specification]
Blank: Embossed tape packaging
(40,000 pieces per reel)

Note: Embossed tape reel packaging (40,000 pieces/reel).
Order by number of reels.

●Applicable wire (Tin plated annealed copper wire)

Wire size (Stranded wire conductor)	Jacket outer diameter
AWG28(7 / 0.127mm)	0.58mm
AWG30(7 / 0.102mm)	0.56mm

Note: When using other than the recommended wire, contact your nearest Hirose sales representative.

- Recommended cable
UL1571 (Thin wire)
- Strip length 1.0 to 1.4mm

■Tools

Type	Part Number	CL No.	Applicable contact
Applicator	AP105-DF57-2830S	CL901-4618-5-00	DF57-2830SCF
Press	CM-105	CL901-0005-4-00	—
Hand crimping tool	HT305/DF57-2830S	Under development	DF57-2830SCF
Contact extraction tool	DF-C-PO(B)	CL550-0179-2-00	DF57-2830SCF

Note: If any trouble has occurred due to tools other than the designated tool, Hirose bears no responsibility for any trouble.

■Usage Recommendations

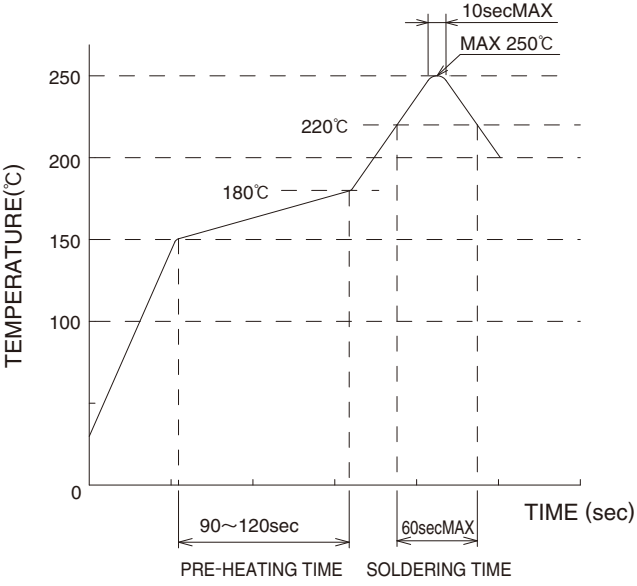
<p>1.Recommended temperature profile</p>	 <p>The temperature profiles are based on the above conditions. In individual applications the actual temperature may vary, depending on solder paste type, volume/thickness and board size/thickness. Consult your solder paste and equipment manufacturer for specific recommendations.</p>
<p>2.Recommended manual soldering</p>	<p>Manual soldering: 350°C ± 10°C for 3 seconds</p>
<p>3.Recommended screen thickness and open area ratio (Pattern area ratio)</p>	<p>Thickness: 0.1 mm Open area ratio: 100%</p>
<p>4.Board warpage</p>	<p>Maximum of 0.02mm at the connector center, with both ends of the connector as reference points.</p>
<p>5.Cleaning conditions</p>	<p>Cleaning is not recommended. When cleaning, please evaluate as if can deteriorate the performance including mechanical operation and environmental resistance.</p>
<p>6.Precautions</p>	<ul style="list-style-type: none"> ■When inserting crimp-type (solderless) terminals to crimping (solderless) sockets, to maintain reliable performance, please do not insert obliquely. ■DO NOT mate/un-mate non-terminated plugs with non-mounted receptacles. This may lead to damage or deformation of the contacts. ■Removal of the holding electric cable may cause damage so please be careful. ■DO NOT apply flux to the contact terminals when hand soldering the receptacle to the board. Wicking of the flux into the electrical contact areas may lead to connection failures. ■Slight discoloration on the insulating materials will not affect form, fit or function of the connectors. ■For operating suggestions on insertion and removal, please refer separately to the "DF57 Insertion and Removal Manual".

7. Insertion and removal operation method

Mating

- ① Determine position, fitting the external form ② Insert the cable side

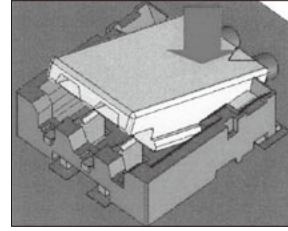
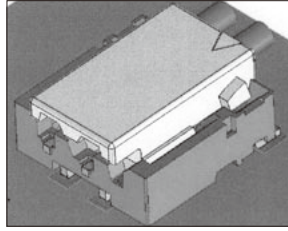

- ③ Push the contact portion side

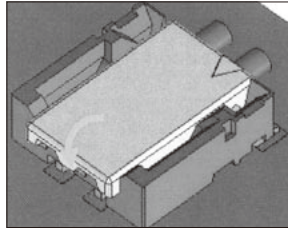

Un-mating

- ① Engage lever ② Pull up and release the simple lock

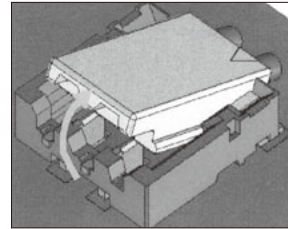
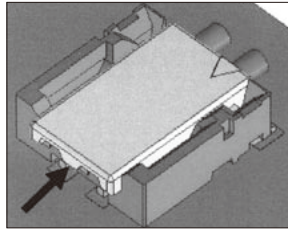

- ③ The reinforced lock is also released and the un-mating is complete

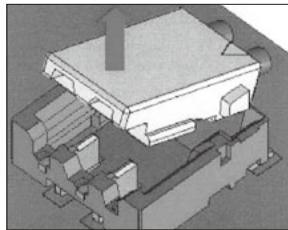

HRS

HIROSE ELECTRIC CO.,LTD.

5-23,OSAKI 5-CHOME,SHINAGAWA-KU,TOKYO 141-8587,JAPAN
PHONE: 81-3-3491-5300, FAX: 81-3-3495-5230
<http://www.hirose.com>
<http://www.hirose-connectors.com>