

# Si PIN photodiode S1223 series

For visible to IR, precision photometry

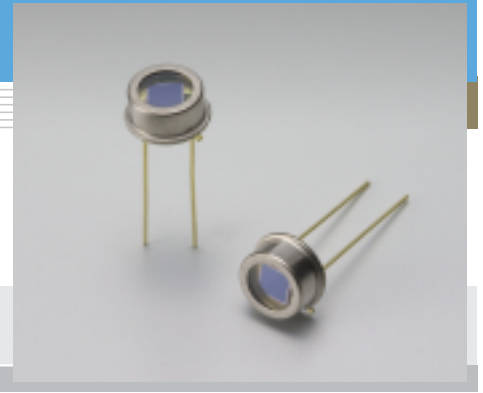

## Features

- High sensitivity
- High reliability
- High-speed response  
S1223:  $f_c=30$  MHz  
S1223-01:  $f_c=20$  MHz
- Low capacitance

## Applications

- Optical measurement equipment
- Analytical equipment, etc.

## General ratings

Parameter	Symbol	S1223	S1223-01	Unit
Window material	-	borosilicate glass		-
Package	-	TO-5		-
Active area size	A	2.4 × 2.8	3.6 × 3.6	mm
Effective active area	-	6.6	13	mm <sup>2</sup>

## Absolute maximum ratings

Parameter	Symbol	S1223	S1223-01	Unit
Reverse voltage	$V_R$ Max.	30		V
Power dissipation	P	100		mW
Operating temperature	$T_{opr}$	-40 to +100		°C
Storage temperature	$T_{stg}$	-55 to +125		°C

## Electrical and optical characteristics ( $T_a=25$ °C)

Parameter	Symbol	Condition	S1223			S1223-01			Unit
			Min.	Typ.	Max.	Min.	Typ.	Max.	
Spectral response range	$\lambda$		-	320 to 1100	-	-	320 to 1100	-	nm
Peak sensitivity wavelength	$\lambda_p$		-	960	-	-	960	-	nm
Photo sensitivity	S	$\lambda=\lambda_p$	-	0.6	-	-	0.6	-	A/W
		$\lambda=660$ nm	-	0.45	-	-	0.45	-	
		$\lambda=780$ nm	-	0.52	-	-	0.52	-	
		$\lambda=830$ nm	-	0.54	-	-	0.54	-	
Short circuit current	$I_{sc}$	100 $I_x$	5	6.3	-	10	13	-	$\mu$ A
Dark current	$I_D$	$V_R=20$ V	-	0.1	10	-	0.2	10	nA
Temp. coefficient of $I_D$	$T_{CID}$		-	1.15	-	-	1.15	-	times/°C
Cut-off frequency	$f_c$	$V_R=20$ V, -3 dB	-	30	-	-	20	-	MHz
Terminal capacitance	$C_t$	$V_R=20$ V, $f=1$ MHz	-	10	-	-	20	-	pF
Noise equivalent power	NEP	$V_R=20$ V, $\lambda=\lambda_p$	-	$9.4 \times 10^{-15}$	-	-	$1.3 \times 10^{-14}$	-	W/Hz <sup>1/2</sup>

## Spectral response

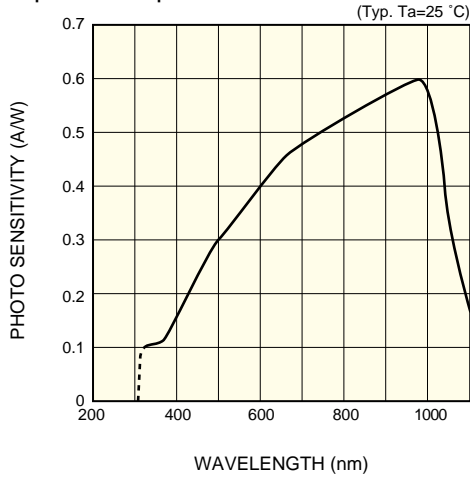

KPINB0143EA

## Photo sensitivity temperature characteristic

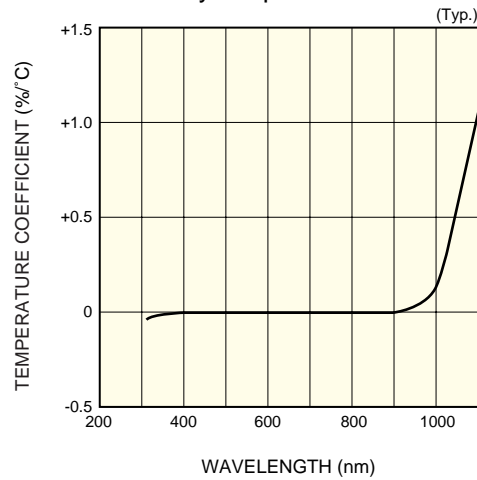

KPINB0144EA

## Dark current vs. reverse voltage

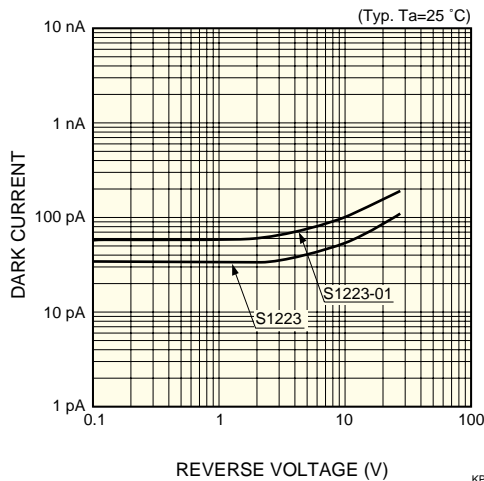

KPINB0145EA

## Terminal capacitance vs. reverse voltage

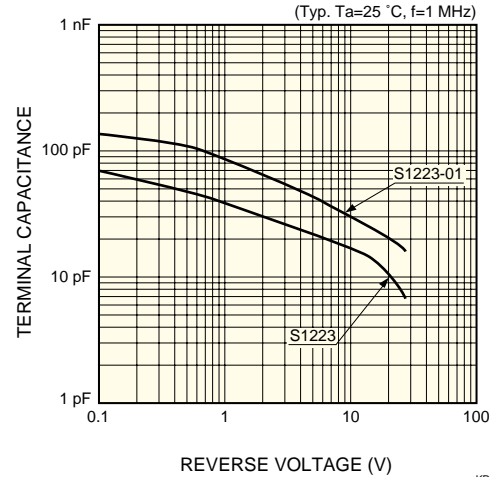

KPINB0146EA

## Dimensional outline (unit: mm)

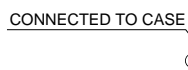
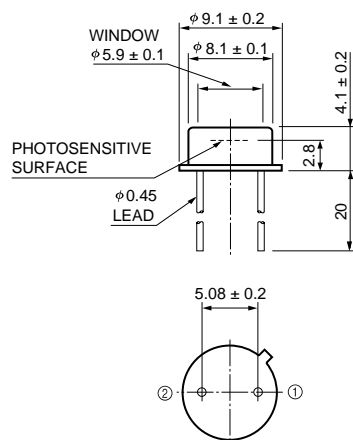

The glass window may extend a maximum of 0.2 mm above the upper surface of the cap.

KPINA0073EA

# HAMAMATSU

Information furnished by HAMAMATSU is believed to be reliable. However, no responsibility is assumed for possible inaccuracies or omissions. Specifications are subject to change without notice. No patent rights are granted to any of the circuits described herein. ©2006 Hamamatsu Photonics K.K.

HAMAMATSU PHOTONICS K.K., Solid State Division

1126-1 Ichino-cho, Higashi-ku, Hamamatsu City, 435-8558 Japan, Telephone: (81) 53-434-3311, Fax: (81) 53-434-5184, www.hamamatsu.com

U.S.A.: Hamamatsu Corporation: 360 Foothill Road, P.O.Box 6910, Bridgewater, N.J. 08807-0910, U.S.A., Telephone: (1) 908-231-0960, Fax: (1) 908-231-1218

Germany: Hamamatsu Photonics Deutschland GmbH: Arzbergerstr. 10, D-82211 Herrsching am Ammersee, Germany, Telephone: (49) 08152-3750, Fax: (49) 08152-2658

France: Hamamatsu Photonics France S.A.R.L.: 19, Rue du Saule Traipu, Parc du Moulin de Massy, 91882 Massy Cedex, France, Telephone: 33-(1) 69 53 71 00, Fax: 33-(1) 69 53 71 10

United Kingdom: Hamamatsu Photonics UK Limited: 2 Howard Court, 10 Twin Road, Welwyn Garden City, Hertfordshire AL7 1BW, United Kingdom, Telephone: (44) 1707-294888, Fax: (44) 1707-325777

North Europe: Hamamatsu Photonics Norden AB: Smidsvågen 12, SE-171 41 Solna, Sweden, Telephone: (46) 8-509-031-00, Fax: (46) 8-509-031-01

Italy: Hamamatsu Photonics Italia S.R.L.: Strada della Moia, 1/E, 20020 Arese, (Milano), Italy, Telephone: (39) 02-935-81-733, Fax: (39) 02-935-81-741