

# AN7345K

## Dual Record/Playback Pre-Amplifier IC for Double Cassette

### ■ Description

The AN7345K is a monolithic integrated circuit designed for double cassette, and built-in Dual-channel Record/Playback pre-amplifier including ALC function in the shrunk 24-DIL Pin Package.

### ■ Features

- Built-in equalizer SW circuit for Playback Amplifier
- Built-in Playback Amplifier input switching circuit for Double Cassette
- Wide operating supply voltage range :  
 $V_{CC(opr)} = 4V \sim 12V$

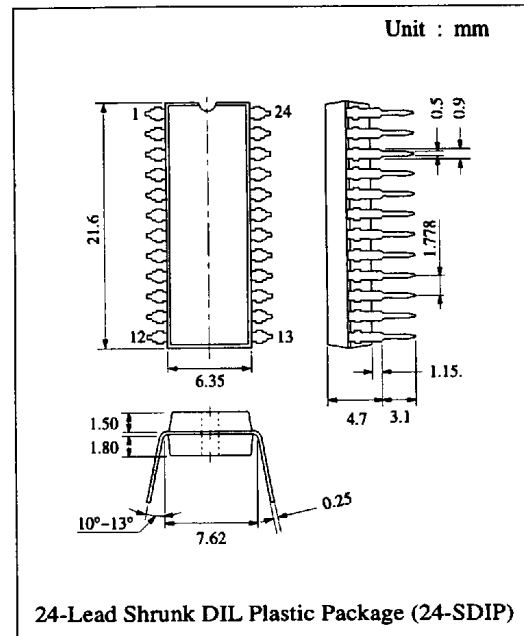

### ■ Block Diagram

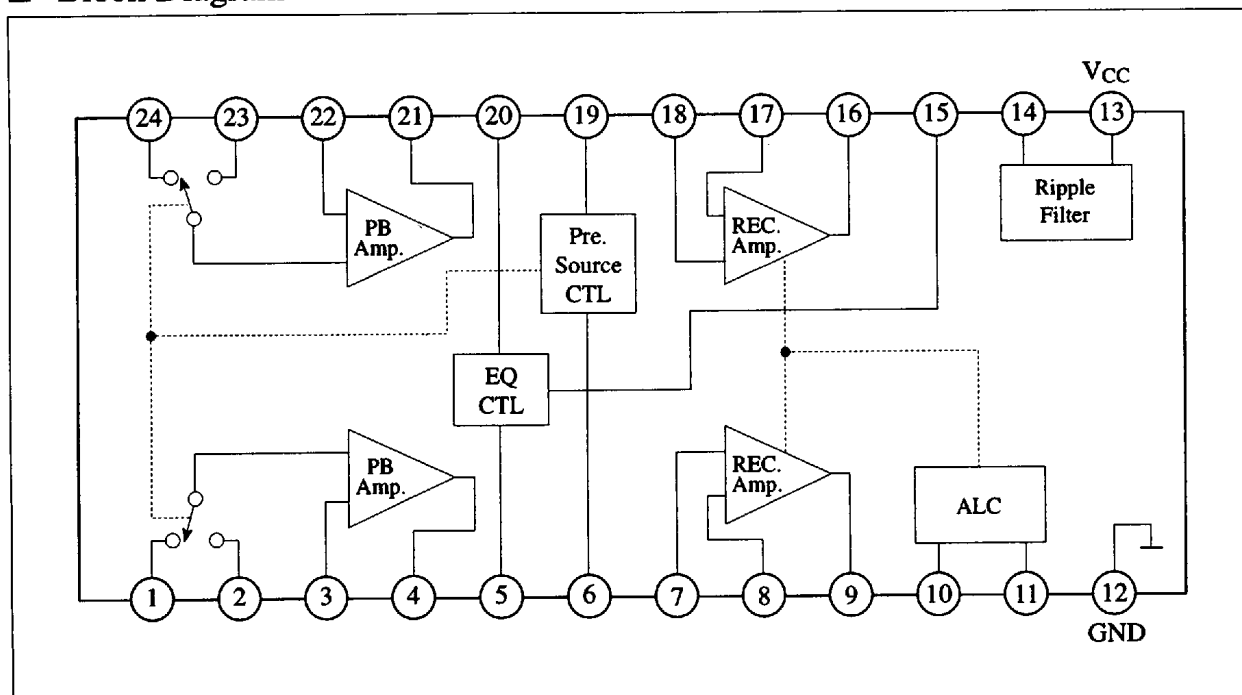

### ■ Absolute Maximum Ratings (Ta=25°C)

Item	Symbol	Rating	Unit
Supply Voltage	V <sub>CC</sub>	14	V
Supply Current	I <sub>CC</sub>	37	mA
Power Dissipation	P <sub>D</sub>	1000	mW
Operating Ambient Temperature	T <sub>opr</sub>	-20 ~ +75	°C
Storage Temperature	T <sub>stg</sub>	-55 ~ +150	°C

Operating Supply Voltage Range: V<sub>CC</sub> = 4.0V ~ 12.0V

### ■ Electrical Characteristics (V<sub>CC</sub>=5V, Ta=25°C)

Item	Symbol	Condition	min.	typ.	max.	Unit
No Signal Supply Current	I <sub>tot</sub>	V <sub>in</sub> = 0V	5.5	11	17.5	mA
<b>Playback Amp.</b>						
Input Noise Voltage	V <sub>ni(p)</sub>	R <sub>g</sub> = 2.2kΩ, DIN/AUDIO		1.3	2	μV
Open-Loop Gain	G <sub>VO(p)</sub>	f = 1kHz, V <sub>O</sub> = 0dBV	75	84		dB
Closed-Loop Gain	G <sub>VC(p)</sub>	f = 1kHz, V <sub>O</sub> = 0dBV		43		dB
Total Harmonic Distortion	THD <sub>(p)</sub>	f = 1kHz, V <sub>O</sub> = 0dBV		0.05	0.4	%
Max. Output Voltage	V <sub>O(p)</sub>	f = 1kHz, THD = 3%	0.9	1.4		V
Channel Balance	CB <sub>(p)</sub>	f = 1kHz, V <sub>O</sub> = 0dBV	-1.5	0	1.5	dB
Channel Crosstalk	CT <sub>C(p)</sub>	f = 1kHz, V <sub>O</sub> = 0dBV, R <sub>g</sub> = 2.2kΩ	55	65		dB
Source Crosstalk	CT <sub>S(p)</sub>	f = 1kHz, V <sub>O</sub> = 0dBV, R <sub>g</sub> = 2.2kΩ	55	65		dB
<b>REC. Amp.</b>						
Output Noise Voltage	V <sub>no(R)</sub>	R <sub>g</sub> = 0Ω, DIN/AUDIO		350	900	μV
Open-Loop Gain	G <sub>VO(R)</sub>	f = 1kHz, V <sub>O</sub> = 0dBV	70	80		dB
Closed-Loop Gain	G <sub>VC(R)</sub>	f = 1kHz, V <sub>O</sub> = 0dBV		50		dB
Total Harmonic Distortion	THD <sub>(R)</sub>	f = 1kHz, V <sub>O</sub> = 0dBV		0.16	0.5	%
Max. Output Voltage	V <sub>O(R)</sub>	f = 1kHz, THD = 3%	1.4	1.8		V
Channel Crosstalk	CT <sub>(R)</sub>	f = 1kHz, V <sub>O</sub> = 0dBV, R <sub>g</sub> = 0Ω	50	63		dB
<b>ALC</b>						
ALC Start Voltage	V <sub>ALC</sub>	f = 1kHz, V <sub>in</sub> = -40dBV	0.78	1.03	1.28	V
ALC Range (*1)	W <sub>ALC</sub>	f = 1kHz, V <sub>O</sub> = 0dBV, R <sub>g</sub> = 5.6kΩ	35			dB
ALC Channel Balance	CB <sub>(A)</sub>	f = 1kHz, V <sub>O</sub> = -40dBV, R <sub>g</sub> = 5.6kΩ	-2	0	2	dB

Note : (\*1) ALC Range is the input range from V<sub>in</sub> = -40dB until the output THD becomes 3%

■ Application Circuit - 1 (With Electronic Switch)

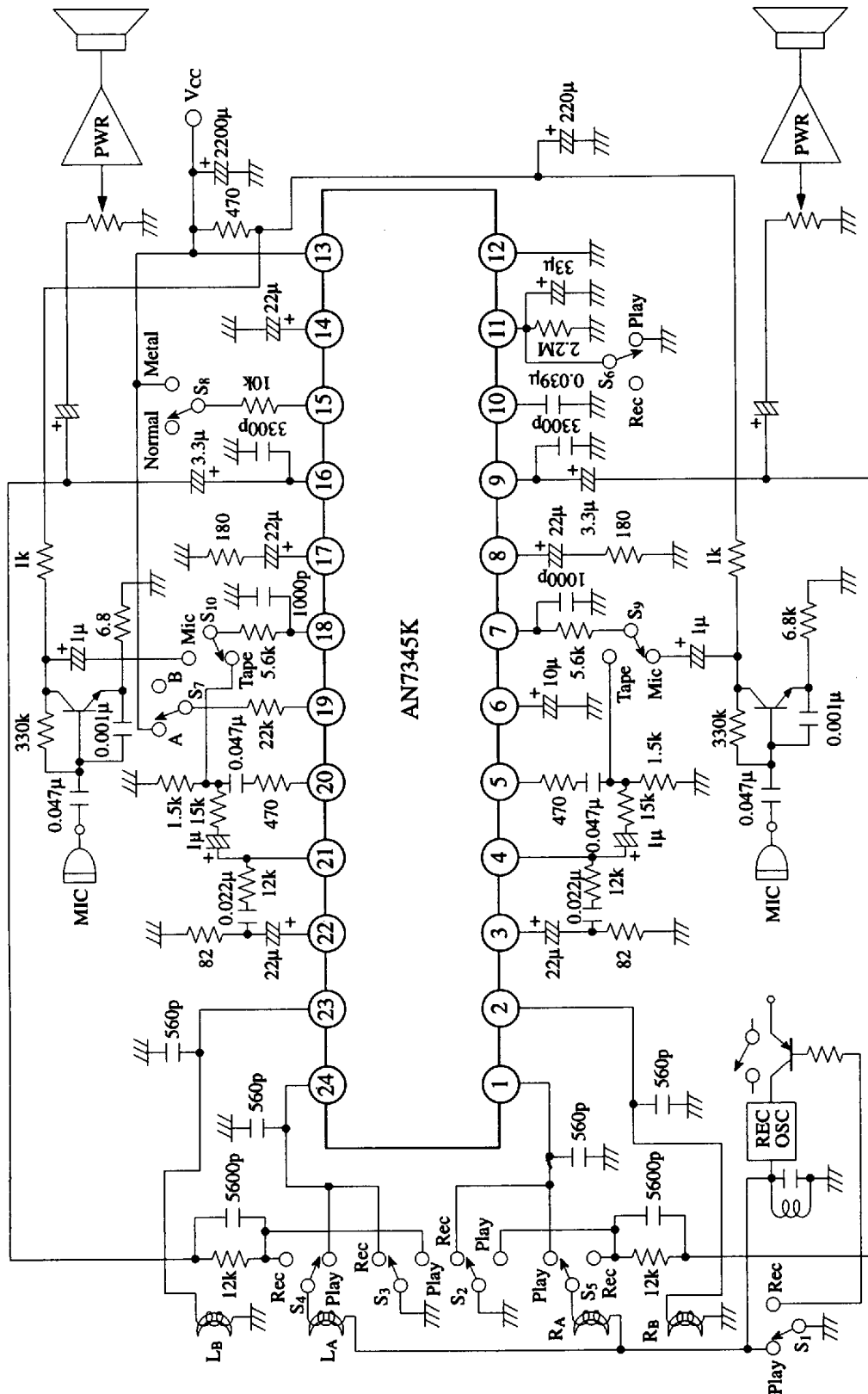





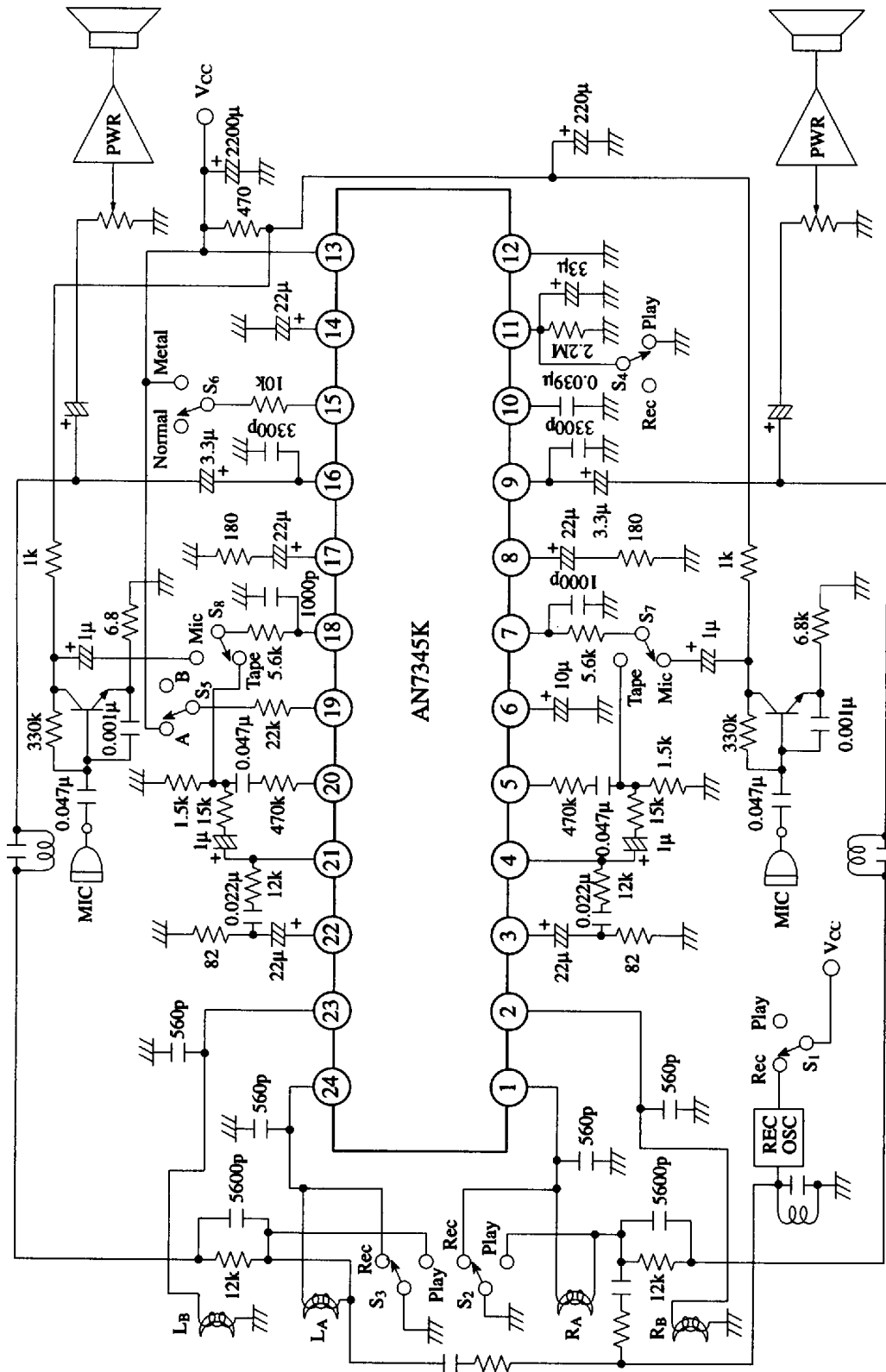

- S<sub>1</sub> - S<sub>6</sub> : Play / Rec switching
  - S<sub>7</sub> : A / B head input signal switching
  - S<sub>8</sub> : Normal / Metal, Equalizer switching
  - S<sub>9, 10</sub> : Tape Rec / MIC Rec switching
- (Note) More than 5.6kΩ is necessary for input of Pin 7, Pin 18

Application Circuit - 2

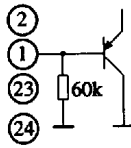
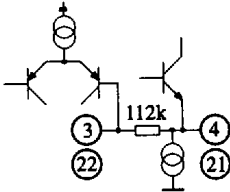

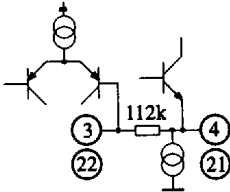
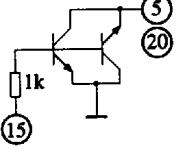
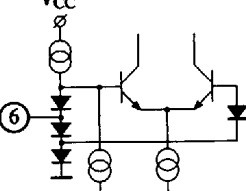
- S1 - S4 : Play / Rec switching
  - S5 : A / B head input signal switching
  - S6 : Normal / Metal, Equalizer switching
  - S7, 8 : Tape Rec / MIC Rec switching
- (Note) More than 5.6kΩ is necessary for input of Pin 7, Pin 18

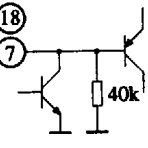
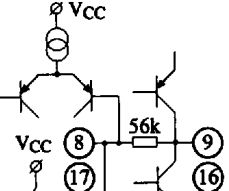
## ■ Pin Descriptions

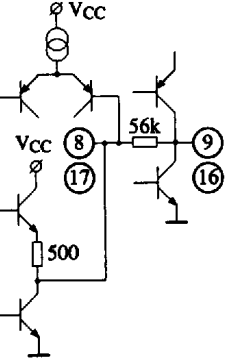
Pin No.	Pin Name	Typical Waveform	Equivalent Circuit	Description
1	Channel 1 Playback Amp. Input (1)	 AC 3.7mV		Playback amp. input.
24	Channel 2 Playback Amp. Input (1)			
2	Channel 1 Playback Amp. Input (2)			
23	Channel 2 Playback Amp. Input (2)			
3	Channel 1 Playback Amp. Negative Feedback	DC = 0.7V		Playback amp. feedback.
22	Channel 2 Playback Amp. Negative Feedback			
4	Channel 1 Playback Amp. Output	 AC 1V		Playback amp. output.
21	Channel 2 Playback Amp. Output			
5	Channel 1 Equalizer			Playback amp. Equalizer switching.  (more than) 0.7V - Equalizer pin, GND short.
20	Channel 2 Equalizer			
15	Equalizer Control			
6	Pre-amp. Input Switching Time Constant	DC = 1.4V (Pin 19 High)  DC = 0.2V (Pin 19 open)		Connect capacitor which determines PB input switching time constant.
7	Channel 1 Rec. Amp. Input	 AC 1.9 mV		Rec. amp. input.
18	Channel 2 Rec. Amp. Input			
8	Channel 1 Rec. Amp. Negative Feedback	DC = 0.7V		Rec. amp. feedback.
17	Channel 2 Rec. Amp. Negative Feedback			
9	Channel 1 Rec. Amp. Output	 AC 0.5 mV		Rec. amp. output.
16	Channel 2 Rec. Amp. Output			

■ Pin Descriptions (Continue)

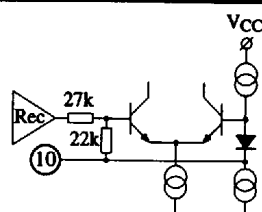
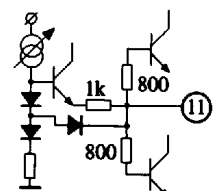
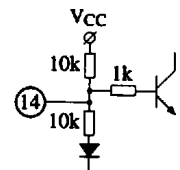
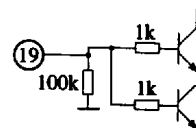
Pin No.	Pin Name	Typical Waveform	Equivalent Circuit	Description
10	Low CUT	DC ≈ 2.5V		ALC comparator circuit reference voltage.
11	ALC Time Constant	Follow input signal		Low-pass filter pin.
12	GND			Main Circuit GND.
13	Positive Supply Pin	DC = 5V		Main Circuit +Vcc.
14	V <sub>REF</sub>	DC = 3.2V		
19	Pre-amp. Input Switching Control			Pre-amp. (T1/T2) input switching control. (more than) 0.7V - T1 open - T2

■ Characteristics Curve

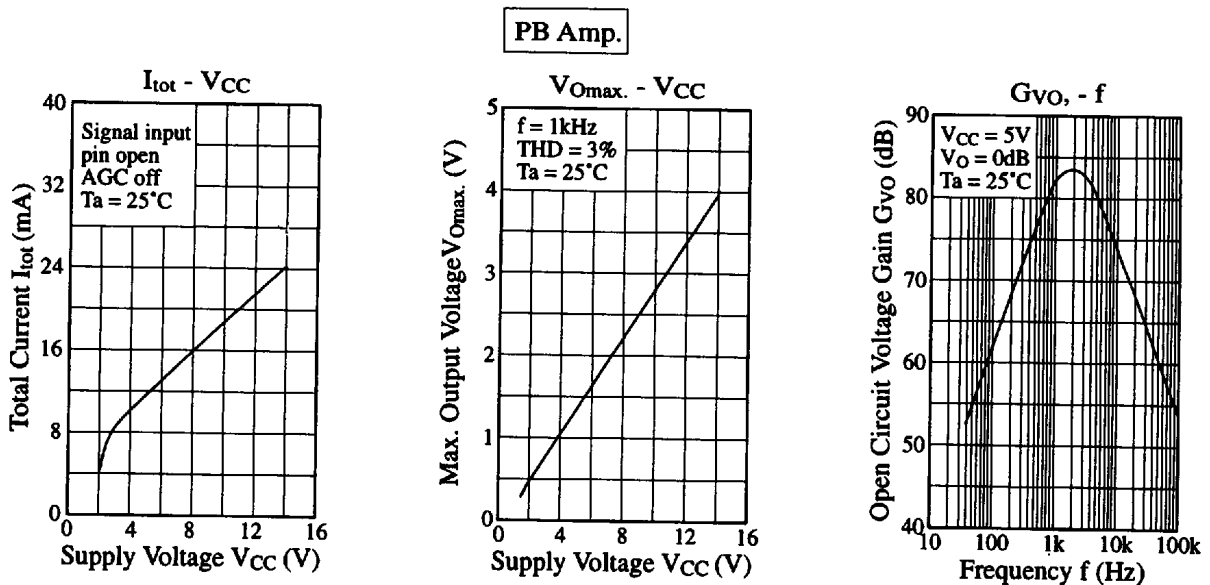

■ Characteristics Curve (Continue)

PB Amp.

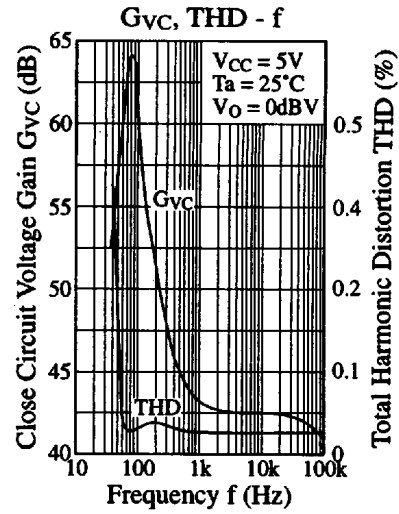
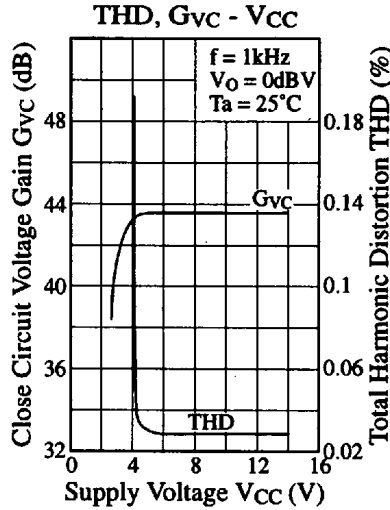
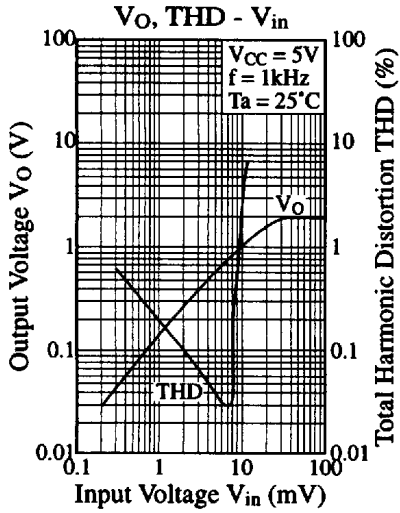

Equalizer

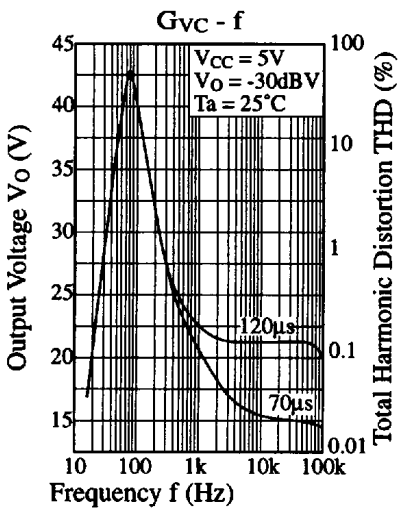

Rec Amp.

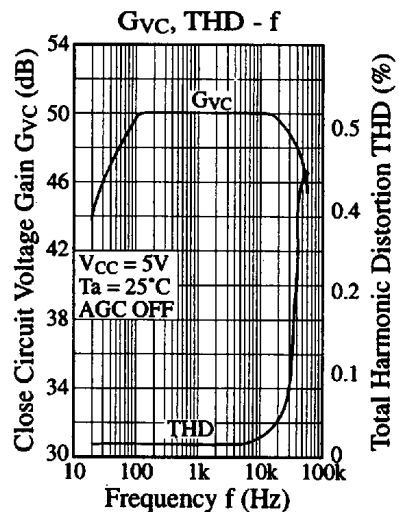
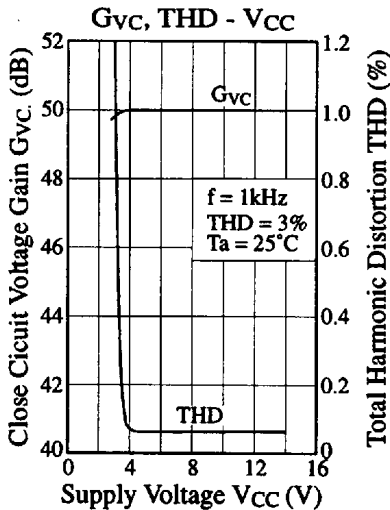
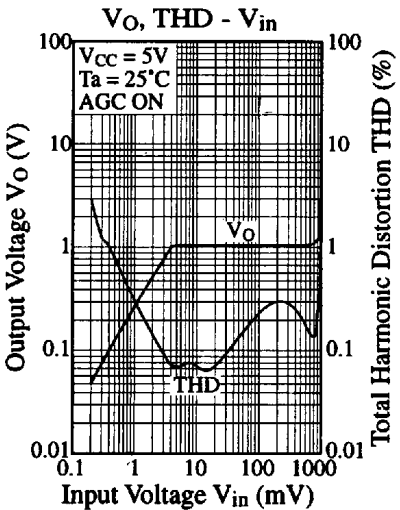
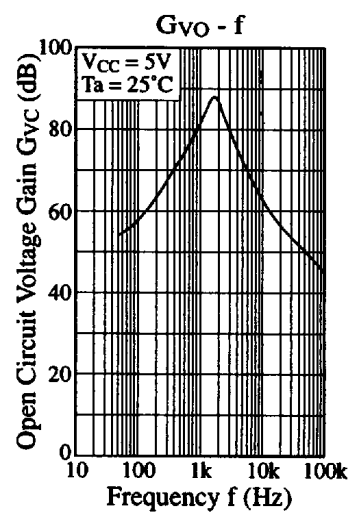
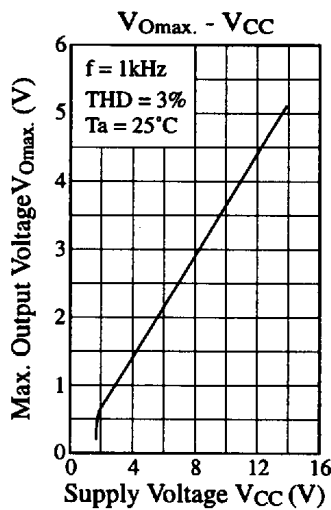

## ■ Application Notes

### (1) ALC Detector

The detector is built-in. ALC is cut-off during play-back by shorting Pin 11 to Ground. Pin 11 is connected with a condenser  $33\mu\text{F}$  and a resistor  $2.2\text{M}\Omega$  when this condenser charges up to about  $1.4\text{V}$  during ALC operation, the output AC Voltage of the recording amps are maintained at  $1\text{V}$ . (Frequency =  $1\text{kHz}$ ,  $V_{\text{CC}} = 5.0\text{V}$ , external resistor at Rec-amp. inputs =  $5.6\text{k}\Omega$ ).

The ALC attack time is about  $40\text{ms}$ , while the ALC recovery time is about  $8\text{s}$ . These were found experimentally using the above conditions.

### (2) Tape-Type Equalisation Control

When voltage at Pin 15 is 'High', tape playback response is for metal ( $70\mu\text{s}$ ). When voltage at Pin 15 is 'Low', tape playback response is for normal tape ( $120\mu\text{s}$ ). When voltage at Pin 15 is 'High', the internal switches at Pin 5 and 20 are shorted to Ground. Otherwise when Pin 15 is 'Low', these switches are opened.

Range of safe operating 'High' voltage for Pin 15 :  $1.0\text{V} \leq \text{limits} \leq 12.0\text{V}$

There are  $1\text{k}\Omega$  resistors internal at Pin 15 to limit the current. However, it is advisable to put an external resistor of  $10\text{k}\Omega$  to reduce any switching noise.

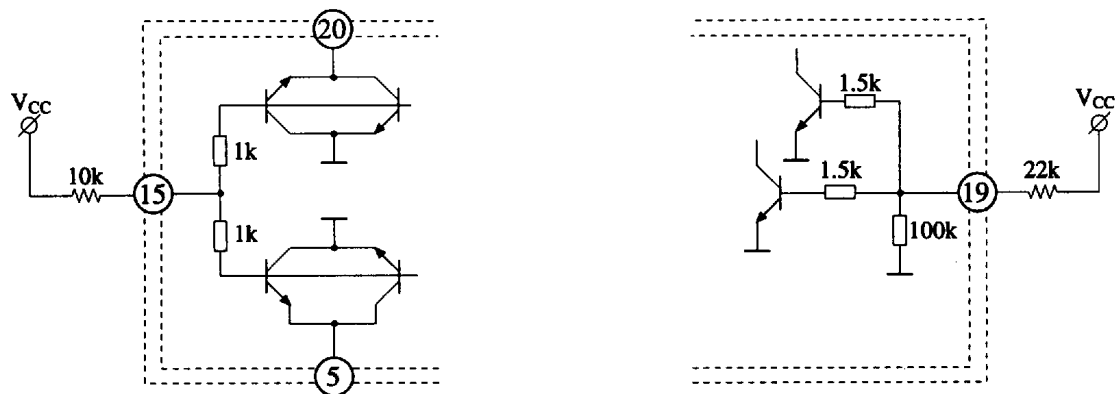

### (3) Pre-Source Control

When the voltage at Pin 19 is 'High', input signals at Pin 1 and 24 are selected for the pre-amps. When the voltage at Pin 19 is 'Low', input signals at Pin 2 and 23 are selected.

Similarly for safe operation 'High' voltage at Pin 19 :  $1.0\text{V} \leq \text{limits} \leq 12\text{V}$

Also, if possible, use an external  $22\text{k}\Omega$  resistor at Pin 19 to reduce any switching noise.